



**Concealed hinges for the cabinet
and furniture industries**

***Charnières invisibles pour l'industrie
du meuble***

SALICE

Index • Index

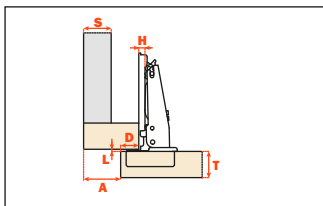

General information
Informations générales

page 4
page 4



100 series Hinges shallow cup
Charnières Série 100 pour portes d'épaisseur réduite

page 12
page 12



200 series Hinges
Charnières Série 200

page 13
page 13

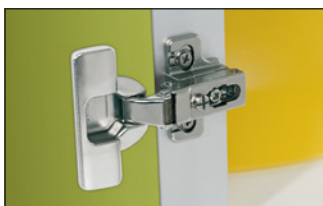

300 series Hinges with small operating profile
Charnières Série 300 avec encombrement en profondeur réduit

page 24
page 24

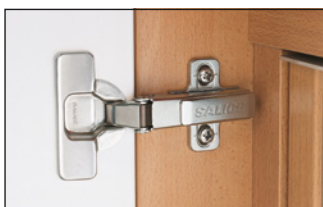

800 series
Charnières Série 800

page 25
page 25



Universal hinges for wood doors with special profiles
Charnières Universelles pour portes moulurées en bois

page 26
page 26



Single pivot hinge • 270° opening
Charnières à un axe • Ouverture à 270°

page 30
page 30



F series Hinges for thick doors up to 1-1/2"
Charnières Série F pour portes de forte épaisseur jusqu'à 1-1/2"

page 34
page 34

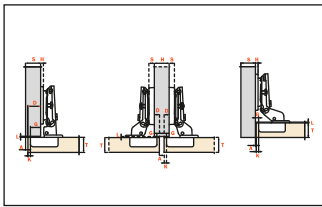

Overlay charts
Graphiques de recouvrement

page 35
page 35



Mounting plates
Embases

page 39
page 39

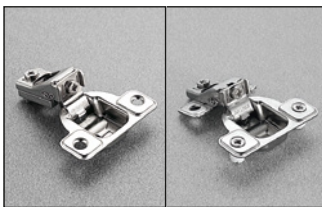

S series "Face frame" EXCENTRA - EXCENTHREE Hinges
Charnières Série S "Face frame" EXCENTRA - EXCENTHREE

page 53
page 53



Accessories
Accessoires

page 58
page 58



Push self opening hinges
Système Push pour l'ouverture de portes sans poignée

page 61
page 61

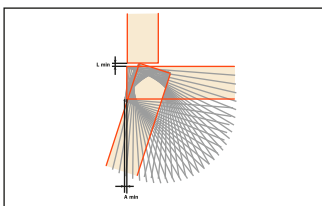

Minimum reveal charts
Tableaux avec jeu nécessaire pour l'ouverture de la porte

page 77
page 77



Titanium finish
Finition titane

page 83
page 83

Table of contents
Index des références

page 86
page 86

General information • Informations générales

Boring Pattern - Series 200, 100, 300, universal hinges, S and 800

K = Boring distance from the edge of the door:

94°	3 to 9 mm
105°	3 to 6 mm
106°	2.5 mm (Face Frame)
110°	3 to 6 mm
120°	3 to 6 mm
155°	3 to 9 mm
165°	3 to 8 mm

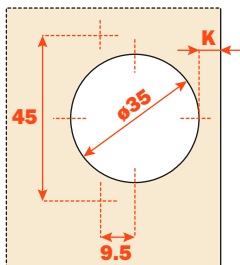

Screw-in.
A visser

Schéma de perçage - Série 200, 100, 300, charnières universelles, S et 800

K = Distance de perçage :

94°	3 à 9 mm
105°	3 à 6 mm
106°	2.5 mm (Face Frame)
110°	3 à 6 mm
120°	3 à 6 mm
155°	3 à 9 mm
165°	3 à 8 mm

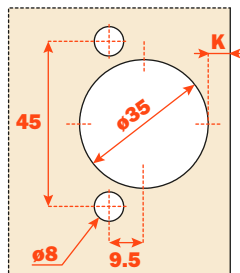

Press-in - Rapido - Logica Tool free
A pression - Rapido - Logica, sans outils

System 37x32 standard drilling for cruciform plates

Perçage standard 37x32 pour embases cruciformes

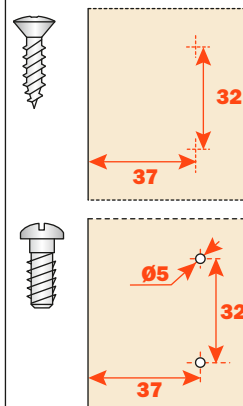

Recommended number of hinges per door.

Maximum door weight.

Door width	20lb	40lb	60lb
ø 40 mm	2	3	4
ø 35 mm	2	3	4
No. of hinges	2	3	4

The number of hinges required depends on the size, weight and material of the door. The distance between the top and bottom must be greater than the width of the door. Additional hinges should be added if doors are near the border line of size or weight chart. Use the diagram below to determine number of hinges needed.

Nombre de charnières requises par porte.

Poids maximum de la porte

Door width	20lb	40lb	60lb
ø 40 mm	2	3	4
ø 35 mm	2	3	4
Nombre de charnières	2	3	4

Le nombre de charnières nécessaires dépend des dimensions, du poids et de la matière de la porte. La distance entre le chapeau et la base doit être supérieure à la largeur de la porte. Des charnières supplémentaires doivent être ajoutées si les portes sont proches aux limites du tableau des dimensions ou du poids. Utilisez le schéma ci-dessous pour déterminer le nombre de charnières nécessaires.

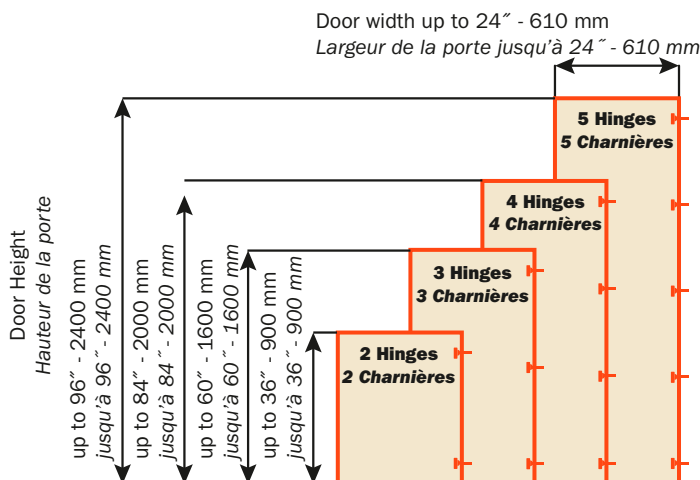

Millimeter to inch equivalents • Correspondance entre pouce et millimètre

mm	1	1.5	2	3	4	5	5.5	6	7	8	9	9.5	10	11	12	13
inch	1/32"	1/16"	3/32"	1/8"	5/32"	3/16"	7/32"	1/4"	9/32"	5/16"	11/32"	3/8"	13/32"	7/16"	15/32"	1/2"
mm	14	15	16	17	17.5	18	19	20	20.5	21	22	23	24	24.5	25.4	
inch	9/16"	19/32"	5/8"	21/32"	11/16"	23/32"	3/4"	25/32"	13/16"	27/32"	7/8"	29/32"	15/16"	31/32"	1"	

How to calculate your overlay using the 100/200 series:
Comment calculer le recouvrement en utilisant les Série 100/200 :

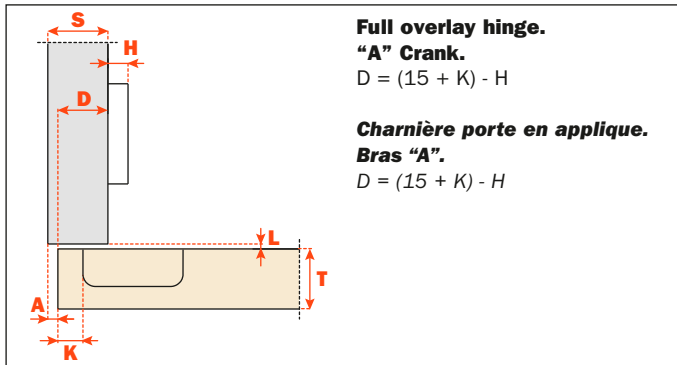

Full overlay hinge.
"A" Crank.
 $D = (15 + K) - H$

Charnière porte en applique.
Bras "A".
 $D = (15 + K) - H$

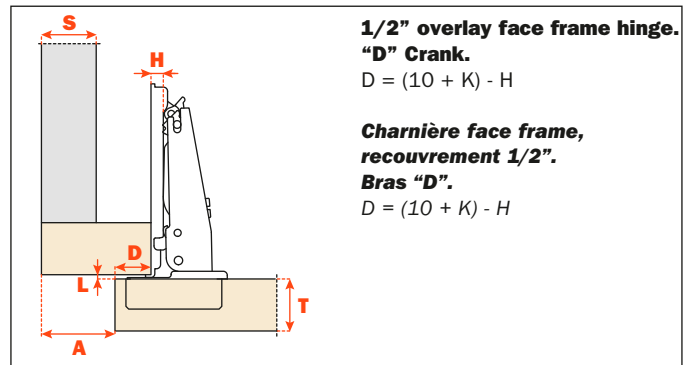

1/2" overlay face frame hinge.
"D" Crank.
 $D = (10 + K) - H$

Charnière face frame,
recouvrement 1/2".
Bras "D".
 $D = (10 + K) - H$

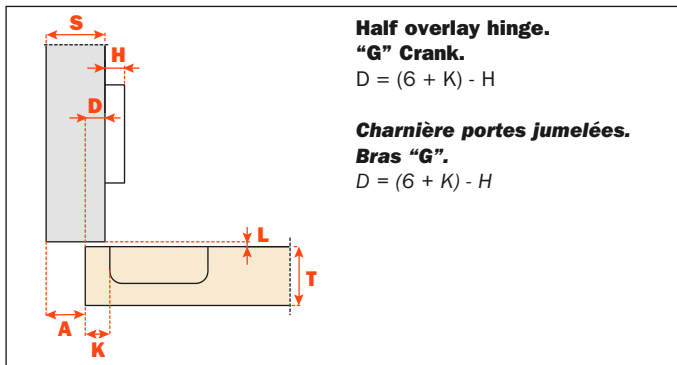

Half overlay hinge.
"G" Crank.
 $D = (6 + K) - H$

Charnière portes jumelées.
Bras "G".
 $D = (6 + K) - H$

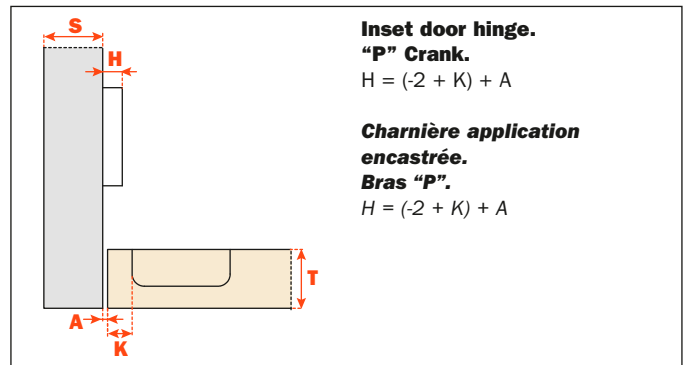

Inset door hinge.
"P" Crank.
 $H = (-2 + K) + A$

Charnière application
encastrée.
Bras "P".
 $H = (-2 + K) + A$

Overlay = (constant + drilling distance) - plate height.

For special applications, do not hesitate to contact our customer service department.

Recouvrement = (constante + distance de perçage) - hauteur

embase. N'hésitez pas à demander toutes les explications nécessaires à notre service d'assistance technique.

Boring Pattern - F series • Schéma de perçage - Série F

How to calculate your overlay:

Comment calculer le recouvrement :

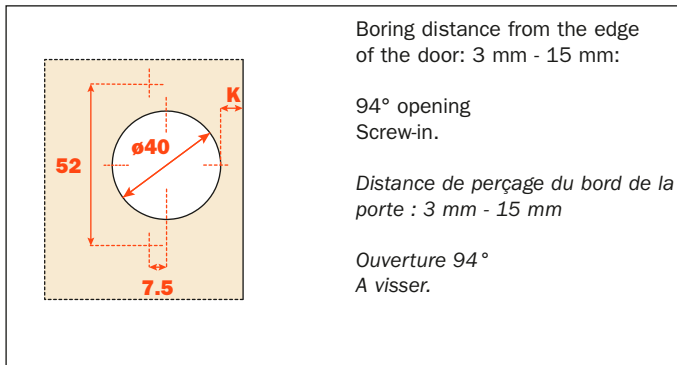

Boring distance from the edge of the door: 3 mm - 15 mm:

94° opening
 Screw-in.

Distance de perçage du bord de la porte : 3 mm - 15 mm

Ouverture 94°
 A visser.

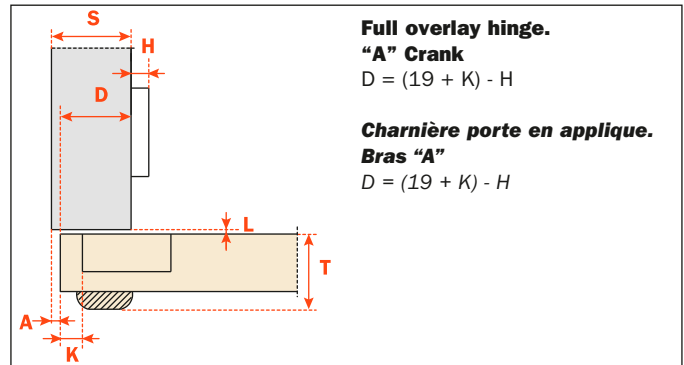

Full overlay hinge.
"A" Crank
 $D = (19 + K) - H$

Charnière porte en applique.
Bras "A"
 $D = (19 + K) - H$

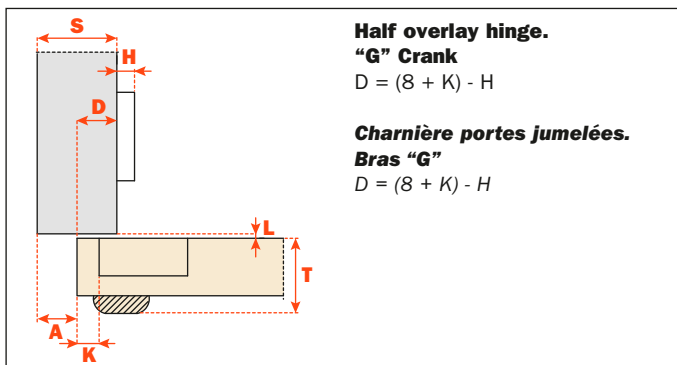

Half overlay hinge.
"G" Crank
 $D = (8 + K) - H$

Charnière portes jumelées.
Bras "G"
 $D = (8 + K) - H$

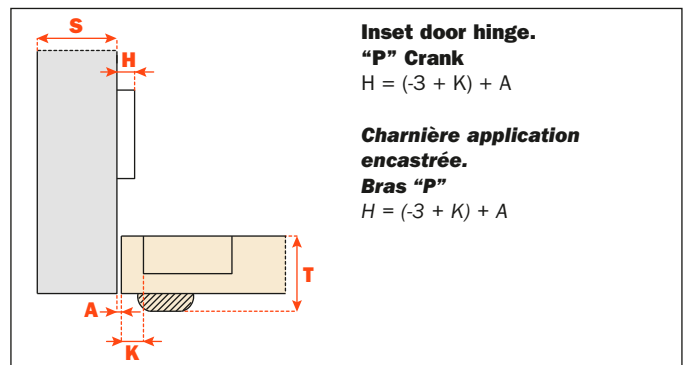

Inset door hinge.
"P" Crank
 $H = (-3 + K) + A$

Charnière application
encastrée.
Bras "P"
 $H = (-3 + K) + A$

Abbreviations • Abréviations

Application with full overlay door.
Application avec porte en applique.

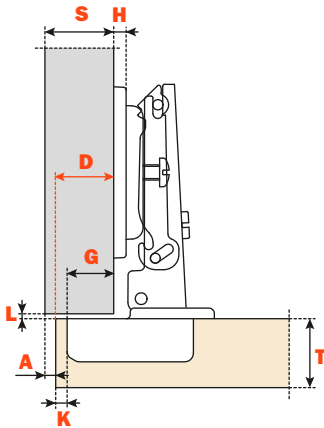

- S** = Thickness of the cabinet side - *Epaisseur du côté*
- D** = Required door overlay - *Recouvrement désiré*
- T** = Door thickness - *Epaisseur de la porte*
- K** = Drilling distance - *Distance de perçage*
- A** = Reveal - *Jeu*
- L** = Gap between door and cabinet - *Distance entre la porte et le côté*
- H** = Height of the mounting plate - *Hauteur de l'embase*
- G** = Hinge constant - *Caractéristique de la charnière*

Whatever door overlay is required, you can select from our series the combination of both the type of hinge arm and the thickness of mounting plate necessary to solve your construction problem while avoiding the need to stock unnecessary components.

Quel que soit le recouvrement de la porte sur le côté que vous désirez, vous pouvez compter sur une large gamme de bras droits, de bras coudés, de hauteurs d'embases, qui vous permettront de réaliser votre projet, en gérant de façon rationnelle votre stock.

Application with half overlay door.
Application avec portes jumelées.

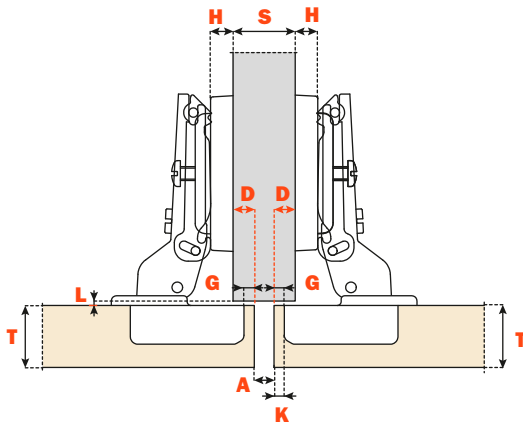

Application with inset door.
Application avec porte rentrante.

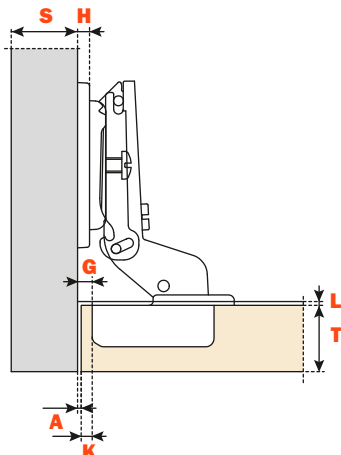

- S** = Thickness of the cabinet side - *Epaisseur du côté*
- T** = Door thickness - *Epaisseur de la porte*
- K** = Drilling distance - *Distance de perçage*
- A** = Reveal - *Jeu*
- L** = Gap between internal face of door and internal cabinet elements (e.g. shelves, drawers, etc.)
Distance intérieure de la porte/éléments à l'intérieur du meuble (consoles, tiroirs, etc.)
- H** = Height of the mounting plate - *Hauteur de l'embase*
- G** = Hinge constant - *Caractéristique de la charnière*

Whatever door overlay is required, you can select from our series the combination of both the type of hinge arm and the thickness of mounting plate necessary to solve your construction problem while avoiding the need to stock unnecessary components.

Quel que soit le recouvrement de la porte sur le côté que vous désirez, vous pouvez compter sur une large gamme de bras droits, de bras coudés, de hauteurs d'embases, qui vous permettront de réaliser votre projet, en gérant de façon rationnelle votre stock.

Height adjustment • Please use #2 Pozidrive screwdriver for all screws
Réglage vertical • Utiliser le tournevis POZIDRIVE n° 2 pour toutes les vis

Traditional height adjustment.

By loosening the two fixing screws it is possible to adjust the door vertically by ± 2 mm. The elongated holes allow the mounting plate to slide freely in both directions. The screws must be retightened.

Réglage vertical traditionnel.

En dévissant les deux vis de fixation, il est possible de régler verticalement la porte ± 2 mm. Les trous ovales permettent le glissement de l'embase dans les deux sens. Une fois l'opération terminée, les vis doivent être resserrées.

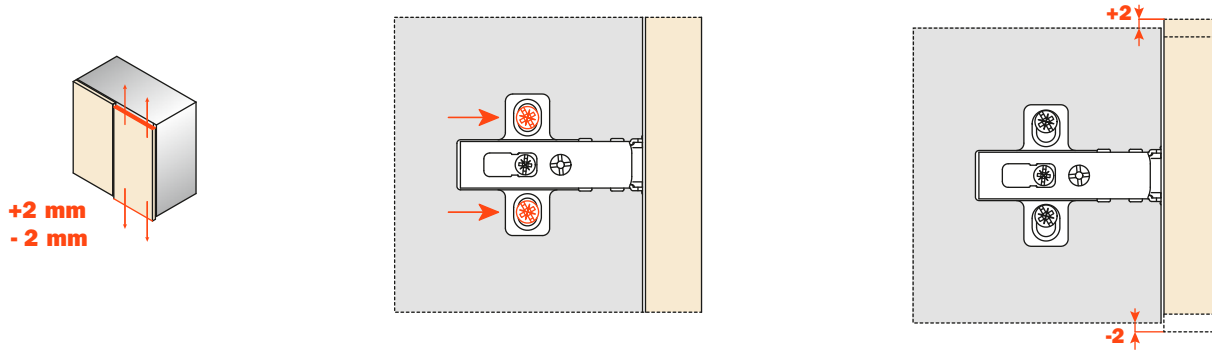

Height adjustment with Domi snap-on mounting plates, model BARxR.

Height adjustment is made without loosening any screws. The door can be moved vertically ± 2 mm simply by rotating the cam adjuster incorporated in this series of mounting plates.

Réglage vertical avec embases Domi modèle BARxR -

Il est possible d'effectuer un réglage vertical de la porte de ± 2 mm par une vis excentrique, sans avoir à dévisser une seule vis.

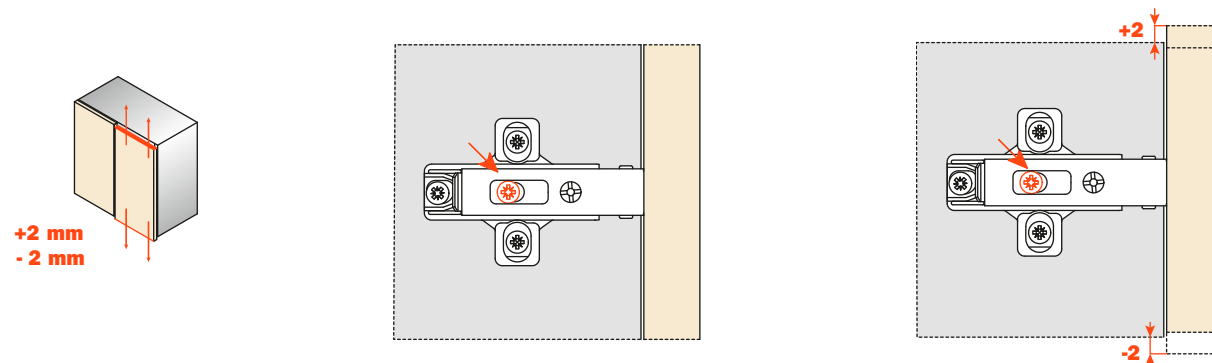

Height adjustment by cam • Réglage vertical par vis excentrique

Height adjustment with DOMI snap-on mounting plates, model BAPxR.

Height adjustment is made without loosening any screws. The door can be moved vertically ± 2 mm simply by rotating the cam adjuster incorporated in this series of mounting plates.

Réglage vertical avec embases Domi modèle BAPxR -

Il est possible d'effectuer un réglage vertical de la porte de ± 2 mm par une vis excentrique, sans avoir à dévisser une seule vis.

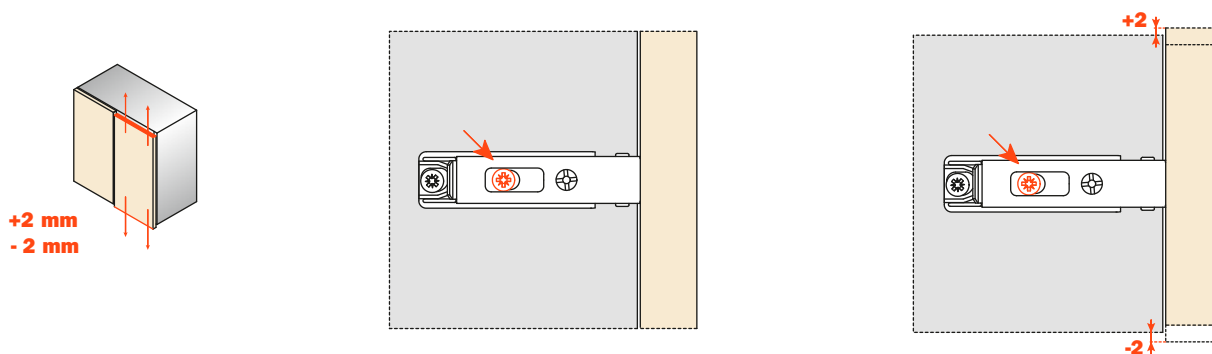

Height adjustment by cam • Réglage vertical par vis excentrique

Depth adjustment • Please use #2 Pozidrive screwdriver for all screws Réglage frontal • Utiliser le tournevis POZIDRIVE n° 2 pour toutes les vis

Traditional depth adjustment.

The hinge fixing screw is loosened and a key hole on the arm of the hinge enables the door to be adjusted out by +2.8 mm. The fixing screw must be retightened.

Réglage frontal traditionnel

Il est possible d'effectuer un réglage frontal de la porte de +2.8 mm. Le trou ovale placé sur la plaquette de l'embase permet le glissement de la charnière. Une fois l'opération terminée, la vis doit être resserrée.

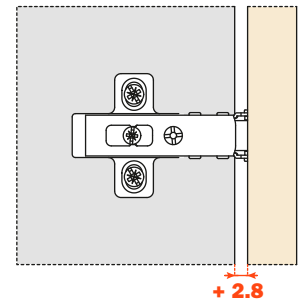
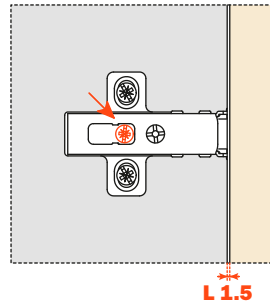
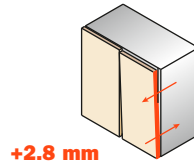

Traditional depth adjustment with Series 800 hinges

The hinge fixing screw is slackened and an oval slot on the arm of the hinge enables the door to be adjusted frontally from -1.5 mm to +3 mm. Finally the fixing screw must be retightened.

Réglage frontal traditionnel Série 800

Il est possible d'effectuer un réglage frontal de la porte de -1.5 mm à +3 mm. Le trou ovale permet le glissement de la charnière. Une fois l'opération terminée, la vis doit être resserrée.

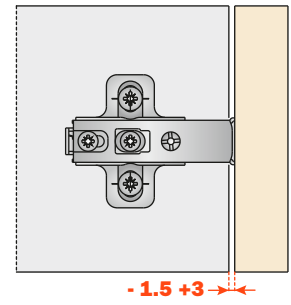
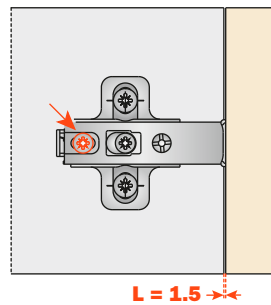
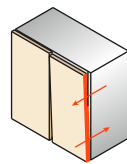

Depth adjustment with DOMI® snap-on mounting plates model BARxR.

Frontal adjustment is made without loosening any screws. The door can be moved frontally from -0.5 to +2.8 mm simply by rotating the cam adjuster in this series of mounting plates.

Réglage frontal avec embases Domi, modèle BARxR.

Il est possible d'effectuer un réglage frontal de la porte de -0.5 mm à +2.8 mm par une vis excentrique, sans avoir à dévisser une seule vis.

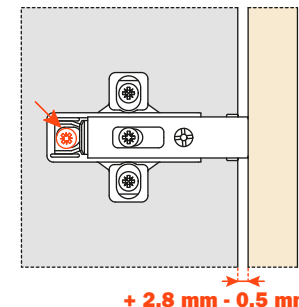
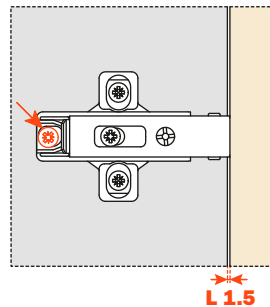
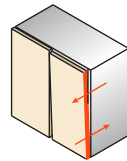

+2.8 mm
- 0.5 mm

Depth adjustment by cam • Réglage frontal par vis excentrique

Depth adjustment with DOMI® snap-on mounting plates model BAPxR.

Frontal adjustment is made without loosening any screws. The door can be moved frontally from -0.5 to +2.8 mm simply by rotating the cam adjuster in this series of mounting plates.

Réglage frontal avec embases Domi - modèle BAPxR

Il est possible d'effectuer un réglage frontal de la porte de -0.5 mm à +2.8 mm par une vis excentrique, sans avoir à dévisser une seule vis.

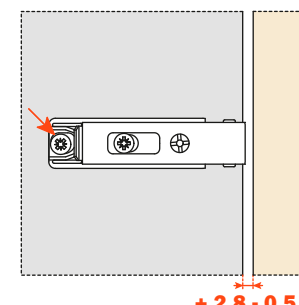
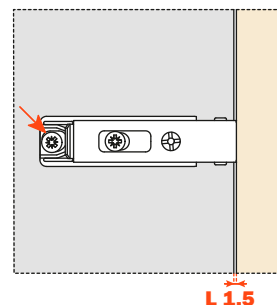
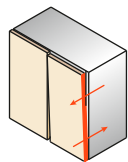

Side adjustments • Please use #2 Pozidrive screwdriver for all screws

Réglage latéral • Utiliser le tournevis POZIDRIVE n° 2 pour toutes les vis

Side to side adjustment of the door with 100, 200, F and Universal hinges.

Réglage latéral de la porte avec charnières Série 100, 200, F et charnières universelles.

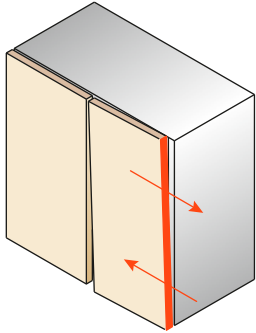

An ingenious adjustment system allows the door to be moved laterally without changing the gap behind the door (the "L" value of 1.5 mm remains constant).

Compensating side adjustment. A patented system exclusive to all Salice 100, 200, F and universal hinges.

Une technique spéciale de réglage latéral permet un déplacement de la porte en maintenant la même valeur "L" de 1.5 mm.

Réglage latéral compensé. C'est une exclusivité sur toutes les charnières Salice Série 100, 200, F et charnières universelles

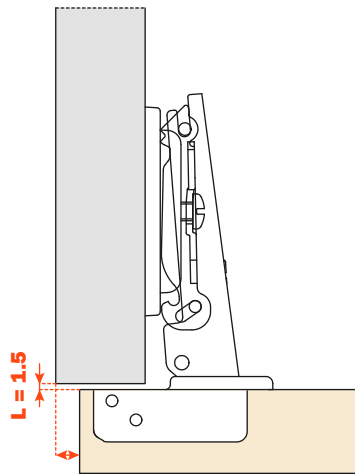
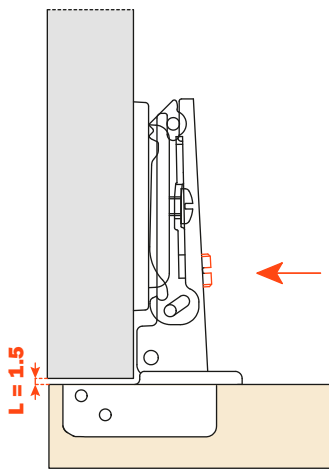

**-1.5 +4.5 mm (100, 200, and universal hinges/ série 100, 200 et charnières universelles)
-0.5 +5.5 mm (F series/ série F)**

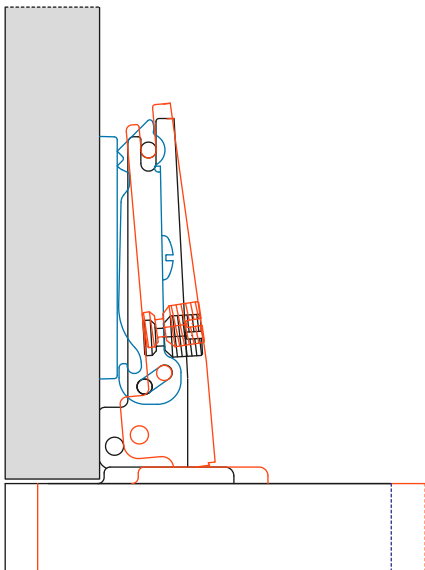

The adjustment screw operates in conjunction with the inner leaf of the hinge arm. The door moves in only one direction - parallel to the carcass and without a gap developing between the door and the carcass. No further adjustments are necessary. There is no gap to reduce.

Sideways adjustment of the door with Series 800 hinges.

Sideways adjustment of the door is made by using the indicated screw. It is possible to recover the gap behind the door by simply using the assembly stop located on the underside of the hinge.

La vis de réglage agit en faisant avancer le bras de la charnière.

La porte se déplace par rapport au côté en évitant tout détachement.

Des opérations d'ajustage, par la suite, ne sont plus nécessaires.

Réglage latéral de la porte avec charnières Série 800.

Régler latéralement la porte en agissant sur la vis indiquée. En utilisant la butée de montage présente sur le bras de la charnière, il est possible de conserver, lors de ce réglage.

Assembly instructions • 100, 200, F and universal hinges series Instructions de montage • Série 100, 200, F et charnières universelles

Assembly with 200 series traditional mounting plates.
Montage traditionnel avec embases Série 200.

Assembly with DOMI® snap-on mounting plates.
Montage avec embases Domi à fixation rapide.

- 1** Place the hinge onto the mounting plate.
Push the hinge up to the pre-determined stop under the hinge arm.

*Poser la charnière sur l'embase.
Positionnement avec butée en fin de course.*

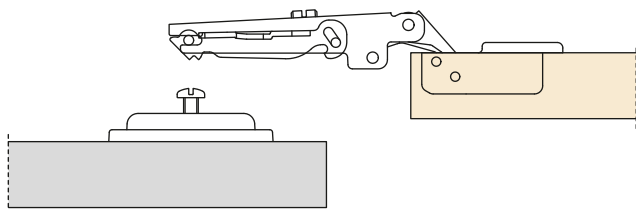

- 1** Locate the lugs on the mounting plate into the "J" hooks beneath the arm.

Mettre en contact les deux points comme indiqué par la flèche.

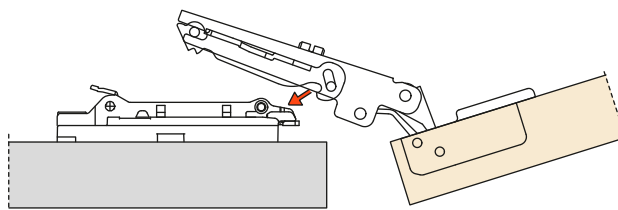

- 2** Tighten the fixing screw.
Serrer la vis de fixation.

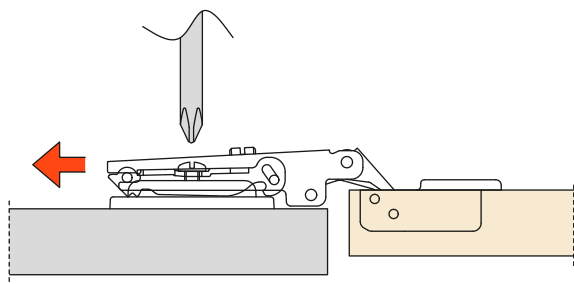

- 2** Gently rotate the hinge arm in the direction shown.
Marquer une légère rotation.

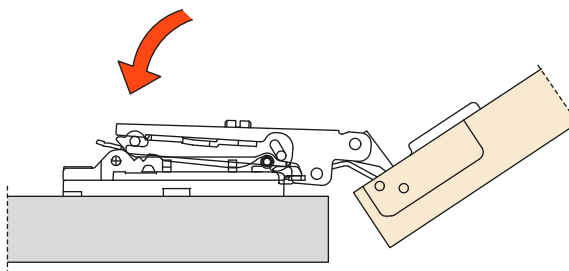

- 3** An «L» value of 1.5 mm between door and cabinet side is achieved on final assembly.

Après montage de la porte subsiste un valeur "L" de 1.5 mm.

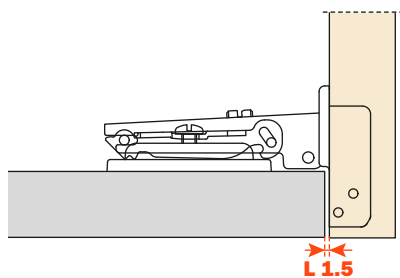

- 3** Then press lightly on the end of the arm to engage the catch.

Ensuite presser légèrement.

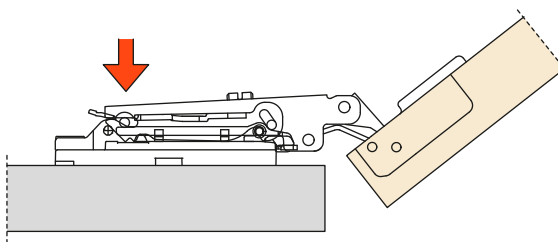

- 4** "Key hole" safety feature.
Dispositif de sécurité.

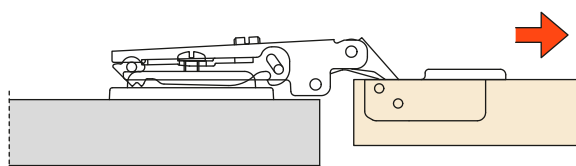

- 4** To remove the hinge from the mounting plate, press gently in the places shown by the arrows.

Pour décrocher la charnière de l'embase, exercer une pression sur les points indiqués.

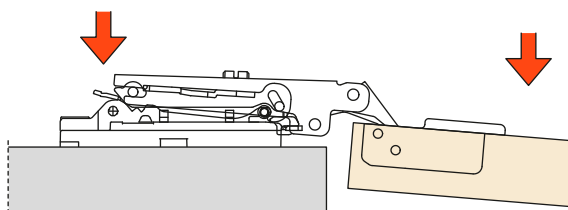





Hinges • Charnières

100 series • Hinges for thin doors (1/2") or doors with deep profiles - 105°

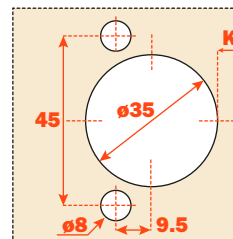

Série 100 • Charnières pour portes d'épaisseur réduite (1/2") ou portes avec profils profonds - 105°

	105° ø35	Packaging Emballage
		



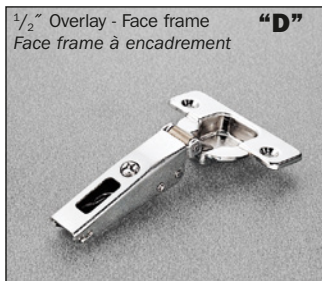
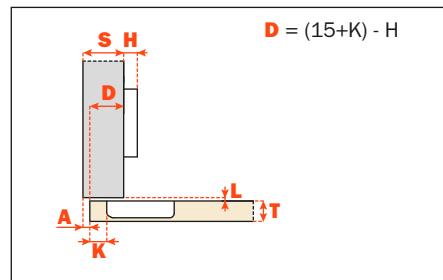

S/C		C1P6A99	300
S/C		C1R6A99	300



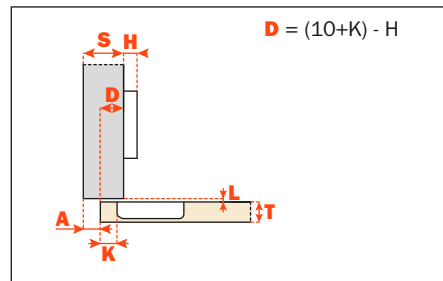

S/C		C1P6D99	300
S/C		C1R6D99	300



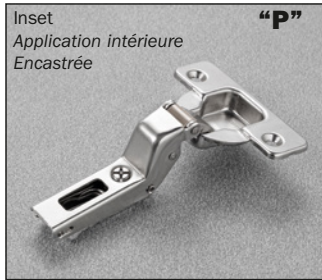
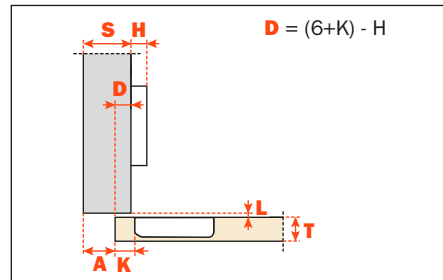

S/C		C1P6G99	300
S/C		C1R6G99	300



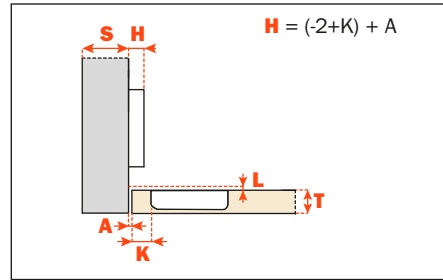





S/C		C1P6P99	300
S/C		C1R6P99	300







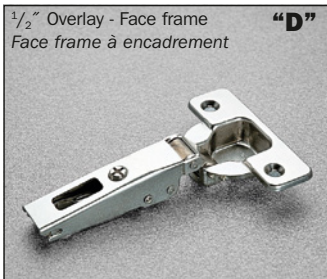

200 series • For kitchen cabinets and furniture
Série 200 • Pour meubles de cuisine et armoires

	110° ø35	120° ø35	Packaging Emballage
			









F/S		C2P4A99	C2P8A99	300
F/S		C2R4A99	C2R8A99	300
S/C		C2P6A99	C2P9A99	300
S/C		C2R6A99	C2R9A99	300
S/C		C276A99	C279A99	300
S/C		C2J6A99	C2J9A99	300









F/S		C2P4D99	C2P8D99	300
F/S		C2R4D99	C2R8D99	300
S/C		C2P6D99	C2P9D99	300
S/C		C2R6D99	C2R9D99	300
S/C		C276D99	C279D99	300
S/C		C2J6D99	C2J9D99	300



F/S		C2P4G99	C2P8G99	300
F/S		C2R4G99	C2R8G99	300
S/C		C2P6G99	C2P9G99	300
S/C		C2R6G99	C2R9G99	300
S/C		C276G99	C279G99	300
S/C		C2J6G99	C2J9G99	300



F/S		C2P4P99		300
F/S		C2R4P99		300
S/C		C2P6P99		300
S/C		C2R6P99		300
S/C		C276P99		300
S/C		C2J6P99		300

Legend - Notes explicatives:



Screw-in
A visser



Press-in
Tourillon à
pression



Rapido
Rapido



Logica
Logica

F/S = Free Swinging - Sans ressort
S/C = Self-closing - Avec ressort

200 Series • For kitchen cabinets and furniture Série 200 • Pour meubles de cuisine et armoires

	165° ø35	Packaging Emballage
		



F/S		C2PEA99	100
F/S		C2REA99	100
S/C		C2PFA99	100
S/C		C2RFA99	100
S/C		C27FA99	100
S/C		C2JFA99	100



F/S		C2PED99	100
F/S		C2RED99	100
S/C		C2PFD99	100
S/C		C2RFD99	100
S/C		C27FD99	100
S/C		C2JFD99	100



F/S		C2PEG99	100
F/S		C2REG99	100
S/C		C2PFG99	100
S/C		C2RFG99	100
S/C		C27FG99	100
S/C		C2JFG99	100

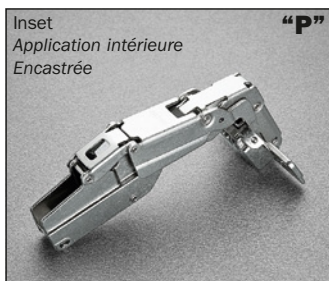

F/S		C2PEP99	100
F/S		C2REP99	100
S/C		C2PFP99	100
S/C		C2RFP99	100
S/C		C27FP99	100
S/C		C2JFP99	100

3/8" lip door application Inset hinge - crank "P"

3/8" application avec portes moulurées Charnière application encastrée - bras "P"

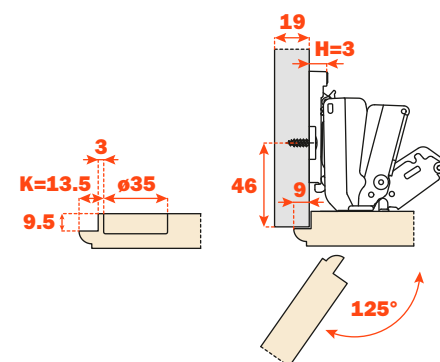

Greater drilling distance can be used to achieve large overlays with the use of reduction clips (see pag. 59).

Une plus grande distance de perçage peut être utilisée pour réaliser des recouvrements plus importantes avec l'utilisation de arrêts (voir page 59).

To limit hinge opening, please request the appropriate stops.

For a 125° reduction use item no. S2AF37X3

For a 110° reduction use item no. S2BF37XY.

Pour limiter l'ouverture de la charnière, veuillez demander les arrêts appropriés.

Pour limiter à 125° utiliser le code S2AF37X3.

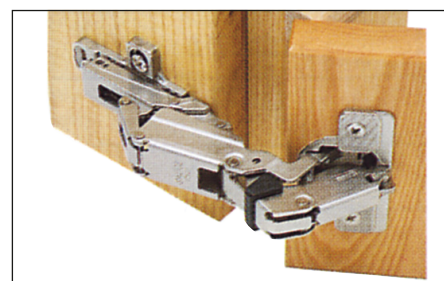

Pour limiter à 110° utiliser le code S2BF37XY.



200 series • For thicker doors - 155° • Special H Series, wide angle for the thickest door - up to a maximum of 35 mm
Série 200 • Pour portes épaisses - 155° • Série spéciale H, grand angle pour la porte la plus épaisse
• jusqu'à un maximum de 35 mm

S/C = Self-closing
 S/C = Avec ressort



		155° Ø35	Packaging Emballage
			
S/C		C2PHA99	100
S/C		C2RHA99	100

155° • Special applications • Applications spéciales

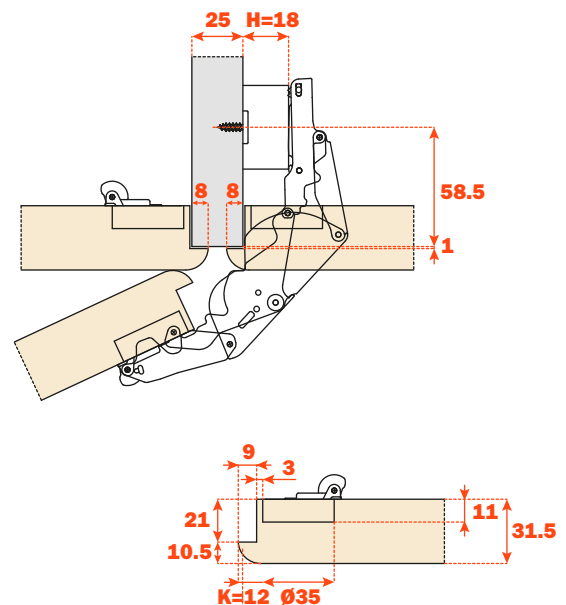
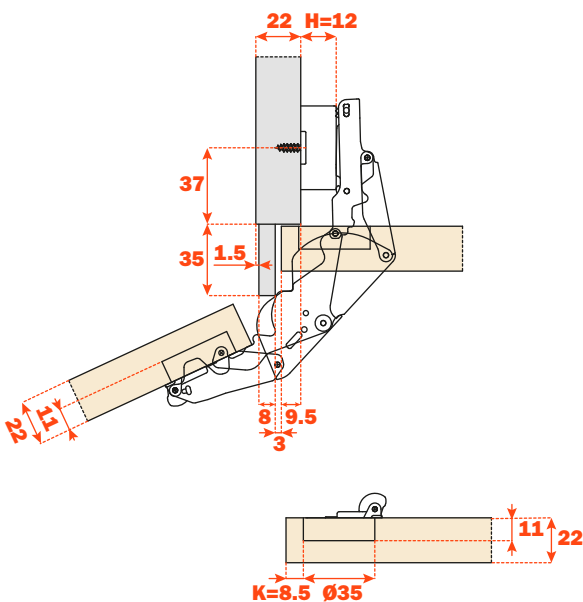
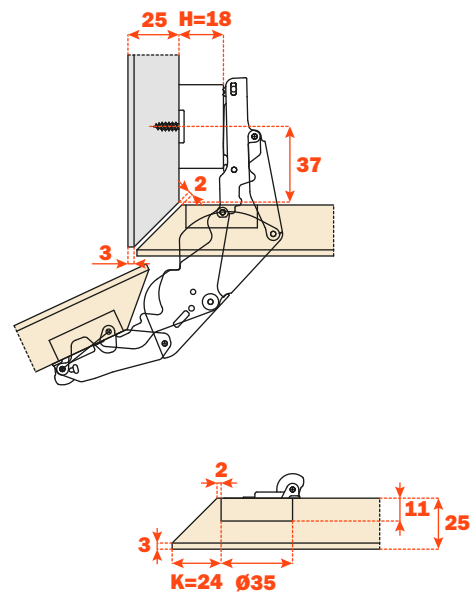
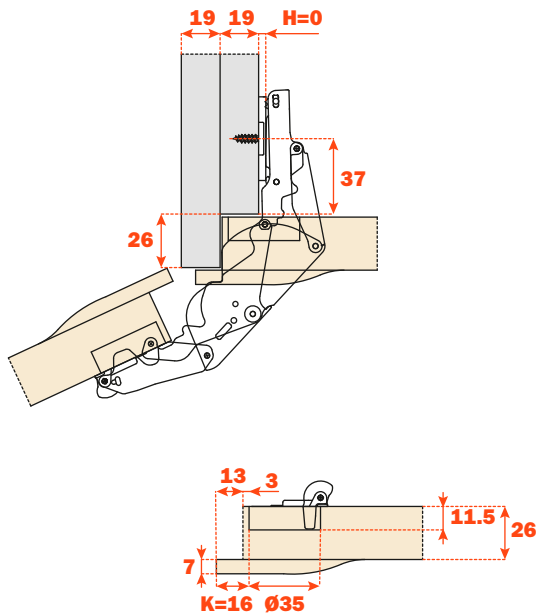

200 series • For thicker doors - 155° • Special H Series, wide angle for the thickest door
Série 200 • Pour portes épaisses - 155° • Série spéciale H, grand angle pour la porte la plus épaisse

155° • Thick door applications • Applications portes épaisses

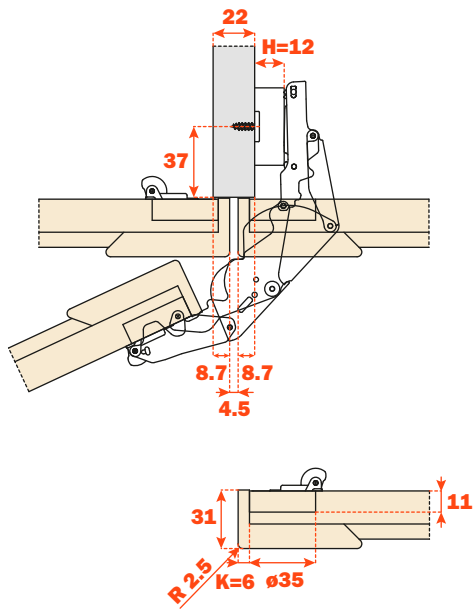

Zero protrusion 90° • Thick door applications
 Sans recul de la porte à 90° • Applications portes épaisses

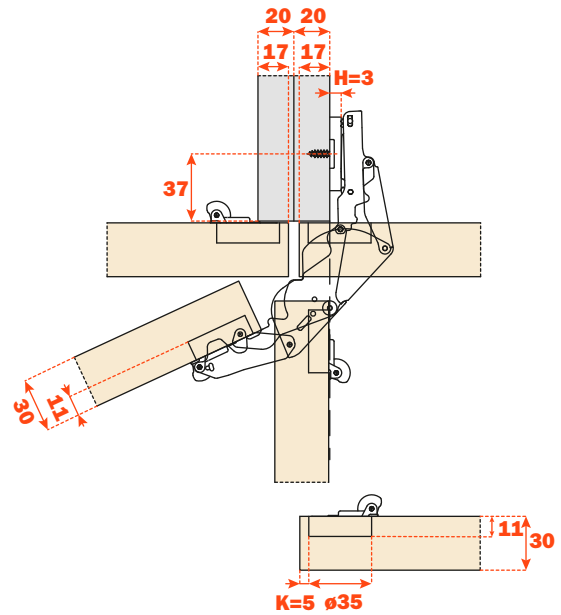



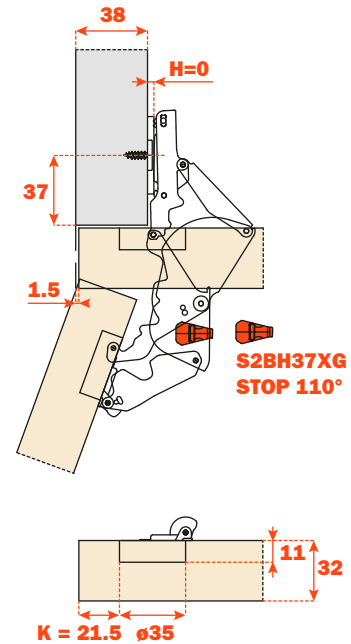
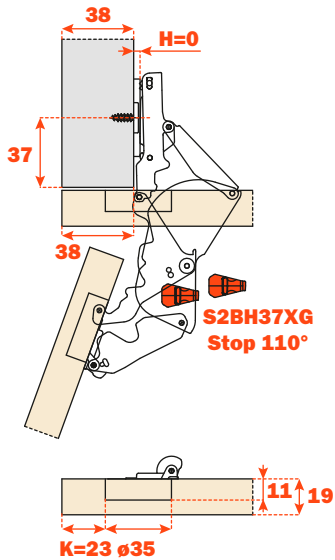

Thick panel overlay • with opening reduction device
 Recouvrement côtés épaisses • avec arrêts pour limiter l'ouverture

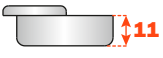





200 series • Special hinges for kitchen cabinets and furniture - positive angle hinges
Série 200 • Charnières spéciales pour meubles de cuisine et armoires - angle positif

	94° ø35	Packaging Emballage
		

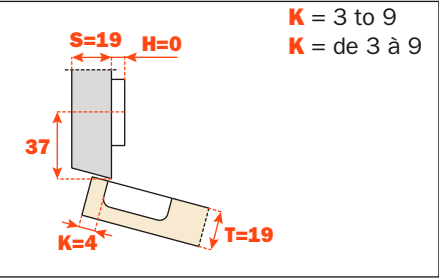





S/C		C2PBZ99	150
S/C		C2RBZ99	150
S/C		C27BZ99	150
S/C		C2JBZ99	150

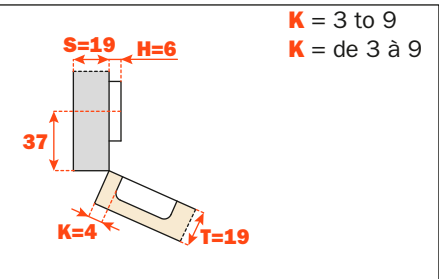





S/C		C2PBU99	150
S/C		C2RBU99	150
S/C		C27BU99	150
S/C		C2JBU99	150

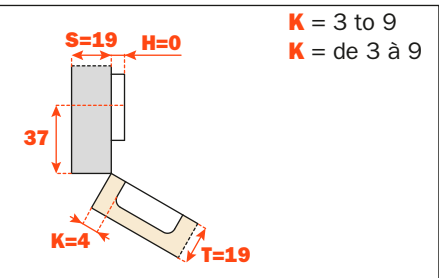





S/C		C2PBE99	150
S/C		C2RBE99	150
S/C		C27BE99	150
S/C		C2JBE99	150

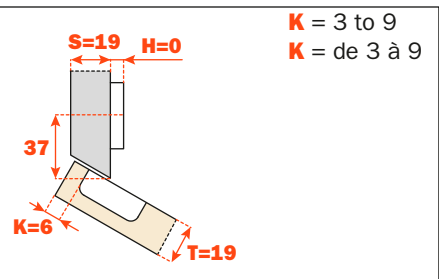

S/C		C2PBT99	150
S/C		C2RBT99	150
S/C		C27BT99	150
S/C		C2JBT99	150



S/C		C2PBK99	150
S/C		C2RBK99	150
S/C		C27BK99	150
S/C		C2JBK99	150

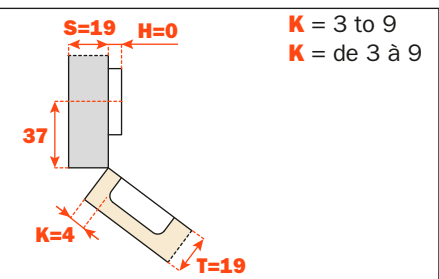

200 Series • Special hinges for kitchen cabinets and furniture - positive angle hinges Série 200 • Charnières spéciales pour meubles de cuisine et armoires - angle positif

	94° ø35	Packaging Emballage
		



S/C		C2PBM99AC	150
S/C		C2RBM99AC	150
S/C		C27BM99AC	150
S/C		C2JBM99AC	150

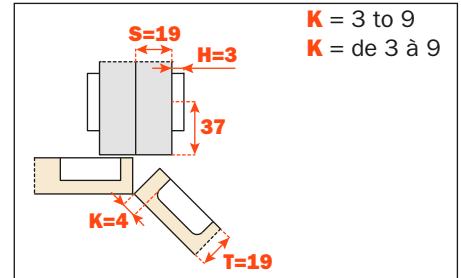

S/C		C2PBM99	150
S/C		C2RBM99	150
S/C		C27BM99	150
S/C		C2JBM99	150

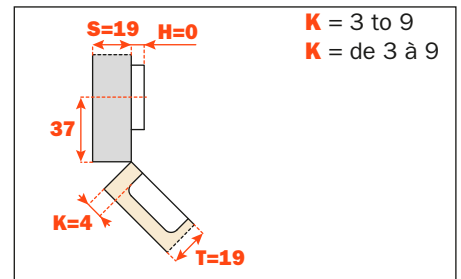

S/C		C2PBV99	150
S/C		C2RBV99	150
S/C		C27BV99	150
S/C		C2JBV99	150

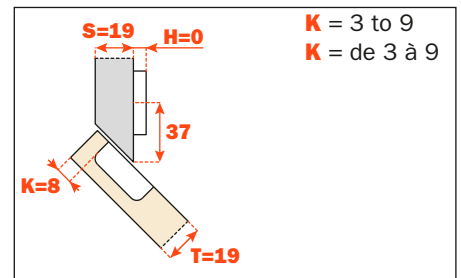

S/C		C2PYA99	150
S/C		C2RYA99	150
S/C		C27YA99	150

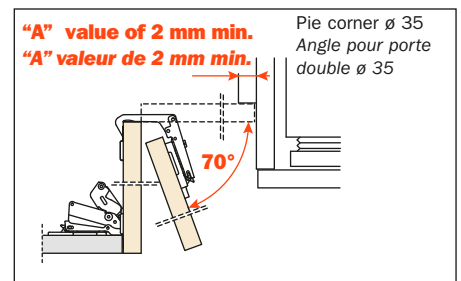

Pie Corner hinge installation: Selecting & positioning the mounting plate Installation de la charnière d'angle pour porte double: Sélection et positionnement de l'embase			
If Door thickness is: Si l'épaisseur de la porte est : (T)	Use mounting plate height Utiliser l'embase avec hauteur (H)	Mounting plate location Door edge to screw center Distance de perçage pour embase cruciforme (B)	Hinge cup edge bore distance Distance de perçage (K)
16 mm (5/8")	6 mm	31 mm (1-1/4")	4 mm
19 mm (3/4")	2 mm or 3 mm	28 mm (1-1/8")	4 mm
22 mm (7/8")	0 mm	25 mm (1")	4mm



165° hinges
165° charnière
Pie cut hinges
Charnières d'angle pour porte double

Mounting plate
Embase

200 series • Special hinges for kitchen cabinets and furniture - negative angle hinges
Série 200 • Charnières spéciales pour meubles de cuisine et armoires - angle négatif

	94° ø 35	Packaging Emballage
		



S/C		C2PBW99	150
S/C		C2RBW99	150
S/C		C27BW99	150
S/C		C2JBW99	150

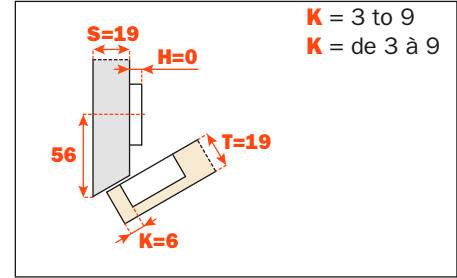

S/C		C2PBH99	150
S/C		C2RBH99	150
S/C		C27BH99	150
S/C		C2JBH99	150

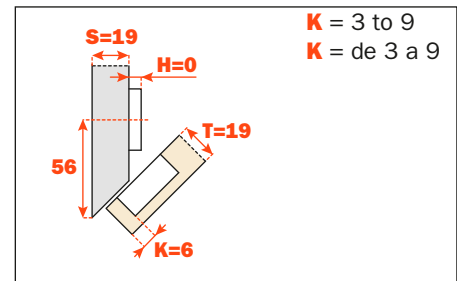

Custom CAD drawings are available for cabinet designs which feature special angles, curves and other unique design elements.
 Les dessins CAD personnalisés sont disponibles pour les projets de meubles avec angles spéciaux, courbes et autres éléments de conception uniques.

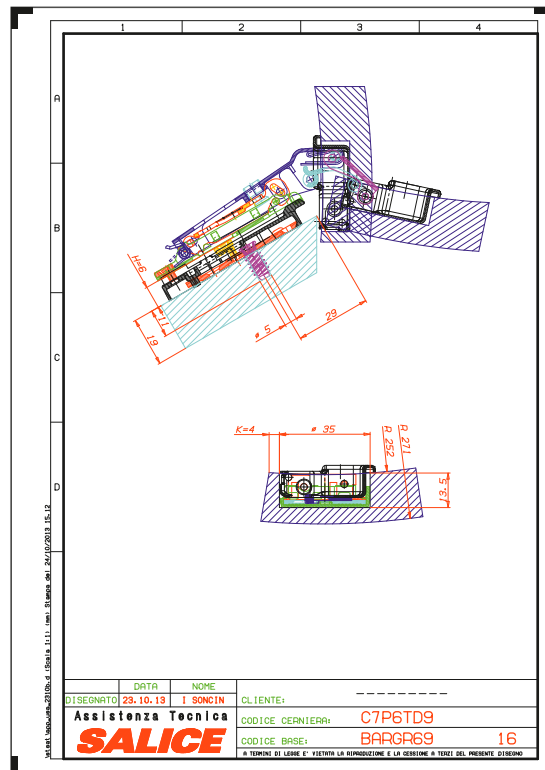
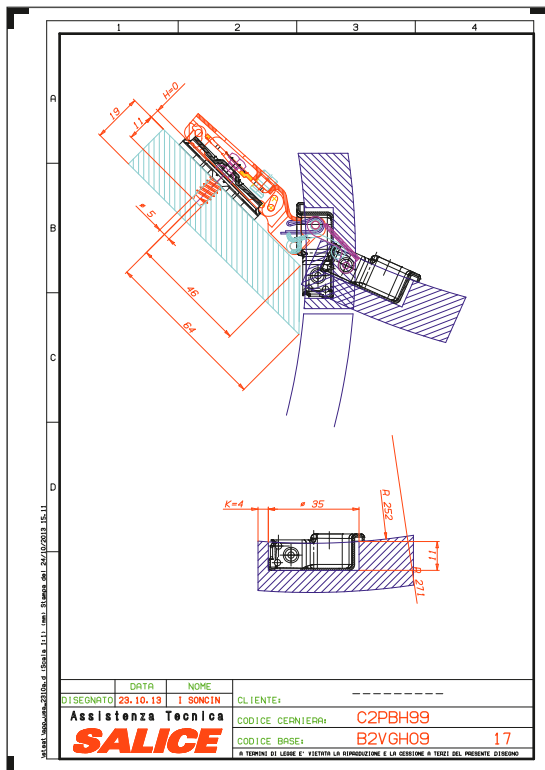



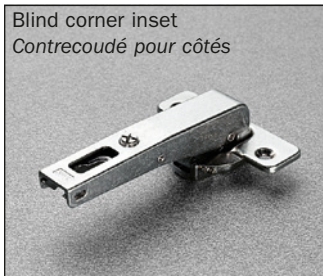

200 Series • Special hinges for kitchen cabinets and furniture - blind corner hinges Série 200 • Charnières spéciales pour meubles de cuisine et armoires - contrecodé pour côtés

	94° ø35	Packaging Emballage
		

Blind corner ø 35
Mounting plate: H = 2 or 3
Contrecodé pour côtés ø 35
Embase : H = 2 ou 3



S/C		C2PBN99AC	150
S/C		C2RBN99AC	150
S/C		C27BN99AC	150
S/C		C2JBN99AC	150

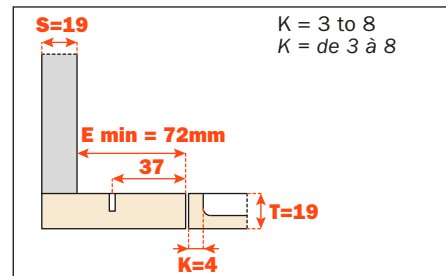

Heights of mounting plates for every assembly. Hauteurs des embases pour chaque montage.

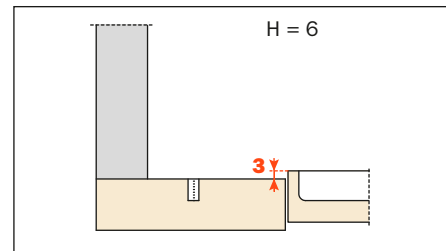
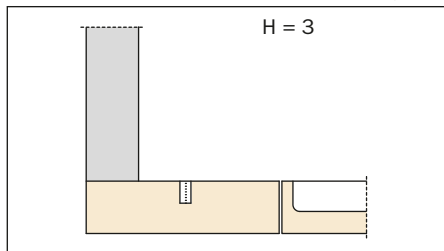
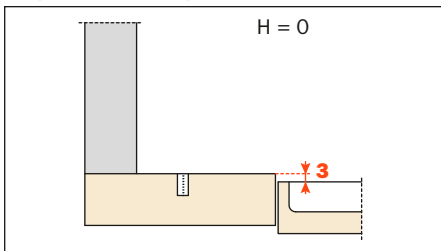



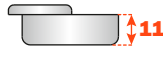

IMPORTANT: If door and panel are the same thickness ($\frac{3}{4}$ " S with $\frac{3}{4}$ " T or $\frac{5}{8}$ " S with $\frac{5}{8}$ " T) the mounting plate choices remain the same.
IMPORTANT: si la porte et le côté ont la même épaisseur ($\frac{3}{4}$ " S avec $\frac{3}{4}$ " T ou $\frac{5}{8}$ " S avec $\frac{5}{8}$ " T), les choix de l'embase restent les mêmes.

	110° ø35	Packaging Emballage
		

Blind corner overlay ø 35
Mounting plate: H = 2 or 3
Contrecodé long ø 35
Embase: H = 2 ou 3



S/C		C2P6N99AM	150
S/C		C2R6N99AM	150
S/C		C276N99AM	150
S/C		C2J6N99AM	150

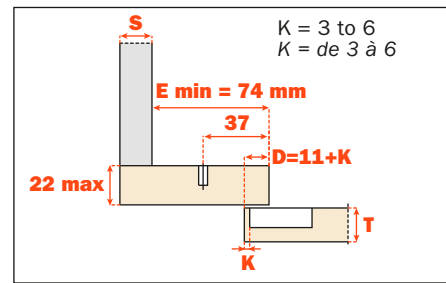

Mounting plate heights for every assembly. Hauteurs des embases pour chaque montage.

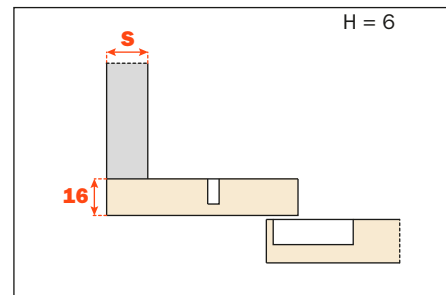
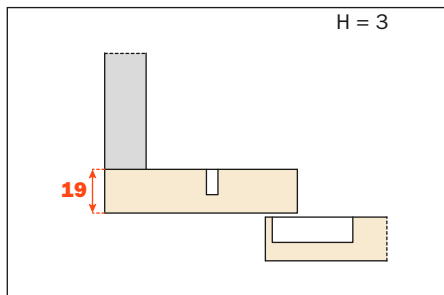
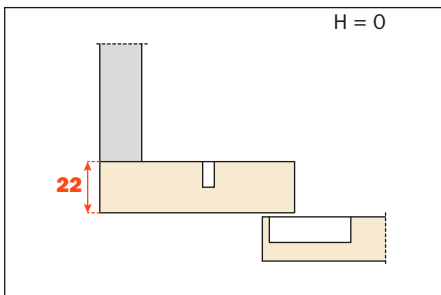

200 series • Special hinges for kitchen cabinets and furniture - blind corner hinges
Série 200 • Charnières spéciales pour meubles de cuisine et armoires - contrecoudé pour côtés

	94° ø35	Packaging Emballage
		

Blind corner ø 35
 Compatible with all traditional
 Series 200 mounting plates,
 28x32 mm drilling.

NOT COMPATIBLE with Domi
 snap-on mounting plates.





Contrecoudé ø 35
 Adaptables à toutes les
 embases traditionnelles Série
 200, perçage 28x32 mm.

NON ADAPTABLES aux
 embases Domi à fixation
 rapide.



B2S3B99B6/15



S/C		C2PBN99	150
S/C		C2RBN99	150
S/C		C27BN99	150
S/C		C2JBN99	150

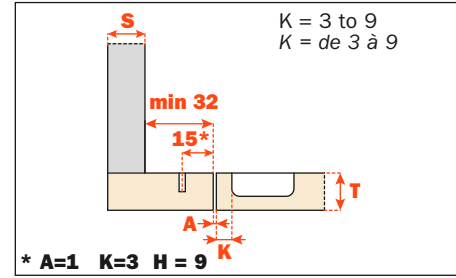



200 Series • For thicker doors - 94° Série 200 • Pour portes épaisses - 94°

S/C = Self-closing
S/C = Avec ressort

F/S = Free swing
F/S = Sans ressort

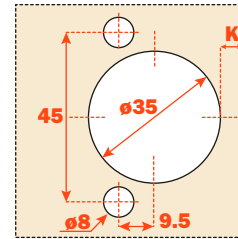
	94° ø35	Packaging Embalaje
		



 <p>Full overlay Plein recouvrement Porte en applique</p> <p>"A"</p>	F/S		C2PAA99	300
	F/S		C2RAA99	300
	S/C		C2PBA99	300
	S/C		C2RBA99	300
	S/C		C27BA99	300
	S/C		C2JBA99	300

For thick doors up to 32 mm (1- 1/4") 11 mm deep metal cup, possible drilling distance on the door (K); from 3 to 9 mm

For full overlay doors up to 1- 1/4" thick, choose one of the following solutions, K=8

Arm "A" + 6 mm plate + adjustment
- or -
Arm "D" + 0 mm plate + adjustment

 <p>1/2" Overlay - Face frame Face frame à encadrement</p> <p>"D"</p>	S/C		C2PBD99	300
	S/C		C2RBD99	300

Pour les portes d'épaisseur jusqu'à 32 mm (1- 1/4"), profondeur du boîtier métallique 11 mm. Possibilité de perçage de la porte (K) de 3 à 9 mm.

Pour les portes en applique jusqu'à 1- 1/4" d'épaisseur, choisir une des options suivantes, K=8

Bras "A" + embase 6 mm + réglage
- ou -
Bras "D" + embase 0 mm + réglage

 <p>Half overlay Demi recouvrement Portes jumelées</p> <p>"G"</p>	F/S		C2PAG99	300
	F/S		C2RAG99	300
	S/C		C2PBG99	300
	S/C		C2RBG99	300
	S/C		C27BG99	300
	S/C		C2JBG99	300

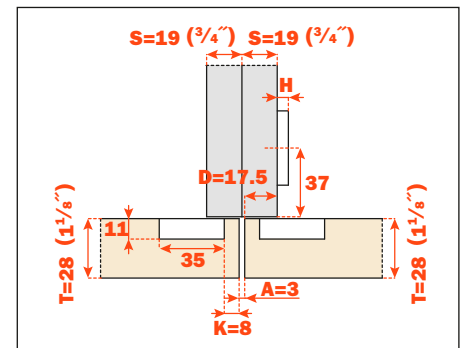

For inset doors:
Arm "P" + 9 mm plate + adjustment Up to 1- 1/4" thick. K=8

Pour portes avec application intérieure/ encastrée :
Bras "P" + embase 9 mm + réglage jusqu'à 1- 1/4" d'épaisseur K=8

 <p>Inset Application intérieure Encastrée</p> <p>"P"</p>	F/S		C2PAP99	300
	F/S		C2RAP99	300
	S/C		C2PBP99	300
	S/C		C2RBP99	300
	S/C		C27BP99	300
	S/C		C2JBP99	300

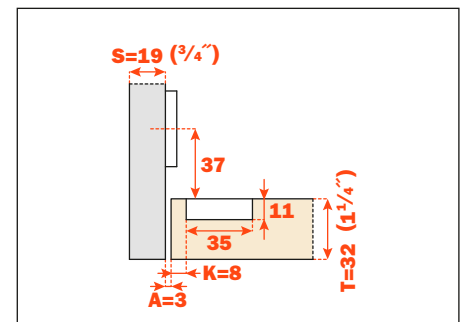

S2A637XF 86° Reduction clip.

The reduction in the opening prevents the collision of doors against walls and other obstacles. (see pag 59)

S2A637XF Arrêt à 86°.



La limitation de l'ouverture évite toutes les interférences des portes contre les murs et autres obstacles (voir page 59).

200 series • For thicker doors - 155° • K Series, zero protrusion, wide angle
Série 200 • - Pour portes épaisses - 155° • Série K, sans recul de la porte, grand angle

S/C = Self-closing
 S/C = Avec ressort

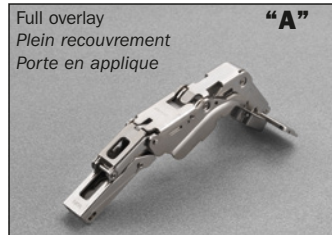
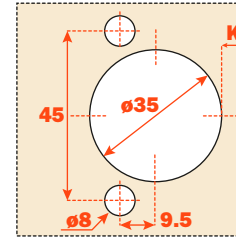
	155° ø35	Packaging Emballage
		





S/C		C2PKA99	100
S/C		C2RKA99	100

For pull out shelf application, total door clearance (zero protrusion) begins at 90° opening.
 Full overlay (19 mm - 3/4") application only. 0 mm to 6 mm plates only.

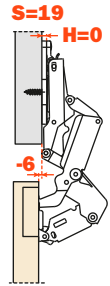
Pour des espaces avec éléments extractibles.
 Avec une ouverture à 90° et une embases H=0, la porte dégage de 6 mm.





S/C		C2PKD99	100
S/C		C2RKD99	100

For thick doors up to 28 mm (1-1/8") 11 mm deep metal cup, possible drilling distance on the door (K); from 3 to 9 mm

For full overlay doors up to 1-1/8" thick, choose one of the following solutions, K=8

Arm "A" + 6 mm plate + adjustment
 - or -
 Arm "D" + 0 mm plate + adjustment



S/C		C2PKG99	100
S/C		C2RKG99	100

Pour les portes d'épaisseur jusqu'à 28 mm (1-1/8"), profondeur du boîtier métallique 11 mm. Possibilité de perçage de la porte (K) de 3 à 9 mm.

Pour les portes en applique jusqu'à 1-1/8" d'épaisseur, choisir une des options suivantes, K=8

Bras "A" + embase 6 mm + réglage
 - ou -
 Bras "D" + embase 0 mm + réglage

S2BF37XY 110° Reduction clip
S2AF37X3 125° Reduction clip

Reduction clip can be used to allow the increase of drilling distance and overlay. The reduction in the opening allows the turning of thicker doors. (see pag. 59)

S2BF37XY Arrêt à 110°
S2AF37X3 Arrêt à 125°

L'arrêt peut être utilisé pour augmenter la distance de perçage et le recouvrement. La limitation de l'ouverture permet la rotation de portes plus épaisses (voir page 59).

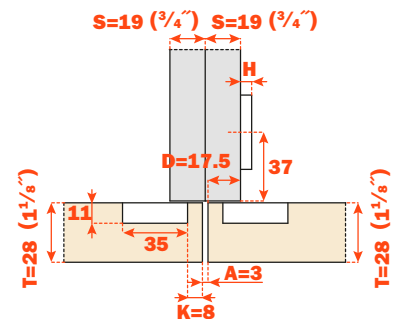



Series 300 • compact hinge for special applications Série 300 • charnière compacte pour applications spéciales

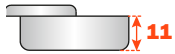

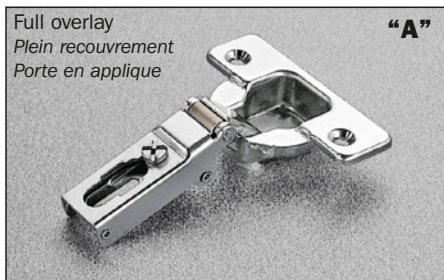
S/C = Self-closing
S/C = Avec ressort

	94° Ø35	Packaging Emballage
		

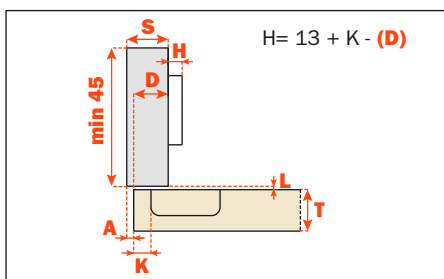
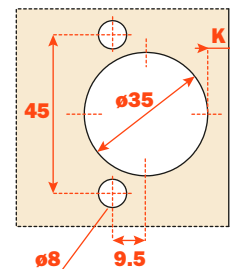

S/C		C3PBA99	300
S/C		C3RBA99	300



	<p>0mm Side panel 3/4" Full overlay</p> <p>Côté 3/4" Porte en applique</p> 	<p>6mm 1/2" overlay Partial overlay</p> <p>Côté 1/2" Face frame à encadrement</p> 	Packaging Emballage
--	---	---	------------------------

	Series 300 - mounting plates - drilling 20x32 Série 300 - embases - perçage 20x32			
Die-cast - Zamak		B383E09	B383E69	600

S38X8639



Spacers

3 mm spacer for special applications

Supports

Support pour l'embase hauteur 3 mm pour applications spéciales

Packaging - Emballage
300

S38X86D9



Spacers

13 mm spacer for special applications

Supports

Support pour l'embase hauteur 13 mm pour applications spéciales

Packaging - Emballage
300



Series 800 • An affordable clip system
Série 800 • Un système de clips abordable

S/C = Self-closing
S/C = Avec ressort



F/S = Free Swinging
F/S = Sans ressort

	110° Ø35	Packaging Emballage
		



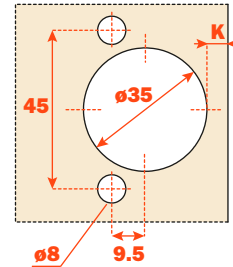

S/C		C8P6C99	300
S/C		C8R6C99	300
S/C		C876C99	300



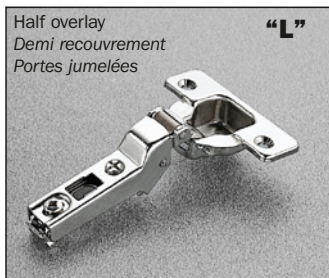

S/C		C8P6J99	300
S/C		C8R6J99	300
S/C		C876J99	300



S/C		C8P6L99	300
S/C		C8R6L99	300
S/C		C876L99	300



S/C		C8P6S99	300
S/C		C8R6S99	300
S/C		C876S99	300

To be assembled (clip) on B2VXH plates exclusively (I.E. B2V3H09/15)

Montage (automatique) exclusivement avec l'embase B2VXH
(EX. B2V3H09/15)

Universal hinges • Hinges with integrated silicone-oil damper for doors with special profiles
Charnières Universelles • Charnières avec amortisseur hydraulique intégré, pour portes moulurées

Cup depth 9 mm, opening 110° K = 3 to 18 mm (on square edge doors).

Profondeur du boîtier 9 mm, ouverture à 110°, K de 3 à 18 mm (pour portes carrées).

110° ø35		Packaging Emballage
		



CBP2AE9	with integrated soft-close • avec amortisseur intégré	150
CBP2AC9	sprung hinge • charnière avec ressort	150
CBPQAC9	with Push opening • avec ouverture Push	150
CBP1AC9	free swing hinge • charnière sans ressort	150

SBAX78A6SN



Hollow cover

Cache

SBXX85X_

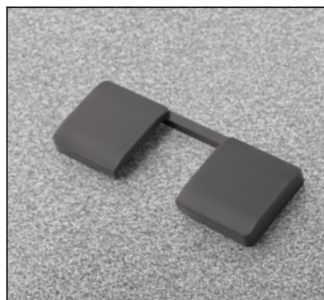

Flange cover cap

Plastic flange cover cap

Cache pour boîtier.
Cache-boîtier en nylon.

Available colors:
Couleurs disponibles:

SBXX85X9 = Nickel-plated
nickelé mat
SBXX85X6 = Titanium
Titane

DBDESNG



Smove, Soft-close device

Smove

SBA237XG

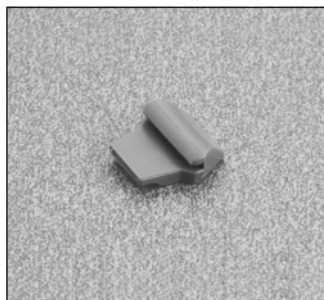

Stop device

It limits the opening angle to 90°

Arrêt

Pour limiter l'ouverture à 90°



Universal hinges • Disassembly and assembly instructions Charnières Universelles • Instructions de démontage et montage

Disassembly of the Smove.

It is possible to convert the hinges with integrated soft-close into sprung hinges by replacing the Smove with the hollow cover.

Démontage du Smove.

Possibilité de convertir les charnières avec amortisseur intégré en charnières avec ressort en remplaçant le Smove par le cache.

Lift the Smove using a flat-blade screwdriver.
Soulever le Smove avec un tournevis plat.

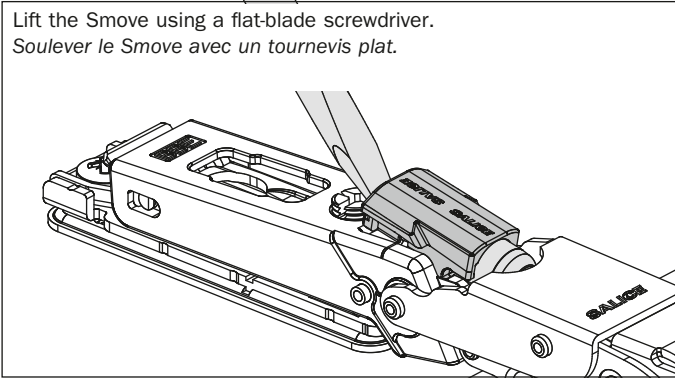

Remove the Smove from the hinge arm.
Enlever le Smove.

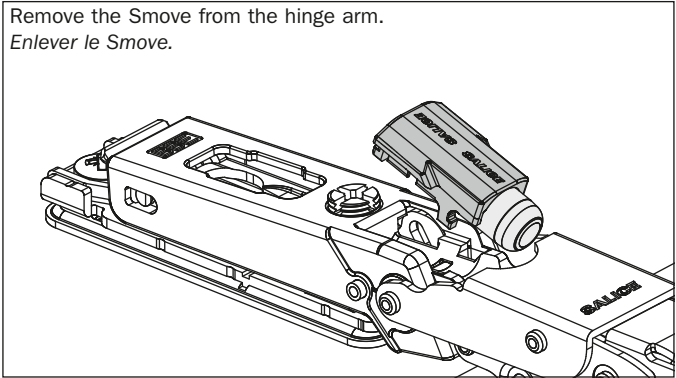

Insert the hollow cover frontally.
Insérer le cache frontalement.

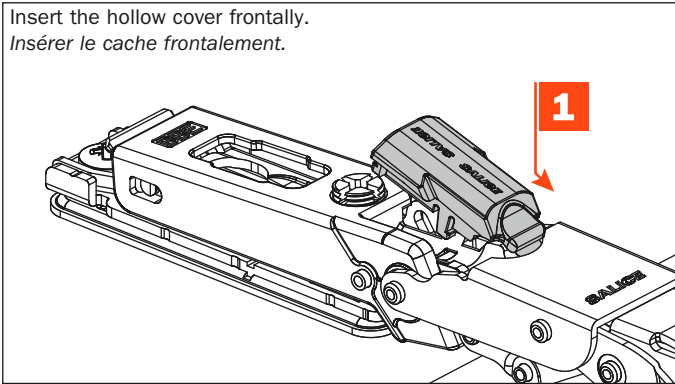

Press lightly on the back to fix in position.
Appuyer légèrement sur l'extrémité arrière.

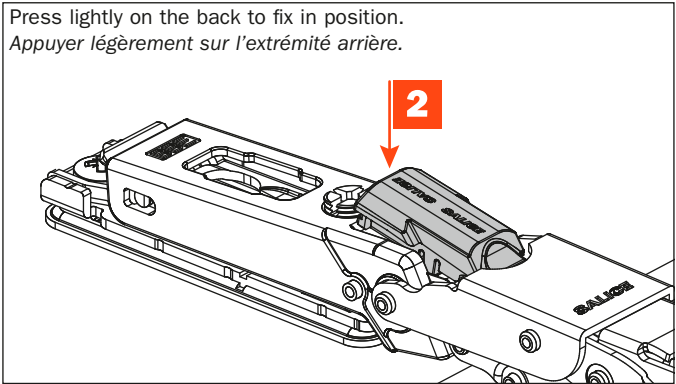

Disassembly of the hollow cover.

It is possible to convert the sprung hinges into hinges with integrated soft-close by replacing the hollow cover with the Smove.

Démontage du cache.

Possibilité de convertir les charnières avec ressort en charnières avec amortisseur intégré en remplaçant le cache par le Smove.

Lift the hollow cover using a flat-blade screwdriver.
Soulever le cache avec un tournevis plat.

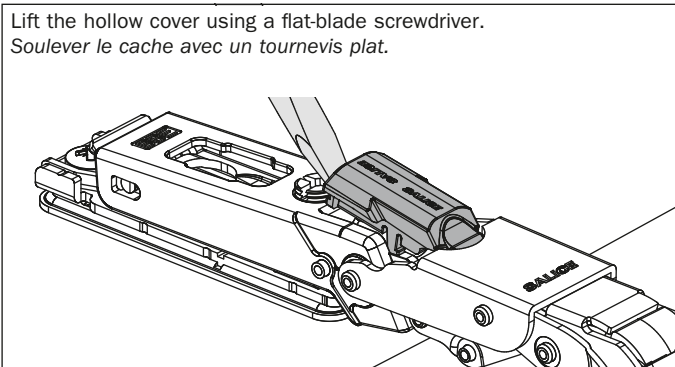

Remove the hollow cover.
Enlever le cache.

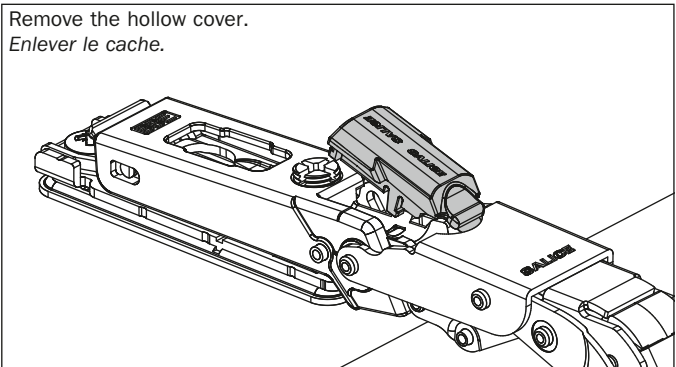

Insert the Smove frontally.
Insérer le Smove frontalement.

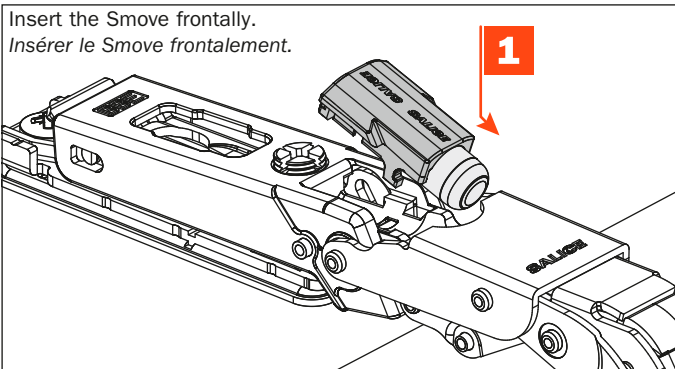

Press lightly on the back to fix in position.
Appuyer légèrement sur l'extrémité arrière.

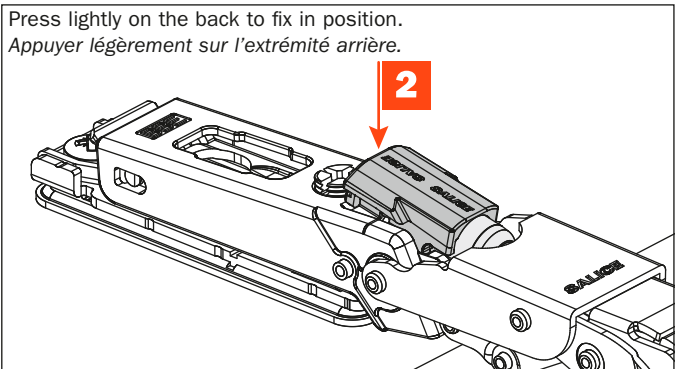

**Universal hinges
Charnières Universelles**

Abbreviations chart - Abréviations:

S = thickness of the cabinet side
épaisseur du côté

D = required door overlay
recouvrement désiré

T = max. door thickness
épaisseur max. de la porte

K = drilling distance
distance de perçage

A = reveal
jeu

L = gap between door and carcass
distance entre la porte et le côté

H = height of the mounting plate
hauteur de l'embase

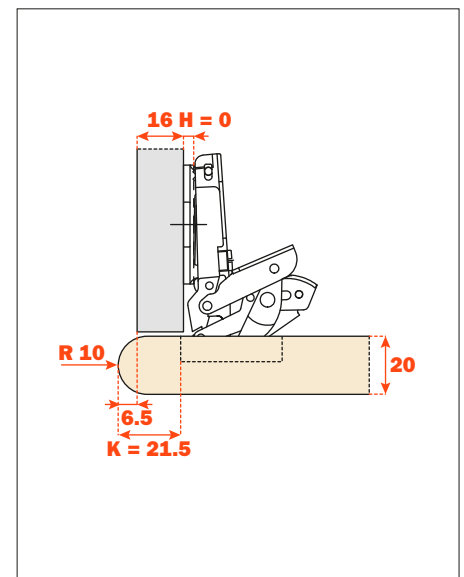
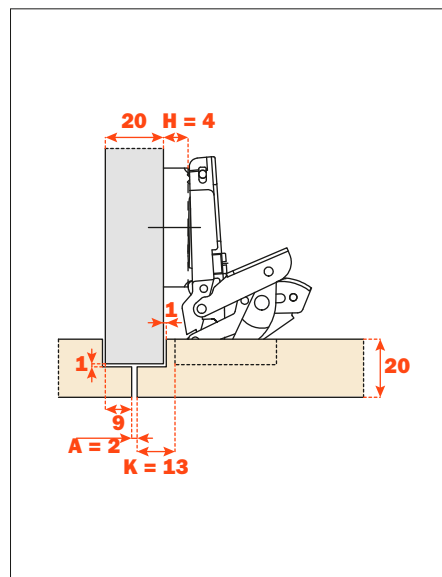
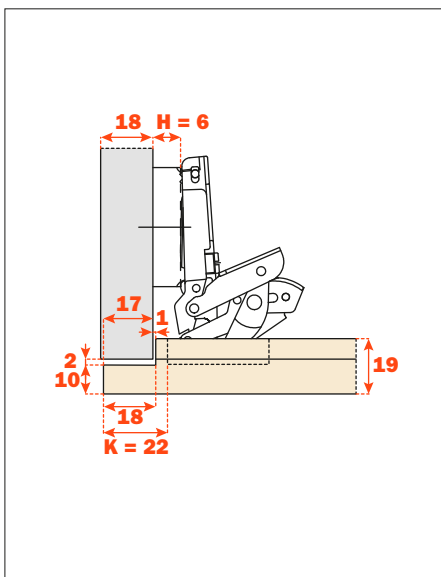
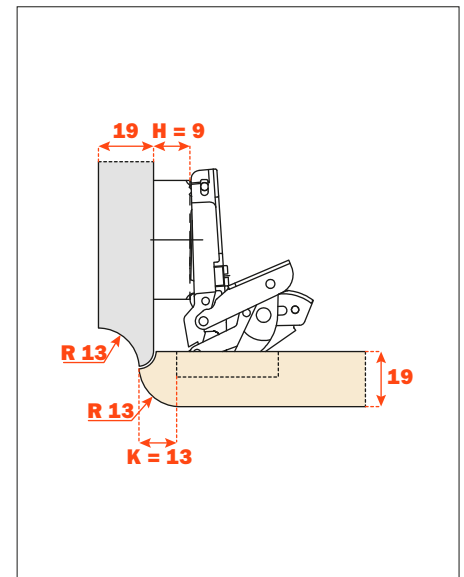
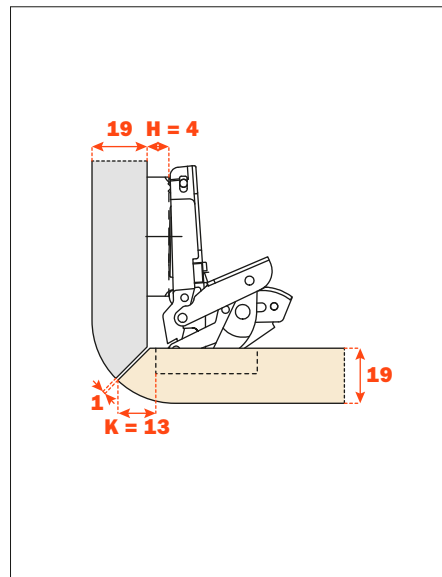
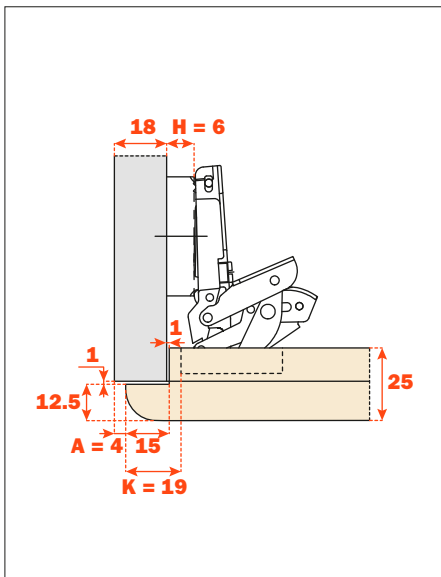
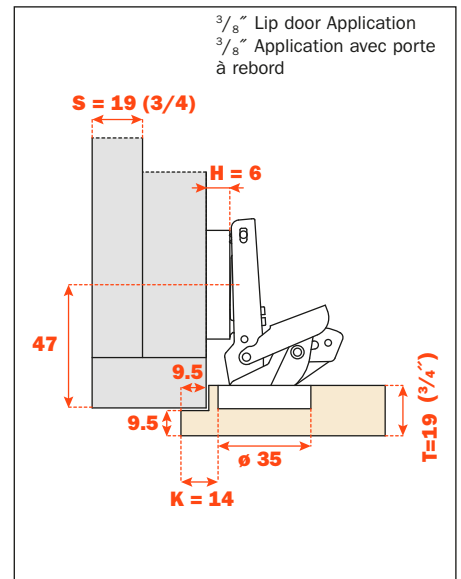

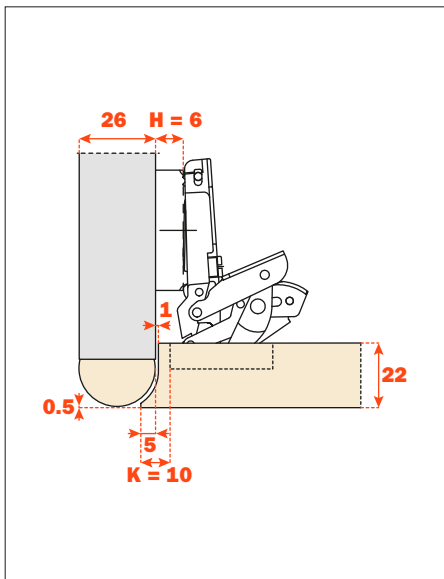
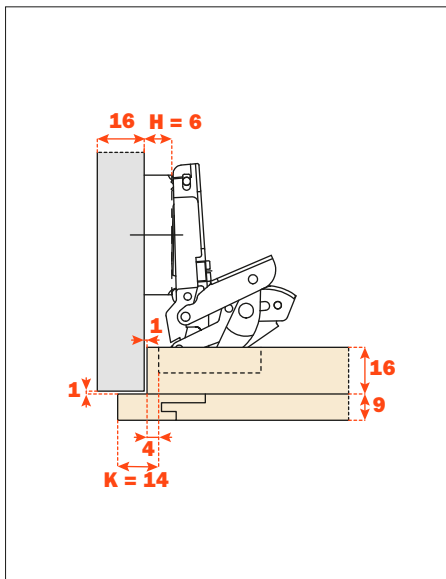
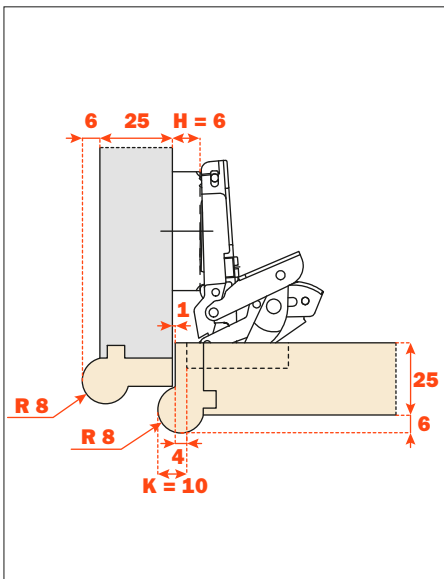
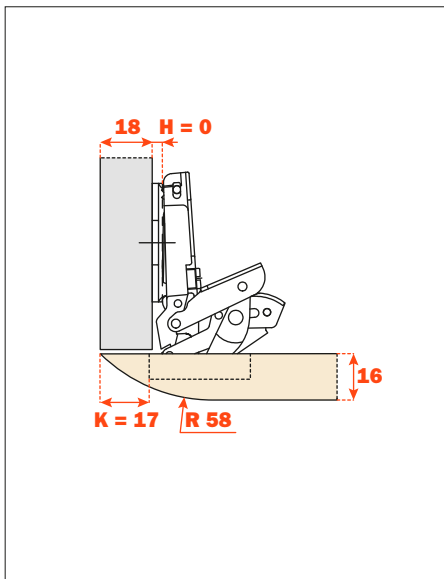
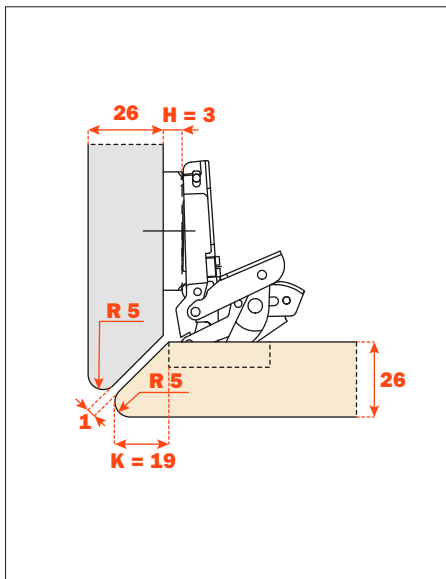
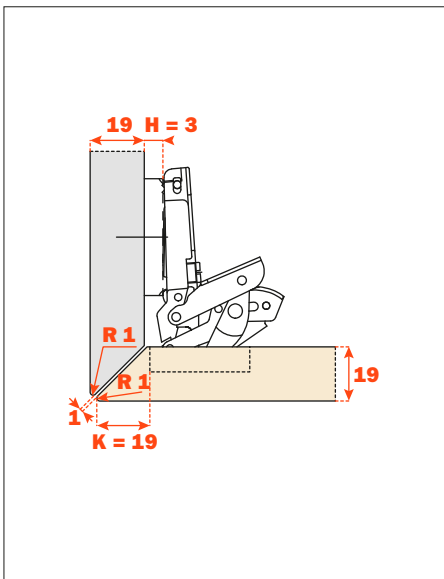

Single pivot hinge • 270° opening
Charnière à un axe • Ouverture à 270°

Wood screw Vis à bois CMP3A99	 P
Dowel Tourillon CMR3A99	 R

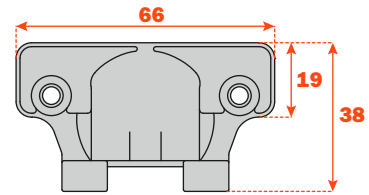

Single pivot hinges.
270° opening angle.
Bright nickel plated die-cast cup and arm.
Integrated stay close feature.

Ideal for the most critical applications, where high stability, strength and endurance are required. They are certified for applications in public environments in conformity with FIRA Level 5 and ANSI Grade 1 requirements.

Adjustments.

Side adjustment +3 mm to -3 mm with 3 mm mounting plate, +3 mm to -1 mm with 2 mm mounting plate and +3 mm to -0 mm with a 0 mm mounting plate.
 Height adjustment ± 2 mm.
 Depth adjustment with 200 series traditional mounting plates +2.8 mm.
 Depth adjustment with Domi snap-on mounting plates from -0.5 mm to +2.8 mm.
 Anti-sliding safety stop when using traditional plate.

Mounting plates.

Symmetrical and asymmetrical bright nickel plated steel or die-cast 200 series mounting plates.
 Snap-on assembly on Domi mounting plates.
 Positioning with pre-determined stop on traditional 200 series mounting plates.

IMPORTANT : Use POZIDRIVE No. 2 screwdrivers for all screws.

Charnières à un axe.
Angle d'ouverture à 270°.
Bras et boîtier en zamak nickelé mat.
Fermeture automatique (avec ressort).

Idéales pour les applications les plus difficiles, qui nécessitent une grande stabilité et une résistance dans le temps. Certifiées pour les applications dans les environnements publics selon les normes FIRA Niveau 5 et ANSI Degré 1.

Réglages.

Réglage latéral compensé de -3 mm à +3 mm avec embase H=3, de +3 mm à -1 mm avec embase H=2 mm et de +3 mm à -0 mm avec embase H=0 mm.
 Réglage vertical ± 2 mm.
 Réglage frontal avec embases Série 200 +2.8 mm.
 Réglage frontal avec embases Domi de -0.5 mm à +2.8 mm.
 Dispositif d'arrêt de sécurité.

Embases.

Embases symétriques et asymétriques en acier ou en zamak nickelé mat de la Série 200.
 Fixation rapide sur embases Domi.
 Positionnement avec butée en fin de course sur embases traditionnelles de la Série 200.
N.B. : Utiliser le tournevis POZIDRIVE n° 2 pour toutes les vis.



Packaging - 100 · Emballages - 100

Use these formulas to determine the height of the mounting plate "H" which is necessary to solve each application problem.

Utiliser ces formules pour définir la hauteur de l'embase "H" nécessaire pour résoudre chaque problème d'application.

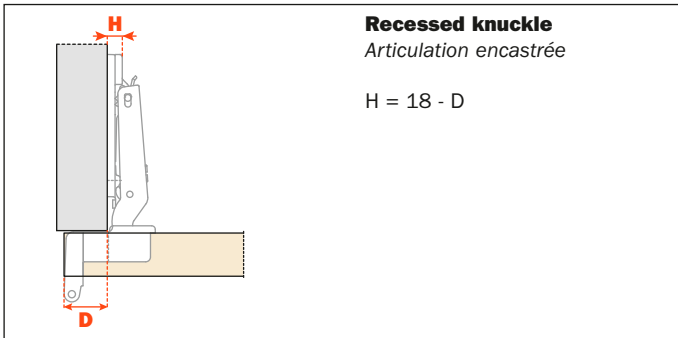

Recessed knuckle
Articulation encastrée

$H = 18 - D$

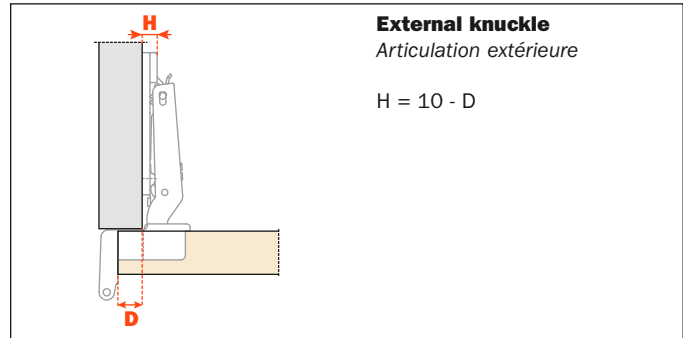

External knuckle
Articulation extérieure

$H = 10 - D$

Use the chart below to verify that full 270° opening is possible.

Full 270° opening is possible only with R value ≥ 0 and mounting plates H=0 mm. Otherwise the actual opening must be checked with a practical test.



Tableau pour la vérification de l'ouverture à 270°.

L'ouverture à 270° est possible seulement avec valeur $R \geq 0$ et embases H=0 mm. Dans le cas contraire, l'ouverture réelle doit être vérifiée par un test.

		Door thickness T Épaisseur de la porte T		
		18	19	20
Side thickness S Épaisseur du côté S	20	2.25	1.25	0.25
	19	3.25	2.25	1.25
	18	4.25	3.25	2.25
R value Valeur R				

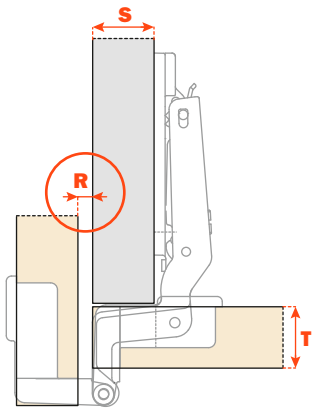
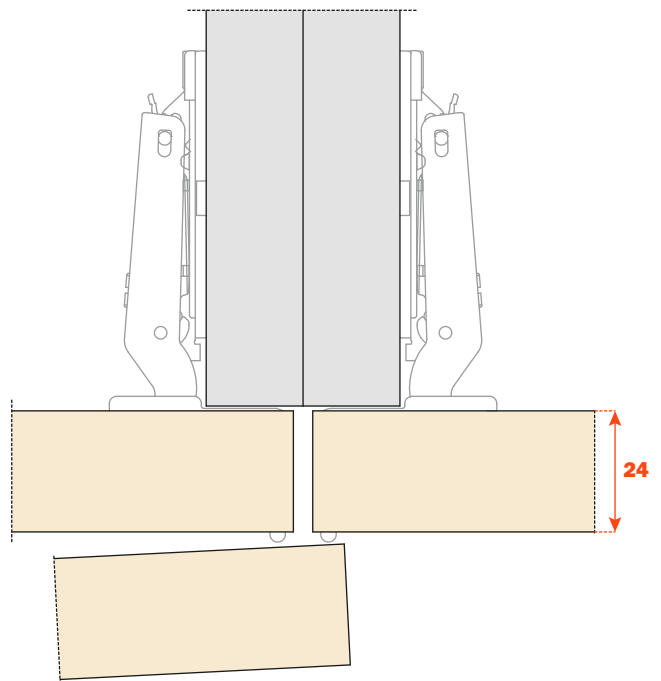

180° opening with door thickness max. 24 mm.

Ouverture à 180° avec portes d'épaisseur max. 24 mm.

Single pivot hinge • 270° opening
Charnière à un axe • Ouverture à 270°

Application with recessed knuckle
Application avec articulation encastrée

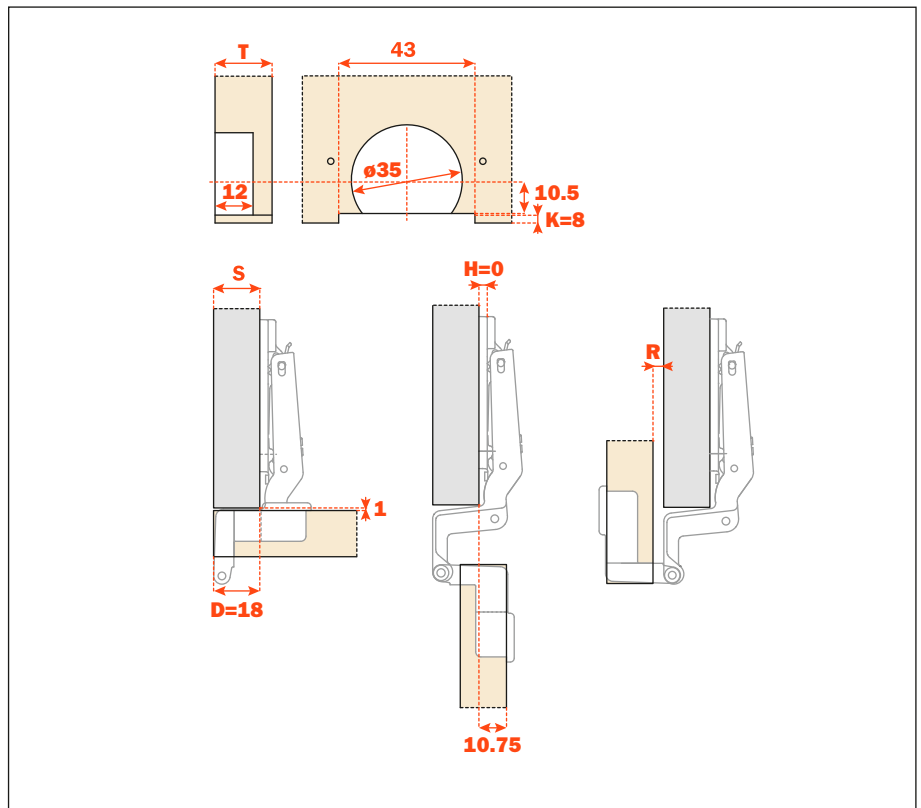

Application with external knuckle
Application avec articulation extérieure

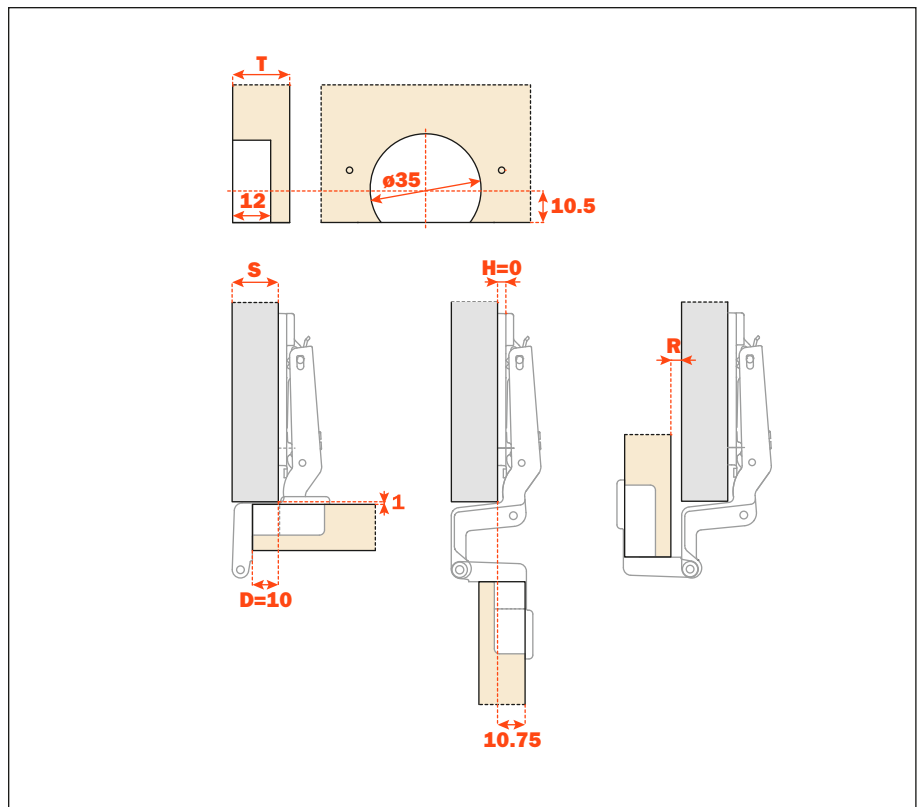

Application with inset door

Application avec porte rentrante

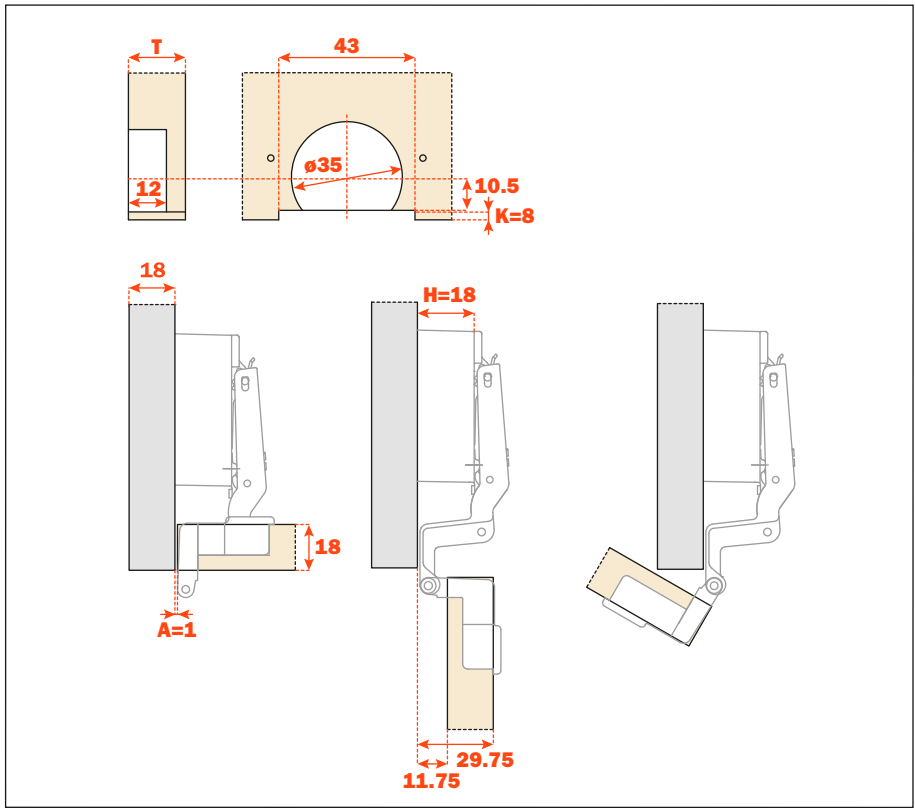

Application with half overlay door

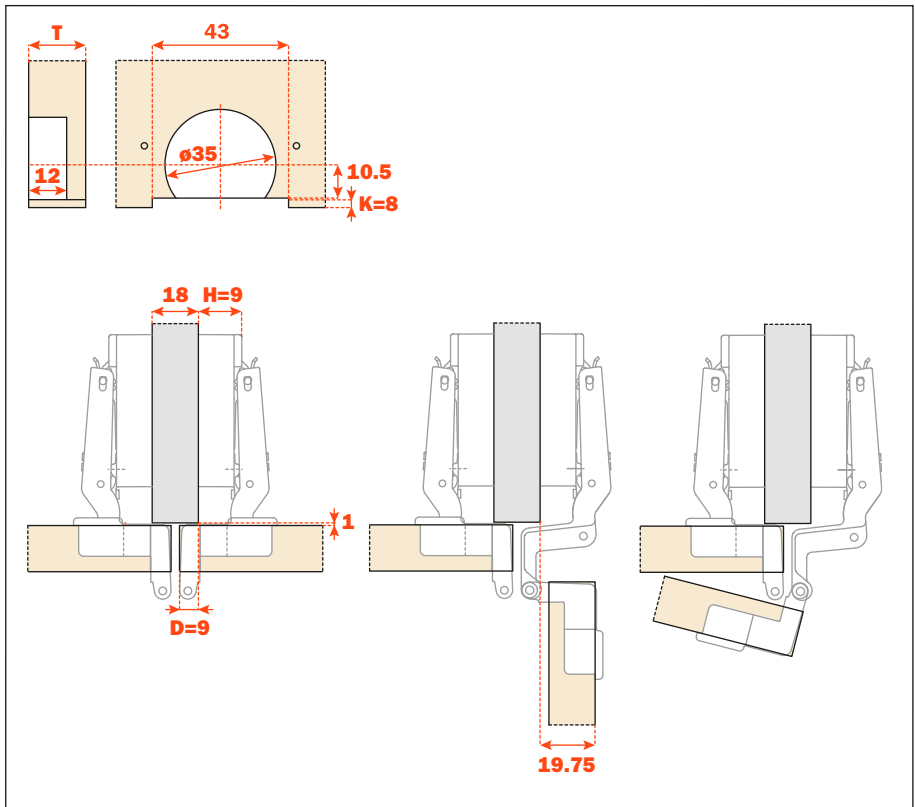

Application pour porte jumelées

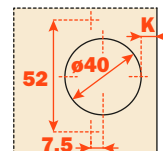

F series • For thick doors up to 1- 1/2" and other special applications
Série F • Pour portes épaisses jusqu' à 1 1/2" et d'autres applications spéciales

	94° ø40	Packaging Emballage
		





F/S		CFA5A99	300
S/C		CFA7A99	300

This series has been designed to solve unusual application problems. For example, heavy thick doors (inset up to 40 mm) or overlays up to 34 mm. Also, the hinge of choice for pocket door applications.

Cup depth 13 mm, cup diameter 40 mm, opening 94 degrees, K = 3 to 15 mm.

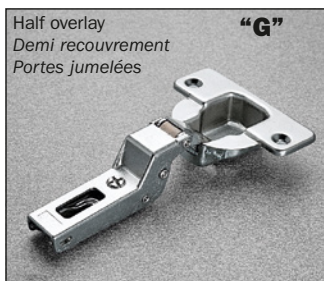
Compensating side adjustment
-0.5 mm +5.5 mm.





F/S		CFA5G99	300
S/C		CFA7G99	300

Cette série a été conçue pour résoudre des problèmes d'application peu courants. Exemple: portes lourdes et très épaisses (jusqu'à 40 mm) ou pour recouvrement jusqu'à 34 mm.

Aussi la charnière à choisir pour portes rétractables. Profondeur du boîtier 13 mm, diamètre du boîtier 40 mm, ouverture à 94°, K = de 3 à 15 mm.



F/S		CFA5P99	300
S/C		CFA7P99	300

Réglage compensé de côté
-0.5 mm + 5.5 mm.

"C" value

With this formula you can obtain the max. thickness of the moulded door that can be opened without touching adjacent carcase sides, doors or walls, whilst bearing in mind the above L-K-T values.

L'encombrement

Par cette formule vous pouvez obtenir l'épaisseur maximum de la porte ouverte sans interférer avec côtés, portes ou parois adjacentes. Il faut aussi toujours tenir compte du tableau des valeurs L - K - T.

$$C=22.5 + K + A$$

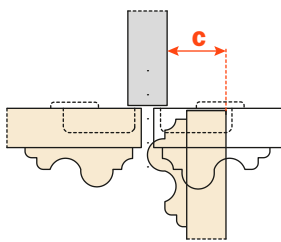
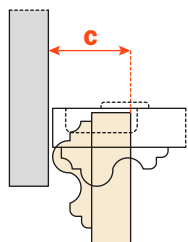

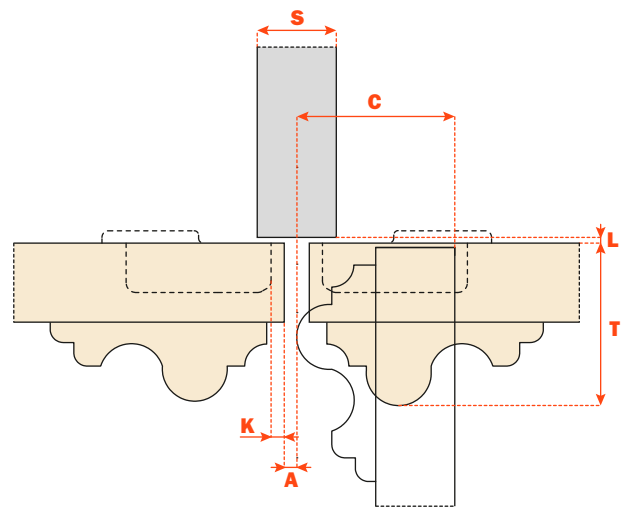
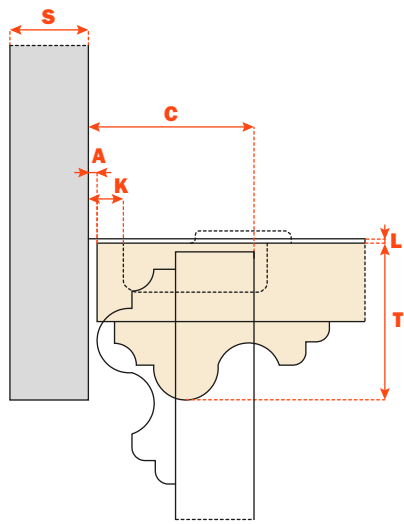

Overlay charts
Graphiques de recouvrement

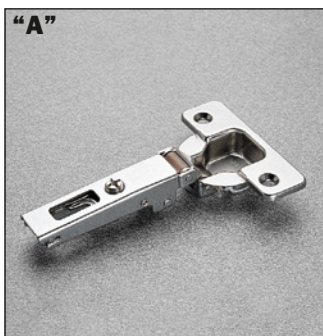

Full Overlay Hinge • Plein recouvrement Porte en applique

Hinge drilling pattern using "K" of 4 mm
Schéma de perçage avec "K" de 4 mm

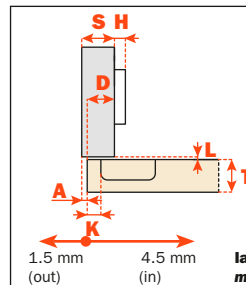
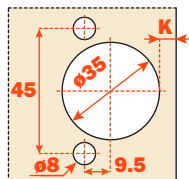

Full overlay
constant = 15 mm
Porte en applique
constante = 15 mm
 $D = (15 + K) - H$

The OVERLAY values shown in the table below were calculated by using the following formula:

Required overlay (D) = (Hinge constant of 15 mm plus TAB value (K) minus the plate thickness (H).

Example: $D = (15 + K) - H$ or $19 \text{ mm} = (15 + 4) - 0$

Les valeurs RECOUVREMENT indiquées dans le tableau ci-dessous ont été calculées avec la formule suivante:

Recouvrement désiré (D) = (constante de la charnière de 15 mm plus la distance de perçage (K) moins l'épaisseur de l'embase (H).

Exemple : $D = (15 + K) - H$ ou $19 \text{ mm} = (15 + 4) - 0$

Salice's preferred TAB (K)
Distance de perçage (K) préférée de Salice

Applies only to 94° and 165° hinges
Uniquement pour charnières avec ouverture 94° et 165°

Applies only to 94° and 155° thick door hinges
Uniquement pour charnières avec ouverture 94° et 155° pour portes épaisses

OVERLAY TABLE - TABLEAU RECOUVREMENT			Drilling Distance (TAB) - Distance de perçage (TAB)						
			K = 3 mm	K = 4 mm	K = 5 mm	K = 6 mm	K = 7 mm	K = 8 mm	K = 9 mm
Plate thickness Epaisseur de l'embase	Euro Plates Embases Euro	0 mm	18 mm	19 mm	20 mm	21 mm	22 mm	23 mm	24 mm
		2 mm	16 mm	17 mm	18 mm	19 mm	20 mm	21 mm	22 mm
		3 mm	15 mm	16 mm	17 mm	18 mm	19 mm	20 mm	21 mm
		6 mm	12 mm	13 mm	14 mm	15 mm	16 mm	17 mm	18 mm
		9 mm	9 mm	10 mm	11 mm	12 mm	13 mm	14 mm	15 mm
		12 mm	6 mm	7 mm	8 mm	9 mm	10 mm	11 mm	12 mm
	Face frame Face frame	18 mm	0 mm	1 mm	2 mm	3 mm	4 mm	5 mm	6 mm
		1 mm	17 mm	18 mm	19 mm	20 mm	21 mm	22 mm	23 mm
		4 mm	14 mm	15 mm	16 mm	17 mm	18 mm	19 mm	20 mm
		6 mm	12 mm	13 mm	14 mm	15 mm	16 mm	17 mm	18 mm



1/2" Overlay - Face frame • Recouvrement 1/2" - Face frame

Hinge drilling pattern using "K" of 4 mm
Schéma de perçage avec "K" de 4 mm

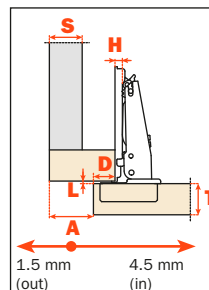
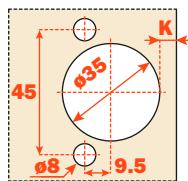

1/2" overlay hinge
constant = 10 mm

Recouvrement 1/2"
constante = 10 mm

$D = (10 + K) - H$

The OVERLAY values found in the table below were calculated by using the following formula:

Required overlay (D) = (Hinge constant of 10 mm plus TAB value (K) minus the plate thickness (H).

Example: $D = (10 + K) - H$ or $13 \text{ mm} = (10 + 4) - 1$

NA = Not Applicable

Les valeurs RECOUVREMENT indiquées dans le tableau ci-dessous ont été calculées avec la formule suivante:

Recouvrement désiré (D) = (constante de la charnière de 10 mm plus la distance de perçage (K) moins l'épaisseur de l'embase (H).

Exemple : $D = (10 + K) - H$ ou $13 \text{ mm} = (10 + 4) - 1$

NA = n'est pas applicable

Salice's preferred TAB (K)
Distance de perçage (K) préférée de Salice

Applies only to 94° and 165° hinges
Uniquement pour charnières avec ouverture 94° et 165°

Applies only to 94° and 155° thick door hinges
Uniquement pour charnières avec ouverture 94° et 155° pour portes épaisses

OVERLAY TABLE - TABLEAU RECOUVREMENT			Drilling Distance (TAB) - Distance de perçage (TAB)						
			K = 3 mm	K = 4 mm	K = 5 mm	K = 6 mm	K = 7 mm	K = 8 mm	K = 9 mm
Plate thickness Epaisseur de l'embase	Euro Plates Embases Euro	0 mm	13 mm	14 mm	15 mm	16 mm	17 mm	18 mm	19 mm
		2 mm	11 mm	12 mm	13 mm	14 mm	15 mm	16 mm	17 mm
		3 mm	10 mm	11 mm	12 mm	13 mm	14 mm	15 mm	16 mm
		6 mm	7 mm	8 mm	9 mm	10 mm	11 mm	12 mm	13 mm
		9 mm	4 mm	5 mm	6 mm	7 mm	8 mm	9 mm	10 mm
		12 mm	1 mm	2 mm	3 mm	4 mm	5 mm	6 mm	7 mm
	Face frame Face frame	18 mm	NA	NA	-3 mm	-2 mm	-1 mm	0 mm	1 mm
		1 mm	12 mm	13 mm	14 mm	15 mm	16 mm	17 mm	18 mm
		4 mm	9 mm	10 mm	11 mm	12 mm	13 mm	14 mm	15 mm
		6 mm	7 mm	8 mm	9 mm	10 mm	11 mm	12 mm	13 mm



Half overlay • Demi recouvrement Portes jumelées

Hinge drilling pattern using "K" of 4 mm
Schéma de perçage avec "K" de 4 mm

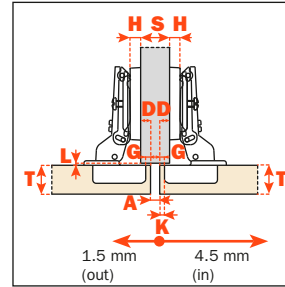
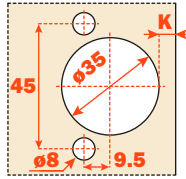

Half overlay hinge constant = 6 mm

Portes jumelées constante = 6 mm

$D = (6 + K) - H$

lateral adjustment series
marge de réglage latéral

The OVERLAY values found in the table below were calculated by using the following formula:

Required overlay (D) = (Hinge constant of 6 mm plus TAB value (K) minus the plate thickness (H).

Example: $D = (6 + K) - H$ or 10 mm = (6 + 4) - 0

NA = Not Applicable

Les valeurs RECOUVREMENT indiquées dans le tableau ci-dessous ont été calculées avec la formule suivante:

Recouvrement désiré (D) = (constante de la charnière de 6 mm plus la distance de perçage (K) moins l'épaisseur de l'embase (H).

Exemple: $D = (6 + K) - H$ ou 10 mm = (6 + 4) - 0

NA = n'est pas applicable

Salice's preferred TAB (K)
Distance de perçage (K) préférée de Salice

Applies only to 94° and 165° hinges
Uniquement pour charnières avec ouverture 94° et 165°

Applies only to 94° and 155° thick door hinges
Uniquement pour charnières avec ouverture 94° et 155° pour portes épaisses

OVERLAY TABLE - TABLEAU RECOUVREMENT			Drilling Distance (TAB) - Distance de perçage (TAB)						
			K = 3 mm	K = 4 mm	K = 5 mm	K = 6 mm	K = 7 mm	K = 8 mm	K = 9 mm
Plate thickness Epaisseur de l'embase	Euro Plates Embases Euro	0 mm	9 mm	10 mm	11 mm	12 mm	13 mm	14 mm	15 mm
		2 mm	7 mm	8 mm	9 mm	10 mm	11 mm	12 mm	13 mm
		3 mm	6 mm	7 mm	8 mm	9 mm	10 mm	11 mm	12 mm
		6 mm	3 mm	4 mm	5 mm	6 mm	7 mm	8 mm	9 mm
		9 mm	0 mm	1 mm	2 mm	3 mm	4 mm	5 mm	6 mm
		12 mm	-3 mm	-2 mm	-1 mm	0 mm	1 mm	2 mm	3 mm
	18 mm	NA	NA	NA	NA	NA	NA	-3 mm	
	Face frame Face frame	1 mm	8 mm	9 mm	10 mm	11 mm	12 mm	13 mm	14 mm
		4 mm	5 mm	6 mm	7 mm	8 mm	9 mm	10 mm	11 mm
6 mm		3 mm	4 mm	5 mm	6 mm	7 mm	8 mm	9 mm	



Inset • Application intérieure Encastrée

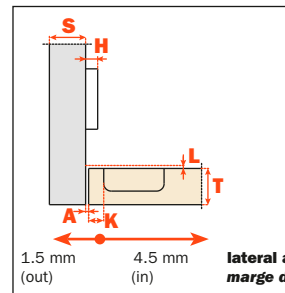
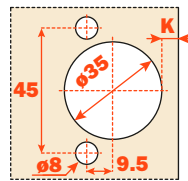

Inset hinge constant = -2 mm

Porte rentrante constante = -2 mm

$H = (-2 + K) + A$

lateral adjustment series
marge de réglage latéral

The OVERLAY values found in the table below were calculated by using the following formula:

Required plate height (H) = (Hinge constant of -2 mm plus TAB value (K) plus the "A" value (Gap).

Example: If a 1 mm gap is desired and drilling at 4 mm, use the formula $H = (-2 + K) + A$. $H = (-2 + 4) + 1$ or $H = 3$ mm.

NA = Not Applicable

Les valeurs RECOUVREMENT indiquées dans le tableau ci-dessous ont été calculées avec la formule suivante:

Hauteur de l'embase désirée (H) = (constante de la charnière de -2 mm plus la distance de perçage (K) plus la valeur "A" (jeu)

Exemple: si la valeur jeu "A" est 1 mm et le perçage est 4 mm, utiliser la formule: $H = (-2 + K) + A$. $H = (-2 + 4) + 1$ ou hauteur = 3 mm

NA = n'est pas applicable

Salice's preferred TAB (K)
Distance de perçage (K) préférée de Salice

Applies only to 94° and 165° hinges
Uniquement pour charnières avec ouverture 94° et 165°

Applies only to 94° and 155° thick door hinges
Uniquement pour charnières avec ouverture 94° et 165° pour portes épaisses

OVERLAY TABLE - TABLEAU RECOUVREMENT			Drilling Distance (TAB) - Distance de perçage (TAB)						
			K = 3 mm	K = 4 mm	K = 5 mm	K = 6 mm	K = 7 mm	K = 8 mm	K = 9 mm
Plate thickness Epaisseur de l'embase	Euro Plates Embases Euro	0 mm	+1 mm	NA	NA	NA	NA	NA	NA
		2 mm	-1 mm	0 mm	+1 mm	NA	NA	NA	
		3 mm	-2 mm	-1 mm	0 mm	+1 mm	NA	NA	
		6 mm	NA	NA	-3 mm	-2 mm	-1 mm	0 mm	+1 mm
		9 mm	NA	NA	NA	NA	NA	-3 mm	-2 mm
	Face frame Face frame	NA							







Mounting plates
Embases

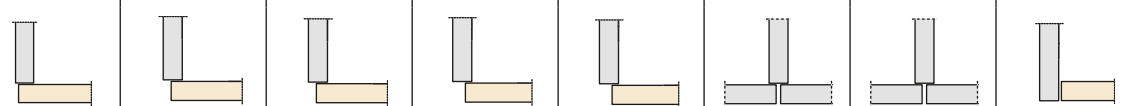

Mounting plates - The Slide-on mounting plate system
Embases à fixation ordinaire - A visser



The chart is based upon using a full overlay, "A" crank style, straight arm hinge with the combination of the baseplate thickness noted.
 Les tableaux sont basés sur une application avec porte en applique, charnière bras « A », en combinaison avec l'épaisseur d'embase indiqué.



<p>Based on using full overlay hinges with a 15mm constant.</p> <p>Basé sur une application avec porte en applique avec constante 15 mm</p>	<p>Baseplate Thickness 0mm</p> <p>Side panel 19mm</p> <p>Full overlay</p>	<p>Baseplate Thickness 2mm</p> <p>Side panel 16 mm</p> <p>Full overlay</p>	<p>Baseplate Thickness 3mm</p> <p>Side panel 16 mm</p> <p>Full overlay</p>	<p>Baseplate Thickness 4mm</p> <p>Side panel 16 mm</p> <p>Full overlay</p>	<p>Baseplate Thickness 6mm</p> <p>1/2"</p> <p>overlay Partial overlay</p>	<p>Baseplate Thickness 9mm</p> <p>Side panel 19 mm</p> <p>Half overlay</p>	<p>Baseplate Thickness 12mm</p> <p>Side panel 16 mm</p> <p>Half overlay</p>	<p>Baseplate Thickness 18mm</p> <p>Inset</p> <p>Epaisseur embase 18mm</p> <p>Porte rentrante</p>	<p>Packaging Emballage</p>
	<p>Epaisseur embase 0mm</p> <p>Panneau latéral 19 mm</p> <p>Porte en applique</p>	<p>Epaisseur embase 2mm</p> <p>panneau latéral 16 mm</p> <p>Porte en applique plus jeu</p>	<p>Epaisseur embase 3mm</p> <p>panneau latéral 16 mm</p> <p>Porte en applique</p>	<p>Epaisseur embase 4mm</p> <p>panneau latéral 16 mm</p> <p>Porte en applique plus jeu</p>	<p>Epaisseur embase 6 mm</p> <p>1/2"</p> <p>recouvrement Face frame à encadrement</p>	<p>Epaisseur embase 9mm</p> <p>panneau latéral 19 mm</p> <p>Porte jumelée</p>	<p>Epaisseur embase 12mm</p> <p>panneau latéral 16 mm</p> <p>Porte jumelée</p>		

 <p>37x32 Screw-in 37x32 A visser</p>									
<p>Steel - Acier</p> 	B2V3H09/15	B2V3H29/15	B2V3H39/15	B2V3H49/15	B2V3H69/15	B2V3H99/15	B2V3BC9/15*	B2V3BV9/15*	600 300*

 <p>37x32 Screw-in Euro screw pre mounted 37x32 A visser vis euro</p>									
<p>Steel - Acier</p> 	B2VGH09/17	B2VGH29/17	B2VGH39/17	B2VGH49/17	B2VGH69/17	B2VGH99/17	B2VGC9/15	B2VGBV9/15*	600 300*

 <p>37x32 Screw-in Height adjustment by cam 37x32 A visser - réglage vertical par vis excentrique</p>									
<p>Die-cast - Zamak</p> 	B2R3E09/15		B2R3E39/15		B2R3E69/15*	B2R3E99/15*			600 300*

 <p>37x32 Screw-in Euro screw pre mounted - Height adjustment by cam 37x32 A visser vis euro - Réglage vertical par vis excentrique</p>									
<p>Die-cast - Zamak</p> 	B2RGE09/17		B2RGE39/17		B2RGE69/17*	B2RGE99/17*			600 300*

 <p>37x32 Screw-in Ø5 Premounted ø5 mm expandable dowel 37x32 A visser Ø5 Goujons à expansion ø5 mm</p>									
<p>Steel - Acier</p> 	B2V4H09/17	B2V4H29/17	B2V4H39/17	B2V4H49/17	B2V4H69/17				600

Mounting plates - The slide-on mounting plates system for special angle assembly - 3 way adjustment

Embases à fixation ordinaire - A visser - Pour des applications spéciales

An almost infinite variety of angled door applications is possible using variable-angle mounting plates in conjunction with one of Salice's range of angled-arm hinges.

En accouplant les embases Salice pour montage spéciaux avec les différents bras des charnières, il est possible d'obtenir d'innombrables solutions de montage d'angle des portes.

		Packaging Emballage			Packaging Emballage			Packaging Emballage2
	37x32 Screw-in 37x32 A visser			Euro screw pre-mounted. Vis Euro.			Screw-in. A visser.	
Die-cast - Zamak			Die-cast - Zamak			Die-cast - Zamak		
	B2V3BW9/15	600		B2VGBW9/17	600		B2V3BW9R/15	600
	Screw-in. Euro screw pre-mounted. A visser vis Euro.			Screw-in. A visser.			Screw-in. Euro screw pre-mounted. A visser vis Euro.	
Die-cast - Zamak			Die-cast - Zamak			Die-cast - Zamak		
	B2VGBW9R/17	600		B2V3BW9S/15	300		B2VGBW9S/17	300

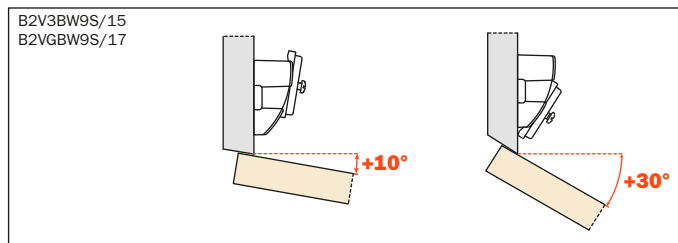
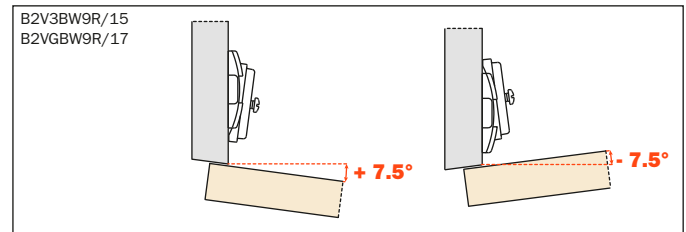
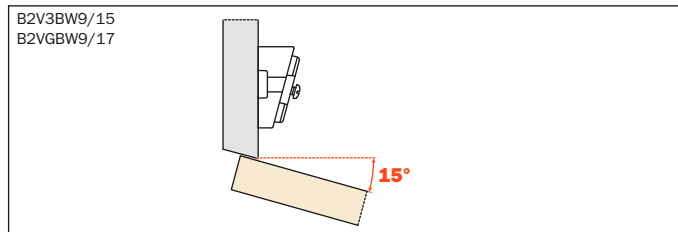

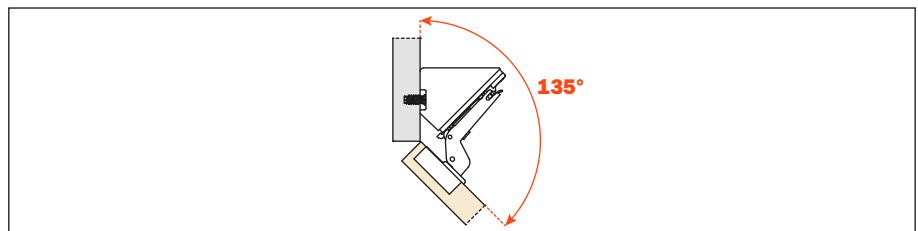

	Screw-in. A visser.	
Die-cast - Zamak		
	BAR3RW9M	150



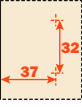

Variable-angle adapters

Die-cast adapters for all mounting plates.

	Die-cast adapter +5°. Fixing: wood screw $\varnothing 6 \times \frac{3}{4}$ " Adaptateur en zamak +5°. Fixation vis à bois. $\varnothing 6 \times \frac{3}{4}$ "	
		SAV354X9R

Adaptateurs inclinés

Adaptateurs en zamak pour toutes les embases.

	Die-cast adapter +10°. Fixing: wood screw $\varnothing 6 \times 1$ " Adaptateur en zamak +10°. Fixation vis à bois. $\varnothing 6 \times 1$ "	
		SAV354X9S

* Can be used with straight arm plates (BAP) or wing style plates (BAV, BAR)

** When stacked, use wood screw $\varnothing 6 \times 1 - \frac{1}{4}$ "











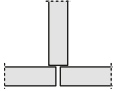
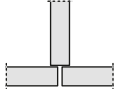





*** Stacking the adapters will allow the achievement of a 15° angle

* Peut être utilisé avec les embases longitudinales (BAP) ou cruciformes (BAV, BAR)

** Pour la fixation utiliser une vis à bois $\varnothing 6 \times 1 - \frac{1}{4}$ "

*** En fixant les adaptateurs, on obtient un angle de 15°

Mounting plates • snap on - 2-way adjustment - 1 cam
Embases • à fixation rapide - 2 réglages - 1 vis excentrique

<p>Based on using full overlay hinges</p> <p>Utilisation avec plein recouvrement, porte en applique</p>	<p>9 mm Side panel 19 mm Half overlay</p> <p>Côté 19 mm Demi recouvrement</p> 	<p>12 mm Side panel 16 mm Half overlay</p> <p>Côté 16 mm Demi recouvrement</p> 	<p>18 mm Inset</p> <p>Application intérieure</p> 	Packaging Emballage	
	<p>37x32 Screw-in 37x32 A visser</p>				
<p>Die-cast - Zamak</p> 	<p>Die cast Zamak BAV3E99F</p>	<p>Die cast Zamak BAV3EC9F</p>	<p>Die cast Zamak BAV3EV9F</p>		300
	<p>37x32 Screw-in. Euro screw pre-mounted. 37x32 A visser. Eurovis prémonté.</p>				
<p>Die-cast - Zamak</p> 	<p>Die cast Zamak BAVGE99F/16</p>	<p>Die cast Zamak BAVGEC9F/16</p>	<p>Die cast Zamak BAVGEV9F/16</p>		300
<p>New steel mounting plates</p> <p>Nouvelles embases en acier</p>	<p>0 mm Side panel 19 mm Full overlay</p> <p>Côté 19 mm Plein recouvrement</p> 	<p>2 mm Side panel 16 mm Full overlay</p> <p>Côté 16 mm Recouvrement</p> 	<p>4 mm Side panel 16 mm Full overlay</p> <p>Côté 16 mm Plein recouvrement</p> 	<p>6 mm $\frac{1}{2}$" overlay Partial overlay</p> <p>Recouvrement $\frac{1}{2}$" Recouvrement partiel</p> 	
	<p>37x32 Screw-in 37x32 A visser.</p>				
<p>Steel - Acier</p> 	<p>BAV3M09F</p>	<p>BAV3M29F</p>	<p>BAV3M49F</p>	<p>BAV3M69F</p>	300
	<p>37x32 Screw-in. Euro screw pre-mounted. 37x32 A visser. Eurovis prémonté.</p>				
<p>Steel - Acier</p> 	<p>BAVGM09F/16</p>	<p>BAVGM29F/16</p>	<p>BAVGM49F/16</p>	<p>BAVGM69F/16</p>	300
	<p>37x32 Screw-in. Expansion dowels ø 5 mm 37x32 A visser. Tourillons à expansion ø 5 mm.</p>				
<p>Steel - Acier</p> 	<p>BAV4M09F/16</p>	<p>BAV4M29F/16</p>	<p>BAV4M49F/16</p>		300

Snap on - 2-way adjustment - 2 cams
A fixation rapide - 2 réglages - 2 vis excentriques









The Domi automatic mounting plate system - 2-way adjustment
Domi plate with AAR feature.

The **Salice Domi** mounting plate has a unique **Automatic Adjustment Response** feature: a slight turn of the depth adjustment cam or vertical adjustment cam quickly positions the hinge - eliminating the need for manual positioning by loosening screws.

Embases Domi à fixation rapide - 2 réglages

Embase Domi avec fonction RRA.

L'Embase Domi de Salice a une fonction unique de **Réponse de Régulation Automatique**: une rotation rapide de la vis excentrique pour le réglage frontal ou vertical, positionne automatiquement la charnière - éliminant ainsi le besoin de positionnement manuel.

<p>Based on using full overlay hinges.</p> <p>Utilisation avec plein recouvrement, porte en applique.</p>	<p>0 mm Side panel 19 mm Full overlay</p> <p>Côté 19 mm Plein recouvrement</p> 	<p>3 mm Side panel 16 mm Full overlay</p> <p>Côté 16 mm Plein recouvrement</p> 	<p>4mm Side panel 16 mm Full overlay</p> <p>Panneau latéral 16 mm Porte en applique plus jeu</p> 	<p>6 mm $\frac{1}{2}$" overlay Partial overlay</p> <p>Recouvrement $\frac{1}{2}$" Recouvrement partiel</p> 	<p>Packaging Emballage</p>
	<p>37x32 #7 x 5/8" wood screw. 37x32 vis à bois #7 x 5/8".</p>				
<p>Die-cast - Zamak</p> 	<p>BAR3L09F</p>	<p>BAR3L39F</p>	<p>BAR3L49F</p>	<p>BAR3L69F</p>	<p>300</p>
	<p>37x32 Screw-in. Euro-screw pre-mounted. 37x32 A visser. Eurovis pré-monté.</p>				
<p>Die-cast - Zamak</p> 	<p>BARGL09F/16</p>	<p>BARGL39F/16</p>	<p>BARGL49F/16</p>	<p>BARGL69F/16</p>	<p>300</p>

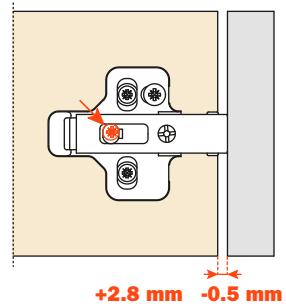
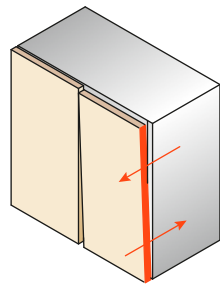
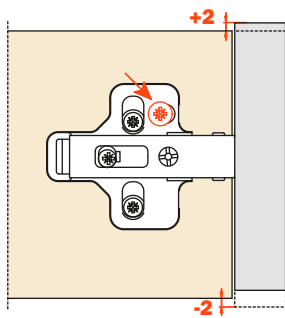
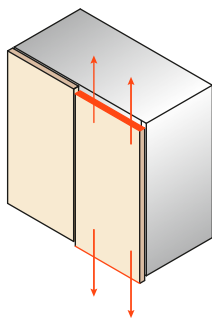

Height adjustment by cam
Réglage vertical par vis excentrique

+2 mm
-2 mm

Depth adjustment by cam
Réglage frontal par vis excentrique

+2.8 mm
-0.5 mm

Mounting plates • snap on - 2-way adjustment - 2 cams

Embases • à fixation rapide - 2 réglages - 2 vis excentriques

The Domi automatic mounting plate system - 2-way adjustment

Dom plate with AAR feature.

The **Salice Domi** mounting plate has a unique **Automatic Adjustment Response** feature: a slight turn of the depth adjustment cam or vertical adjustment cam quickly positions the hinge - eliminating the need for manual positioning by loosening screws.

Embases Domi à fixation rapide - 2 réglages

Embase Domi avec fonction RRA.

L'Embase **Domi** de **Salice** a une fonction unique de **Réponse de Régulation Automatique**: une rotation rapide de la vis excentrique pour le réglage frontal ou vertical, positionne automatiquement la charnière - éliminant ainsi le besoin de positionnement manuel

Based on using full overlay hinges. Utilisation avec plein recouvrement, porte en applique.	0 mm Side panel 19 mm Full overlay Côté 19 mm Plein recouvrement	2 mm Side panel 16 mm Full overlay Côté 16 mm Recouvrement	3 mm Side panel 16 mm Full overlay Côté 16 mm Plein recouvrement	4 mm Side panel 16 mm Full overlay Côté 16 mm Plein recouvrement	6 mm 1/2" overlay Partial overlay Recouvrement 1/2" Recouvrement partiel	9 mm Side panel 19 mm Half overlay Côté 19 mm Demi recouvrement	12 mm Side panel 16 mm Half overlay Côté 16 mm Demi recouvrement	Packaging Emballage

 21+32 Screw-in 21+32 A visser								
Die-cast - Zamak 	BAP3R09	BAP3R29	BAP3R39	BAP3R49	BAP3R69	BAP3R99	BAP3RC9	300

 21+32 Screw-in. Euro-screw pre-mounted. 21+32 A visser. Eurovis pré-monté.								
Die-cast - Zamak 	BAPGR09/16	BAPGR29/16	BAPGR39/16	BAPGR49/16	BAPGR69/16			300

 21+32 Knock-in. Dowels ø 10 mm. 21+32 Tourillons à pression ø 10 mm.								
Die-cast - Zamak 	BAP7R09	BAP7R29	BAP7R39	BAP7R49	BAP7R69			300

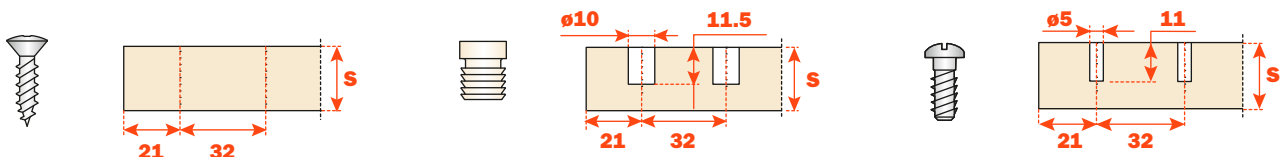

Snap on - 2-way adjustment - 2 cams

A fixation rapide - 2 réglages - 2 vis excentriques









The Domi automatic mounting plate system - 2-way adjustment • Domi plate with AAR feature.



The **Salice Domi** mounting plate has a unique **A**utomatic **A**djustment **R**esponse feature: a slight turn of the depth adjustment cam or vertical adjustment cam quickly positions the hinge - eliminating the need for manual positioning by loosening screws.



Embases Domi à fixation rapide - 2 réglages



Embase Domi avec fonction RRA.



L'Embase Domi de Salice a une fonction unique de **R**éponse de **R**égulation **A**utomatique: une rotation rapide de la vis excentrique pour le réglage frontal ou vertical, positionne automatiquement la charnière - éliminant ainsi le besoin de positionnement manuel.

Based on using full overlay hinges. Utilisation avec plein recouvrement, porte en applique.	0 mm Side panel 19 mm Full overlay	2 mm Side panel 16 mm Full overlay	3 mm Side panel 16 mm Full overlay	4 mm Side panel 16 mm Full overlay	6 mm $\frac{1}{2}$ " overlay Partial overlay <i>Recouvrement $\frac{1}{2}$" Recouvrement partiel</i>	9 mm Side panel 19 mm Half overlay	12 mm Side panel 16 mm Half overlay	18 mm Inset <i>Application intérieure</i>	Packaging Emballage
	Côté 19 mm Plein recouvrement	Côté 16 mm Recouvrement	Côté 16 mm Plein recouvrement	Côté 16 mm Plein recouvrement	Côté 16 mm Plein recouvrement	Côté 19 mm Demi recouvrement	Côté 16 mm Demi recouvrement	       	

	37x32 Screw-in 3rd screw fixing option 37x32 A visser. Possibilité de fixation par 3^{ème} vis								
Die-cast - Zamak 	BAR3R09	BAR3R29	BAR3R39	BAR3R49	BAR3R69	BAR3R99	BAR3RC9	BAR3RV9	300

	37x32 Screw-in. Euro-screw pre-mounted. 3rd screw fixing option 37x32 A visser. Eurovis pré-monté. Possibilité de fixation par 3^{ème} vis								
Die-cast - Zamak 	BARGR09/16	BARGR29/16	BARGR39/16	BARGR49/16	BARGR69/16	BARGR99/16	BARGRC/16	BARGRV9/16	300

	Short euro screw plates for twin application Eurovis courte pour application jumelées								
	BARGR09/20	BARGR29/20	BARGR39/20	BARGR49/20	BARGR69/20	BARGR99/20			300

	37x32 Expansion Dowels ø5 mm. 3rd screw fixing option 37x32 Tourillons à expansion ø5 mm. Possibilité de fixation par 3^{ème} vis								
Die-cast - Zamak 	BAR4R09/16	BAR4R29/16	BAR4R39/16	BAR4R49/16	BAR4R69/16				300

Mounting plates • snap on - 2-way adjustment - 2 cams









Embases • à fixation rapide - 2 réglages - 2 vis excentriques

The Domi automatic mounting plate system - 2-way adjustment • Domi plate with AAR feature.



The **Salice Domi** mounting plate has a unique **Automatic Adjustment Response** feature: a slight turn of the depth adjustment cam or vertical adjustment cam quickly positions the hinge - eliminating the need for manual positioning by loosening screws.



Embases Domi à fixation rapide - 2 réglages Embase Domi avec fonction RRA.

L'Embase Domi de Salice a une fonction unique de **Réponse de Régulation Automatique**: une rotation rapide de la vis excentrique pour le réglage frontal ou vertical, positionne automatiquement la charnière - éliminant ainsi le besoin de positionnement manuel.



<p>Based on using full overlay hinges.</p> <p><i>Utilisation avec plein recouvrement, porte en applique.</i></p>	<p>21 mm Inset face frame application</p> <p><i>Application intérieure face frame</i></p> 	<p>24 mm Inset face frame application</p> <p><i>Application intérieure face frame</i></p> 	<p>27 mm Inset face frame application</p> <p><i>Application intérieure face frame</i></p> 	<p>30 mm Inset face frame application</p> <p><i>Application intérieure face frame</i></p> 	<p>Packaging Emballage</p>
	<p>37x32 Screw-in 3rd screw fixing option • Additional plate heights 37x32 A visser. Possibilité de fixation par 3^{ème} vis • Hauteurs supplémentaires des embases</p>				
<p>Die-cast - Zamak</p> 	<p>BAR3RZ9</p>	<p>BAR3RY9</p>	<p>BAR3RU9</p>	<p>BAR3RM9</p>	<p>150</p>
	<p>37x32 Screw-in. Euro-screw pre-mounted. 3rd screw fixing option • Additional plate heights 37x32 A visser. Eurovis prémonté. Possibilité de fixation par 3^{ème} vis • Hauteurs supplémentaires des embases</p>				
<p>Die-cast - Zamak</p> 	<p>BARGRZ9/16</p>	<p>BARGRY9/16</p>	<p>BARGRU9/16</p>	<p>BARGRM9/16</p>	<p>150</p>

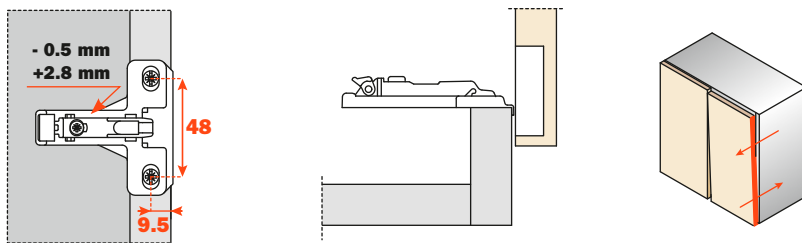

Snap on - 2-way adjustment - 1 cam and 2 cams
A fixation rapide - 2 réglages - 1 vis excentrique et 2 vis excentriques

<p>Face frame application. Based on using full overlay hinges.</p> <p>Application face frame. Utilisation avec plein recouvrement, porte en applique.</p>	<p>1 mm 3/4" overlay Recouvrement 3/4"</p> 	<p>4 mm 1/2" overlay Recouvrement 1/2"</p> 			Packaging Emballage

 <p>10x48 Screw-in. 10x48 A visser.</p>					
<p>Steel - Acier</p> 	BAU3L19	BAU3L49			300

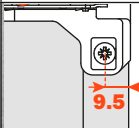
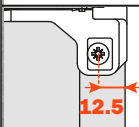

		<p>1 mm 3/4" overlay Recouvrement 3/4"</p> 	<p>4 mm 1/2" overlay Recouvrement 1/2"</p> 	<p>6 mm 1/2" overlay Recouvrement 1/2"</p> 	
--	--	---	--	---	--

 <p>10x48 Screw-in. 3rd screw fixing option. 10x48 A visser. Possibilité de fixation par 3ème vis.</p>					
<p>Die-cast - Zamak</p> 		BAU3R19	BAU3R49	BAU3R69	300
		BAU3R19XR	BAU3R49XR	BAU3R69XR	300

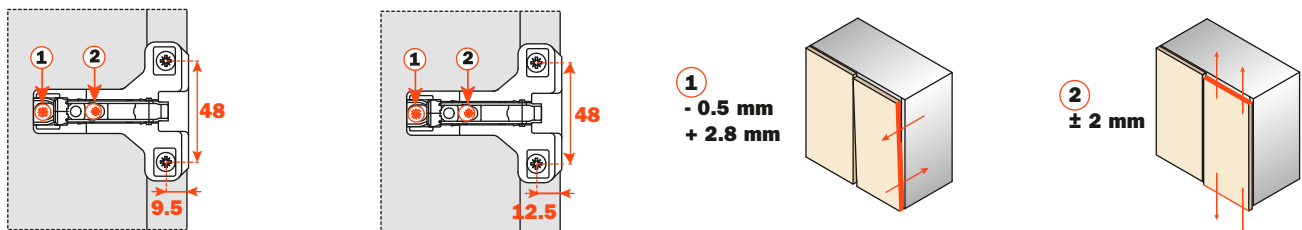

Mounting plates • 2-way adjustment - 2 cams

Embases • 2 réglages - 2 vis excentriques

Double cam - Inset face-frame applications • Vis excentrique double - Application intérieure face frame



7x32 Screw-in 7x32 A visser		Packaging Emballage
	BAL3R59	300

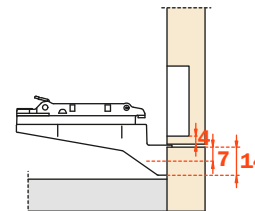
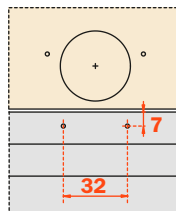

To be used with:

- 1) Half overlay hinges ("G" crank)
 - 2) 1/2" overlay hinges ("D" crank) + adjustment.
- Fix with #6 x 5/8" truss head recommended.

A utiliser avec:

- 1 - Demi recouvrement/Portes jumelées (bras "G")
 - 2 - Face frame à encadrement (bras "D") + réglage
- Nous recommandons la fixation avec vis à tête de ferme #6 x 5/8"

Double cam - Rear flange face-frame applications • Vis excentrique double - Pour les applications face frame à l'intérieur du cadre



10x45 Screw-in 10x45 A visser		Packaging Emballage
	BA03R59	150

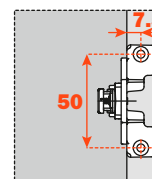
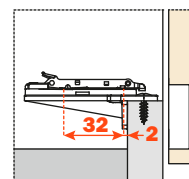
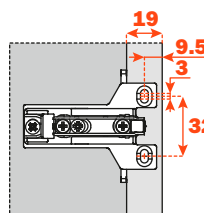

Overlay calculation:

Overlay = constant + Drilling distance - 5 mm

This wrap-around mounting plate allows attaching to both the edge of the frame as well as attaching to the back of the frame.

It is ideal for many specialized applications that include cabinet refacing when an up-to-6mm veneer is added to the face of the frame.

In this application, this plate design allows the fixing screws to remain in the center of the solid wood frame thus avoiding the joint between the frame and the surfacing material. Some manufacturers do not use solid wood framing material but other materials such as plywood or MDF. Since these materials do not provide suitable screw holding power on the edge of the material, this plate can be secured both to the back surface of the frame and the edge. This results in an acceptable, secure attachment.

Calculer le recouvrement :

Recouvrement = constante + distance de perçage - 5 mm

Cette embase enveloppante permet de la fixer aussi bien sur le bord du cadre qu'à l'arrière du cadre. Elle est idéal pour de nombreuses applications spécialisées y compris les revêtements du meuble lorsqu'un placage de jusqu'à 6 mm est ajouté à la face du cadre. Dans cette application, cette conception d'embase permet aux vis de fixation de s'enfoncer au centre du cadre en bois massif, évitant ainsi le joint entre le cadre et le matériau de recouvrement. Certains fabricants n'utilisent pas de matériaux en bois massif, mais d'autres matériaux tels que le contreplaqué ou le MDF. Étant donné que ces matériaux n'offrent pas une force de maintien de vis adéquate au bord du matériau, cette embase peut être fixée à la fois à la surface arrière du cadre et au bord. Il en résulte une fixation acceptable et sûre.

Double cam - Large overlay face-frame applications • Vis excentrique double - Pour les applications face frame à l'intérieur du cadre



10x45 Screw-in 10x45 A visser		Packaging Emballage
	BAM3R09	300

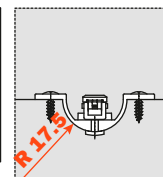
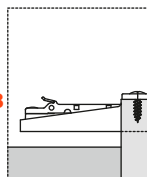
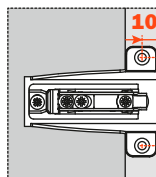

Overlay calculation:

Overlay = constant + Drilling distance + 11 mm

Calculer le recouvrement :

Recouvrement = constante + distance de perçage + 11 mm

Hinge Charnière	Overlay Recouvrement	Drilling distance (K) Distance de perçage (K)
Full Overlay ("A" crank) • 110° - 120° opening Plein recouvrement (bras "A") • ouverture 110° - 120°	1 - 1/4" overlay recouvrement 1 - 1/4"	K = 6 mm
Full Overlay ("A" crank) • 94° - 165° opening Plein recouvrement (bras "A") • ouverture 94° - 165°	1 - 3/8" overlay recouvrement 1 - 3/8"	K = 8 mm + 1 mm of adjustment K = 8 mm + réglage de 1 mm
Full Overlay ("A" crank) • 165° + reduction clip • S2AF37X3 = 125° opening Plein recouvrement (bras "A") • 165° + arrêt S2AF37X3 = ouverture 125°	1 - 1/2" overlay recouvrement 1 - 1/2"	K = 12 mm
Full Overlay ("A" crank) • 165° + reduction clip • S2AF37X3 = 125° opening Plein recouvrement (bras "A") • 165° + arrêt S2AF37X3 = ouverture 125°	1 - 9/16" overlay recouvrement 1 - 9/16"	K = 14 mm

Snap on - 2-way adjustment - 2 cams
A fixation rapide - 2 réglages - 2 vis excentriques

Hinge and mounting plate selection guide for Face Frame Inset doors.
Charnières et embases pour les applications face frame à l'intérieur du cadre

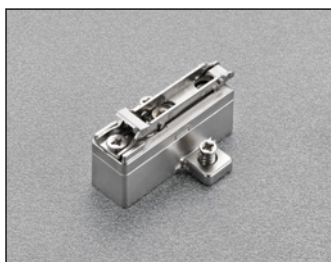

BAR_ mounting plate

BAR_ Embase



P_ crank inset hinge

P_ bras de la charnière pour application intérieure

Face frame cabinets

The **BAR** thick mounting plate system has been developed to offer the appropriate mounting plate thickness for inset doors with face frame cabinets. This eliminates the need to "build up" to match the face frame interspace (**IS**) dimension.

Muebles face frame

Le système des embases épaisses **BAR** a été développé pour offrir l'épaisseur appropriée de l'embase pour les portes encastrées avec des meubles face frame. Cela élimine le besoin de "augmenter" pour niveler la dimension correspondant à la distance (**IS**) entre le côté et le bord du cadre.

Mounting plate part number

Référence de l'embase

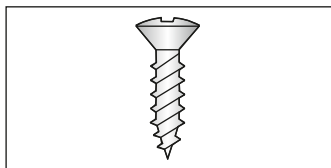

H = 6 mm - BAR3R69
H = 9 mm - BAR3R99
H = 12 mm - BAR3RC9
H = 18 mm - BAR3RV9
H = 21 mm - BAR3RZ9
H = 24 mm - BAR3RY9
H = 27 mm - BAR3RU9
H = 30 mm - BAR3RM9

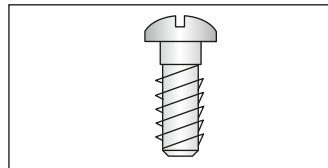

H = 6 mm - BARGR69/16
H = 9 mm - BARGR99/16
H = 12 mm - BARGRC9/16
H = 18 mm - BARGRV9/16
H = 21 mm - BARGRZ9/16
H = 24 mm - BARGRY9/16
H = 27 mm - BARGRU9/16
H = 30 mm - BARGRM9/16

3rd fixing screw hole from 0 mm to 12 mm.
 No 3rd fixing screw hole from 18 mm to 30 mm.

18 mm - 30 mm plates have larger screw holes requiring larger screws such as #7 X 5/8" wood screws.

3ème trou de vis de fixation de 0 mm à 12 mm.
 Pas de 3ème trou de vis de fixation de 18 mm à 30 mm.

Les embases de 18 mm à 30 mm ont des trous de vis plus grands nécessitant des vis plus grandes telles que des vis à bois #7 X 5/8".

3rd fixing screw hole from 0 mm to 12 mm.
 No 3rd fixing screw hole from 18 mm to 30 mm.

3ème trou de vis de fixation de 0 mm à 12 mm.
 Pas de 3ème trou de vis de fixation de 18 mm à 30 mm.

Drawings of Face Frame Inset applications
Dessins des applications intérieures face frame

Select an inset style (P crank) hinge and the matching mounting plate thickness for your cabinet design.
 Sélectionner une charnière bras P (application intérieure/encastée) et l'épaisseur de l'embase correspondant pour la conception de votre meuble.

IS = Flush	IS = Aligné
P = Inset hinge	P = Encastrée
H = 3 mm plate	H = Embase 3 mm
K = 4 mm	K = 4 mm
A = 2.5 mm	A = 2.5 mm
Adjust = +1.5 mm	Réglage = +1.5 mm

IS = 1/16"	IS = 1/16"
P = Inset hinge	P = Encastrée
H = 6 mm plate	H = Embase 6 mm
K = 4 mm	K = 4 mm
A = 2.5 mm	A = 2.5 mm
Adjust = 0 mm	Réglage = 0 mm

IS = 1/8"	IS = 1/8"
P = Inset hinge	P = Encastrée
H = 6 mm plate	H = Embase 6 mm
K = 4 mm	K = 4 mm
A = 2.5 mm	A = 2.5 mm
Adjust = +1.5 mm	Réglage = +1.5 mm

IS = 1/4"	IS = 1/4"
P = Inset hinge	P = Encastrée
H = 9 mm plate	H = Embase 9 mm
K = 4 mm	K = 4 mm
A = 2.5 mm	A = 2.5 mm
Adjust = +1.5 mm	Réglage = +1.5 mm

IS = 3/8"	IS = 3/8"
P = Inset hinge	P = Encastrée
H = 12 mm plate	H = Embase 12 mm
K = 4 mm	K = 4 mm
A = 2.5 mm	A = 2.5 mm
Adjust = +2 mm	Réglage = +2 mm

IS = 1/2"	IS = 1/2"
P = Inset hinge	P = Encastrée
H = 18 mm plate	H = Embase 18 mm
K = 4 mm	K = 4 mm
A = 2.5 mm	A = 2.5 mm
Adjust = -0.5 mm	Réglage = -0.5 mm

Legend

IS = recess (from side to frame edge)
B = mounting plate
H = mounting plate thickness
K = edge bore distance
A = gap
P = crank inset hinge

Abréviations

IS = distance entre le côté et le bord du cadre
B = embase
H = épaisseur de l'embase
K = distance de perçage du bord extérieur
A = jeu
P = bras de la charnière pour application intérieure

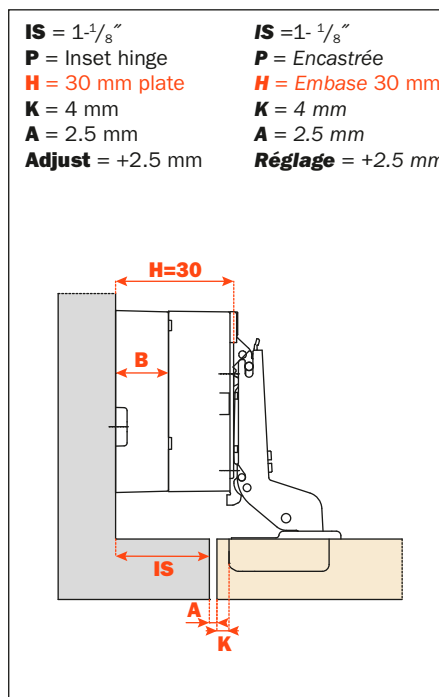
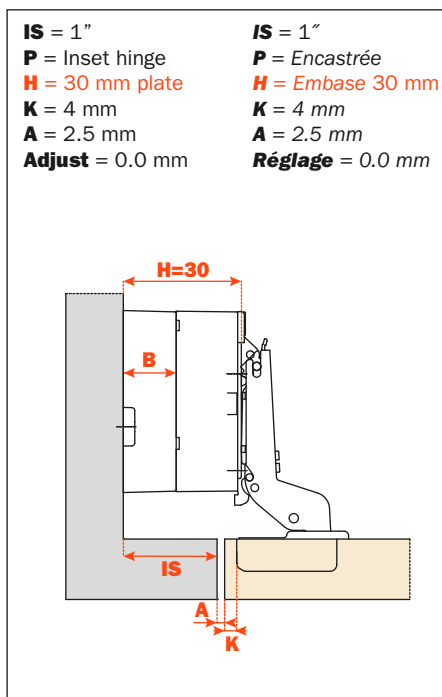
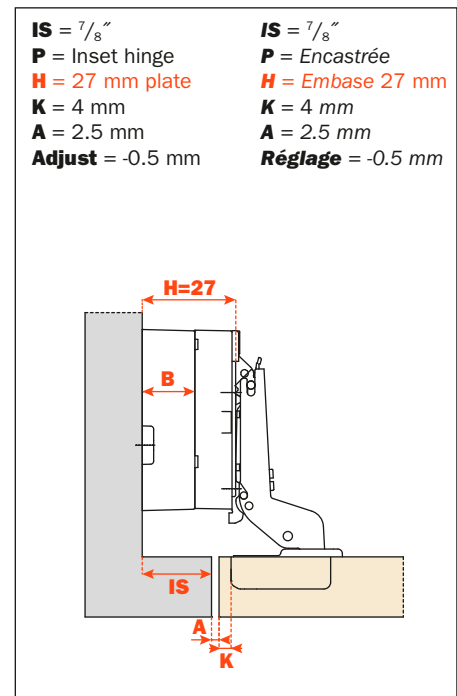
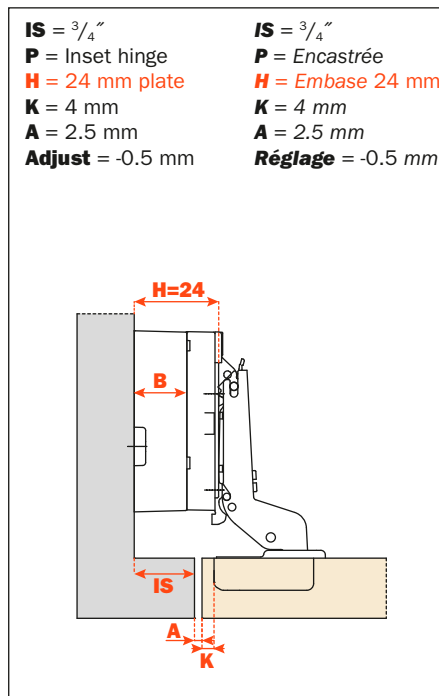
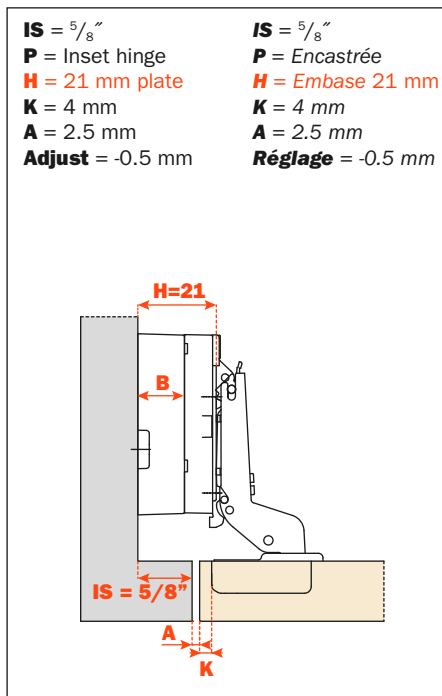

eocentra

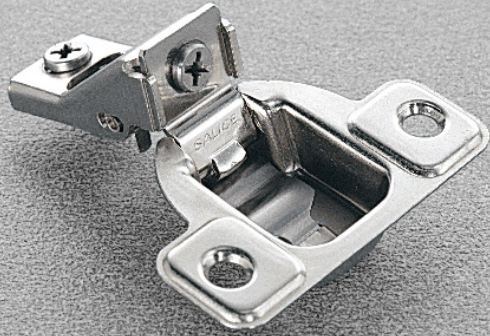

eocen *three*

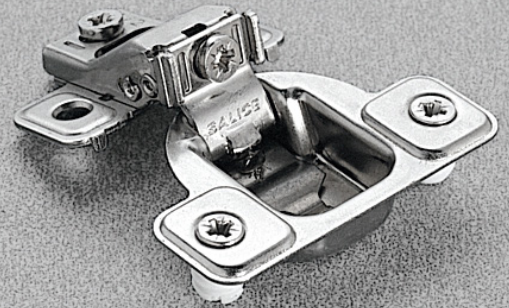

S series • Série S

S series Série S



"Face-Frame" • 2 cam adjustable "Face-Frame" • 2 vis excentriques réglables

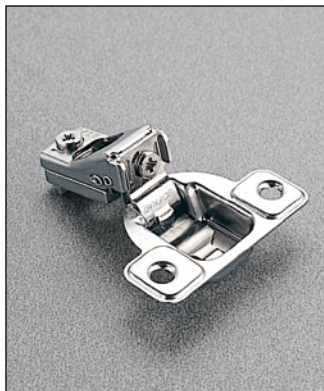

	106° ø35	106° ø35	106° ø35	106° ø35	Packaging Emballage
s/c	CSP3Y99	CSP3Z99	CSP3999	CSP3899	300
s/c	CSR3Y99	CSR3Z99	CSR3999	CSR3899	300
Suggested frame fixing screw # 10 x 3/4" RHP. Vis de fixation recommandée pour cadre # 10 x 3/4" RHP.					



s/c	CSP3799	CSP3699	CSP3599	CSP3499	300
s/c	CSR3799	CSR3699	CSR3599	CSR3499	300
Zero-door protrusion - Suggested frame fixing screw # 10 x 3/4" RHP. Sans recul de la porte - Vis de fixation recommandée pour cadre # 10 x 3/4" RHP.					



s/c	CSP3299N	CSP3199N	CSP3A99N	CSP3B99N	300
s/c	CSR3299N	CSR3199N	CSR3A99N	CSR3B99N	300
Zero-door protrusion - Suggested frame fixing screw # 10 x 1" RHP. Sans recul de la porte - Vis de fixation recommandée pour cadre # 10 x 1" RHP.					

s/c	CSP3C99N	CSP3D99N	CSP3E99N		300
s/c	CSR3C99N	CSR3D99N	CSR3E99N		300
Zero-door protrusion - Suggested frame fixing screw # 10 x 3/4" RHP. Sans recul de la porte - Vis de fixation recommandée pour cadre # 10 x 3/4" RHP.					

Adjustments Réglages

Zero-door protrusion from $\frac{1}{2}$ " to $1 - \frac{9}{16}$ " overlay.
Sans recul de la porte, recouvrement de $\frac{1}{2}$ " à $1 - \frac{9}{16}$ ".

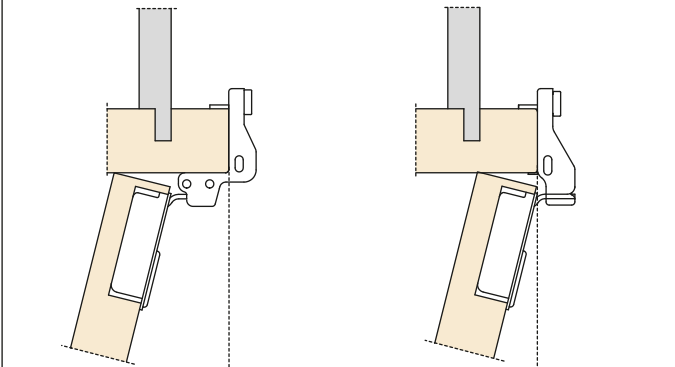

D = required door overlay
T = max. door thickness
K = drilling distance
A = reveal
L = gap between door and frame

- Stamped steel
- Cup depth 11 mm ($\frac{7}{16}$ ")
- Opening 106° degrees
- K fixed at 2.5 mm ($\frac{3}{32}$ ")
- L = 4.6 mm ($\frac{3}{16}$ ")
- **For overlays from $\frac{1}{4}$ " through $\frac{3}{4}$ " the "A" value = 8.3 mm for $\frac{3}{4}$ " square edge doors at 90° opening.**
- **For overlays from 1" through $1 - \frac{7}{16}$ " the "A" value = 5.2 mm for $\frac{3}{4}$ " square edge doors at 90° opening.**

Frame cabinet.
Mobilier avec cadre.

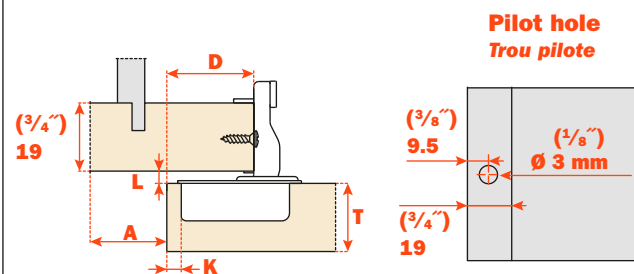

D = recouvrement désiré
T = épaisseur max. de la porte
K = distance de perçage
A = jeu
L = distance entre la porte et le cadre

- Acier moulé
- Profondeur du boîtier 11 mm ($\frac{7}{16}$ ")
- Ouverture à 106°
- K fixé à 2,5 mm ($\frac{3}{32}$ ")
- L = 4.6 mm ($\frac{3}{16}$ ")
- **Pour les recouvrements de $\frac{1}{4}$ " à $\frac{3}{4}$ " , la valeur « A » = 8.3 mm pour les portes à bord carré de $\frac{3}{4}$ " à 90° d'ouverture.**
- **Pour les recouvrements de 1" à $1 - \frac{7}{16}$ " , la valeur "A" = 5.2 mm pour les portes à bord carré de $\frac{3}{4}$ " à 90° d'ouverture.**

Height adjustment ± 2 mm ($\pm \frac{3}{32}$ ")

Réglage vertical ± 2 mm ($\pm \frac{3}{32}$ ")

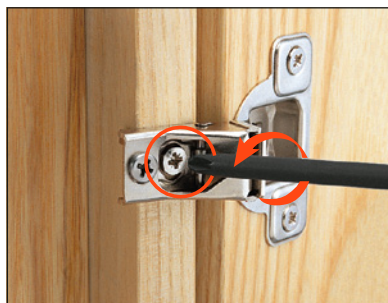
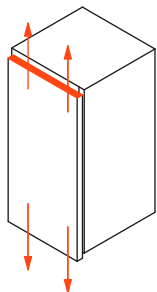

Depth adjustment by eccentric cam
 $+2.5$ mm ($+\frac{7}{64}$ "), -0.5 mm ($-\frac{1}{64}$ ")

Réglage frontal par vis excentrique
 $+2.5$ mm ($+\frac{7}{64}$ "), -0.5 mm ($-\frac{1}{64}$ ")

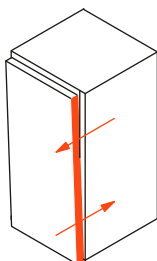

Side adjustment by eccentric cam for hinges:

- CS_3Y99; CS_3Z99; CS_3999; CS_3899; CS_3799; CS_3699;
CS_3599; CS_3499,
+2.8 mm, -1.5 mm ($+\frac{7}{64}$ " , $-\frac{1}{16}$ ")

- CS_3299N; CS_3199N; CS_3A99N; CS_3B99N; CS_3C99N;
CS_3D99N; CS_3E99N;
+3 mm, -2 mm ($+\frac{1}{8}$ " , $-\frac{5}{64}$ ")

Réglage latéral par vis excentrique pour charnières:

- CS_3Y99; CS_3Z99; CS_3999; CS_3899; CS_3799; CS_3699;
CS_3599; CS_3499,
+2.8 mm, -1.5 mm ($+\frac{7}{64}$ " , $-\frac{1}{16}$ ")

- CS_3299N; CS_3199N; CS_3A99N; CS_3B99N; CS_3C99N;
CS_3D99N; CS_3E99N;
+3 mm, -2 mm ($+\frac{1}{8}$ " , $-\frac{5}{64}$ ")

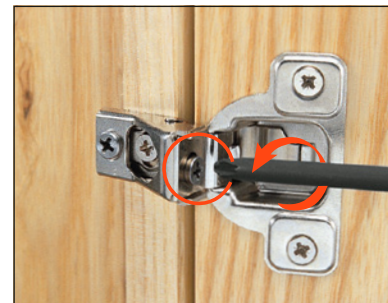
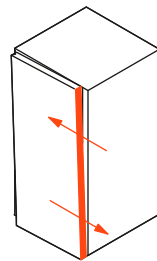

S series **ecen three** **3 cam adjustable**
Serie S **3 vis excentriques réglables**

	106° ø35	106° ø35	106° ø35	106° ø35	Packaging Emballage

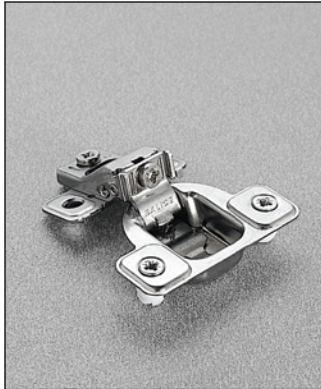

s/c	CSP3799XR	CSP3699XR	CSP3599XR	CSP3499XR	300
s/c	CSR3799XR	CSR3699XR	CSR3599XR	CSR3499XR	300
Zero-door protrusion - Suggested frame fixing, screw # 6 x 5/8" FHP. Sans recul de la porte - Vis de fixation recommandée pour cadre # 6 x 5/8" FHP.					



s/c	CSP3299NR	CSP3A99NR	CSP3B99NR	CSP3C99NR	300
s/c	CSR3299NR	CSR3A99NR	CSR3B99NR	CSR3C99NR	300
Zero-door protrusion - Suggested frame fixing, screw # 6 x 5/8" FHP. Sans recul de la porte - Vis de fixation recommandée pour cadre # 6 x 5/8" FHP.					

Ideal for refacing and other applications where frame thickness varies. Hinge is indexed from the front of the face frame only. There is no back tab.

Idéal pour les rénovations et autres applications où l'épaisseur du cadre varie. La charnière est insérée uniquement dans la partie avant du cadre. Pas de butée arrière.

s/c	CSP3D99NR	CSP3E99NR			300
s/c	CSR3D99NR	CSR3E99NR			300
Zero-Door Protrusion - Suggested frame fixing, screw # 6 x 5/8" FHP. Sans recul de la porte - Vis de fixation recommandée pour cadre # 6 x 5/8" FHP.					

Adjustment Réglages

Zero-door protrusion from $\frac{1}{2}$ " to $1 - \frac{9}{16}$ " overlay
 Sans recul de la porte, recouvrement de $\frac{1}{2}$ " à $1 - \frac{9}{16}$ "

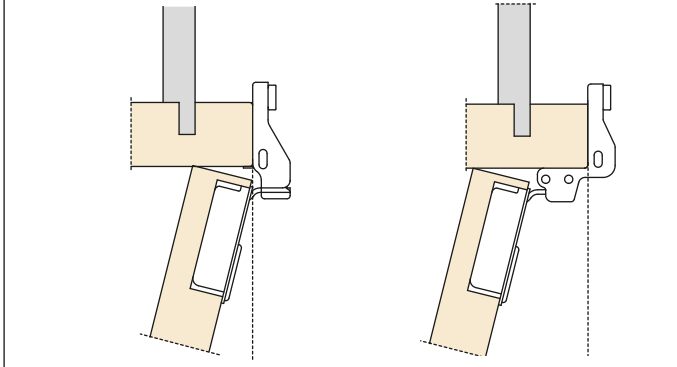

- D** = required door overlay
- T** = max. door thickness
- K** = drilling distance
- A** = reveal
- L** = gap between door and frame

- Stamped steel
- Cup depth 11 mm ($\frac{7}{16}$ ")
- Opening 106°
- K fixed at 2.5 mm ($\frac{3}{32}$ ")
- L = 4.6 mm ($\frac{3}{16}$ ")

- **For overlays from $\frac{1}{2}$ " through $\frac{3}{4}$ " the "A" value = 8.3 mm for $\frac{3}{4}$ " square edge doors at 90° opening.**
- **For overlays from 1" through $1 - \frac{7}{16}$ " the "A" value = 5.2 mm for $\frac{3}{4}$ " square edge doors at 90° opening.**

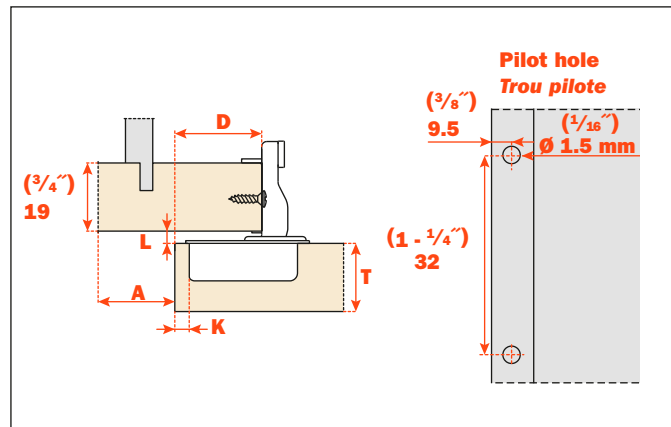

- D** = recouvrement désiré
- T** = épaisseur max. de la porte
- K** = distance de perçage
- A** = jeu
- L** = distance entre la porte et le cadre

- Acier moulé
- Profondeur du boîtier 11 mm ($\frac{7}{16}$ ")
- Ouverture à 106°
- K fixé à 2,5 mm ($\frac{3}{32}$ ")
- L = 4.6 mm ($\frac{3}{16}$ ")

- **Pour les recouvrements de $\frac{1}{2}$ " à $\frac{3}{4}$ " , la valeur "A" = 8.3 mm pour les portes à bord carré de $\frac{3}{4}$ " à 90° d'ouverture.**
- **Pour les recouvrements de 1" à $1 - \frac{7}{16}$ " , la valeur "A" = 5.2 mm pour les portes à bord carré de $\frac{3}{4}$ " à 90° d'ouverture.**

Height adjustment by eccentric cam **± 2 mm ($\pm \frac{3}{32}$ ")**
 Réglage vertical par vis excentrique **± 2 mm ($\pm \frac{3}{32}$ ")**

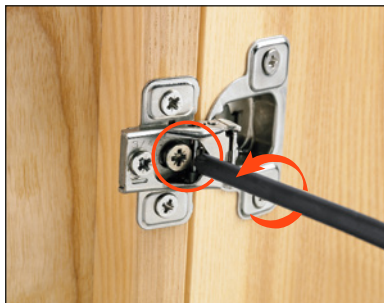
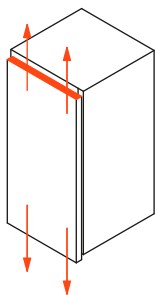

Depth adjustment by eccentric cam **-0.5 mm ($-\frac{1}{64}$ ") + 2.5 mm ($+\frac{7}{64}$ ")**
 Réglage frontal par vis excentrique **-0.5 mm ($-\frac{1}{64}$ ") + 2.5 mm ($+\frac{7}{64}$ ")**

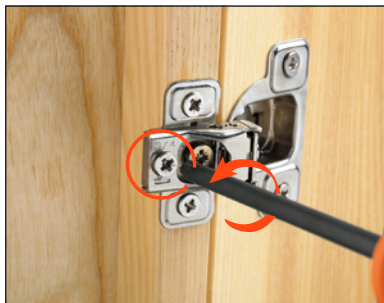
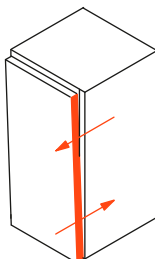

Side adjustment by eccentric cam for hinges:

- CS_3799XR; CS_3699XR; CS_3599XR; CS_3499XR, **+2.8 mm, -1.5 mm ($+\frac{7}{64}$ " , $-\frac{1}{16}$ ")**
- CS_3299NR; CS_3A99NR; CS_3B99NR; CS_3C99NR; CS_3D99NR; CS_3E99NR;
- **+3 mm, -2 mm ($+\frac{1}{8}$ " , $-\frac{5}{64}$ ")**

Réglage latéral par vis excentrique pour charnières:

- CS_3799XR; CS_3699XR; CS_3599XR; CS_3499XR, **+2.8 mm, -1.5 mm ($+\frac{7}{64}$ " , $-\frac{1}{16}$ ")**
- CS_3299NR; CS_3A99NR; CS_3B99NR; CS_3C99NR; CS_3D99NR; CS_3E99NR;
- **+3 mm, -2 mm ($+\frac{1}{8}$ " , $-\frac{5}{64}$ ")**

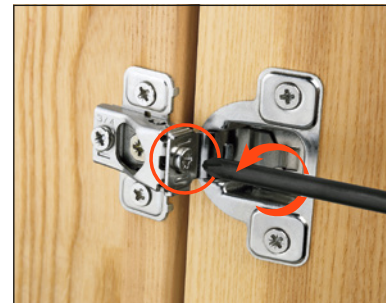
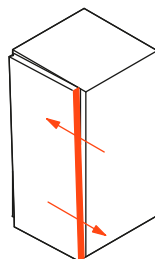

Accessories Accessoires

S2BX83H9



Steel symmetrical screw cover cap with or without printed logo.
For all 100, 200 and F hinges.
5.000 pcs/box.
Minimum order for personalized cover cap is 10.000 pcs.
Excluded: 165° and 155° opening hinges.

Cache-vis symétrique en acier avec ou sans logo imprimé.
Pour les charnières Série 100, 200 et F.
5.000 pièces/carton.
Commande minimum pour un cache-vis avec personnalisation: 10.000 pièces.
Exclus : charnières à ouverture 165° et 155°.

S2MX83H9



Steel symmetrical screw cover cap with embossed logo.
For all 100, 200 and F hinges.
5.000 pcs/box.
Minimum order for personalized cover cap is 100.000 pcs.
Excluded: 165° and 155° opening hinges.

Cache-vis symétrique en acier avec logo gravé.
Pour les charnières Série 100, 200 et F.
5.000 pièces/carton.
Commande minimum pour un cache-vis avec personnalisation: 100.000 pièces.
Exclus : charnières à ouverture 165° et 155°.

S2XX83A1



Nylon symmetrical screw cover cap with or without printed logo.
For all 100, 200 and F hinges.
Available in white, gray and black. 5.000 pcs/box.
Minimum order for personalized cover cap is 10.000 pcs. Excluded: 165° and 155° opening hinges.

Cache-vis symétrique en nylon avec ou sans logo imprimé.
Pour les charnières Série 100, 200 et F.
Disponible en blanc, gris et noir.
5.000 pièces/carton.
Commande minimum pour un cache-vis avec personnalisation: 10.000 pièces.
Exclus : charnières à ouverture 165° et 155°.

SSXX83



Nylon asymmetrical screw cover cap with or without printed logo.
For all S series hinges. Available in beige and gray. 5.000 pcs/box.
Minimum order for personalized cover cap is 10.000 pcs.
For further information please consult our technical support department.

Cache-vis asymétrique en nylon avec ou sans logo imprimé.
Pour les charnières Série S.
Disponible en beige et gris.
5.000 pièces/carton.
Commande minimum pour un cache-vis avec personnalisation: 10.000 pièces.
Pour toutes les explications, veuillez consulter notre service d'assistance technique.

Steel Flange Cache-boîtier en acier



S2XX85H9
Steel flange cover cap, it can be personalized on request.

S2XX85H9
Cache-boîtier en acier.
Personnalisation (logo) sur demande.

S2CX85H9
Steel flange cover cap with embossed logo.

S2CX85H9
Cache-boîtier en acier avec logo gravé.

S2AF37X3



Reduction clip for 165° hinges:
limits opening to 125°.
Reduction clip for 155° hinges:
limits opening to 125°.
Black.

*Arrêt pour les charnières à
165°, pour limiter l'ouverture
à 125°.
Arrêt pour les charnières à
155°, pour limiter l'ouverture
à 125°.
Noir*



SBA237XG

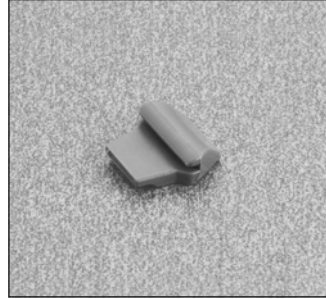

Reduction clip for Universal
hinges: limits opening to 90°

Arrêt à 90° pour toutes les
charnières Universelles.



S2BF37XY

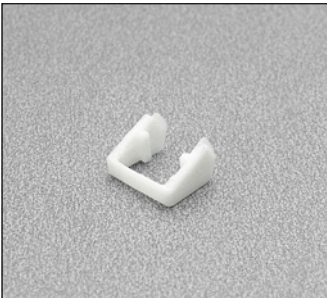

Reduction clip for 165° hinges:
limits opening to 110°.
Reduction clip for 155° hinges:
limits opening to 110°.
White.

*Arrêt pour les charnières à 165°,
pour limiter l'ouverture à 110°.
Arrêt pour les charnières à 155°,
pour limiter l'ouverture à 110°.
Blanc*



S2A637XF

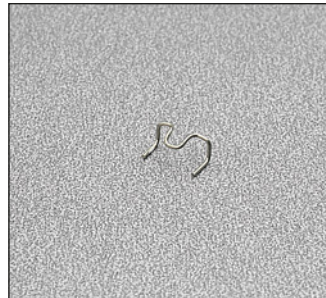

Reduction clip for all hinges with
94° opening and 35 mm cup only.
Limits opening to 86°.

500 pcs/box.

*Arrêt à 86° pour toutes les
charnières à 94° avec boîtier
ø 35 mm.
500 pièces/carton.*

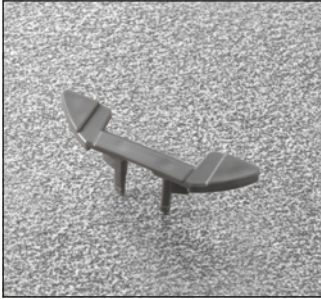

**Accessories
Accessoires****SSP3377G**

Reduction clip for partial overlay
S series hinges from 1/4" - 3/4".
Limits opening to 86°.

*Arrêt à 86° pour les charnières
Série S, recouvrement
partiel, de 1/4" - 3/4".*

**SSP337AG**

Reduction clip for full overlay
S series hinges from 1-1/8" -
1-9/16".
Limits opening to 86°.

*Arrêt à 86° pour les charnières
Série S, recouvrement
partiel, de 1-1/8" - 1-9/16".*

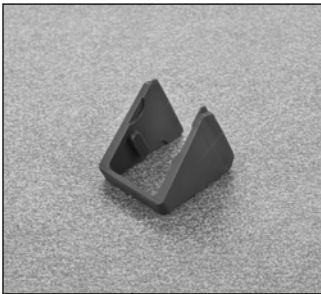
**S2BM37XG**

For 155° hinges,
it limits opening to 92°.

*Pour limiter l'ouverture à 92°
pour les charnières à 155°.*

**S2AM37XG**

For 155° hinges,
it limits opening to 120°.

*Pour limiter l'ouverture à 120°
pour les charnières à 155°.*

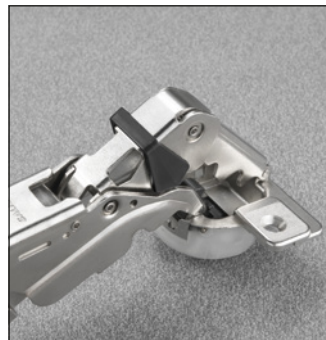



Push - self opening hinge system

Push - système de charnières à ouverture automatique

Push

Push - Self opening door system allows for easy and complete opening of cabinet and furniture doors by lightly pressing on the door itself. Manufacturers will be able to implement the use of Push into the design of contemporary units free of decorative hardware.

Push - Le système pour l'ouverture automatique de toutes sortes de meubles sans poignée, en appuyant légèrement sur la porte. Les fabricants pourront mettre en oeuvre l'utilisation de Push dans la conception d'unités contemporaines sans quincaillerie décorative



The Push system is composed of three components cooperating to swing the door open automatically:

- 1) Multiple self opening hinges**
- 2) One latch**
- 3) One catch**

Le système Push est composé de trois composants pour ouvrir la porte automatiquement:

- 1) Charnières avec poussée en ouverture**
- 2) Un loqueteau**
- 3) Un gâche**

To select the correct number of hinges please refer to the chart on page 4 of this catalog.

Pour sélectionner le nombre correct de charnières, veuillez-vous reporter au tableau de la page 4 de ce catalogue.

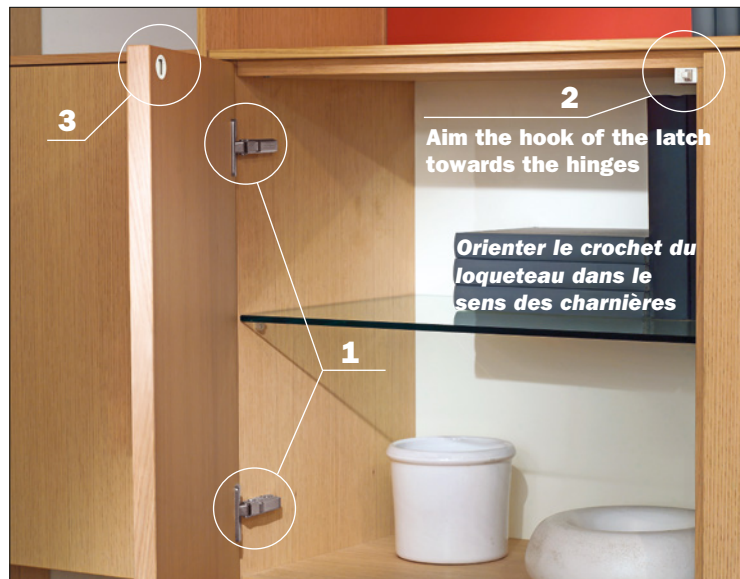

“PUSH has been designed to function without the need of finger pulls (i.e. back bevel doors, routed finger pulls, etc.) and decorative hardware such as pulls, knobs, etc. Forcing the door open could damage the push mechanism.”

“PUSH a été projeté pour l'ouverture de toutes sortes de meubles sans poignées, boutons ou autres accessoires décoratifs (dans les portes moulées ou avec biseaux de tous les côtés). Forcer la porte pourrait endommager le mécanisme Push”.



DP3SNB - beige - beige

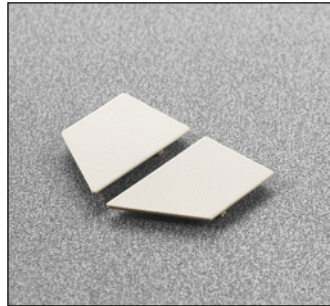
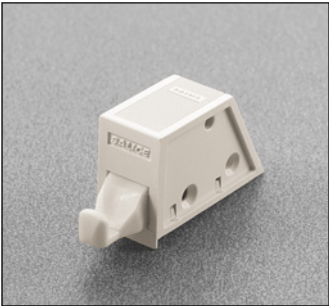

**PUSH - for woodscrew fixing.
With assembly stop tabs.**

*PUSH - fixation avec vis à bois
Avec butée.*

**Packing - 300
Emballage - 300**

DP3SNG - gray - gris

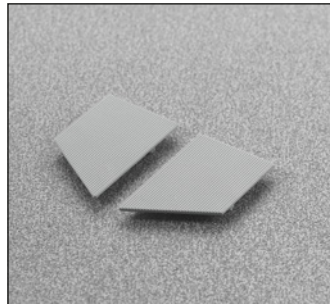
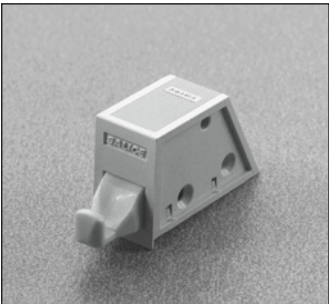

**PUSH - for woodscrew fixing.
With assembly stop tabs.**

*PUSH - fixation avec vis à bois
Avec butée.*

**Packing - 300
Emballage - 300**

DP3SN3 - black - noir

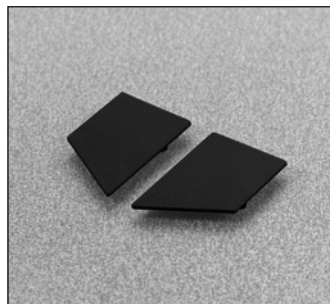
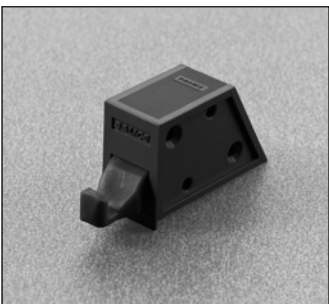

**PUSH - for woodscrew fixing.
With assembly stop tabs.**

*PUSH - fixation avec vis à bois
Avec butée.*

**Packing - 300
Emballage - 300**

DP29SNB - beige - beige



DP29SNG - gray - gris

DP29SN3 - black - noir

**Retaining catch for wood door.
For overlay applications.**

Knock-in.
Requires 26 mm hole.

**Gâche pour porte en bois.
Pour porte en applique.**

A pression.
Perçage 26 mm.

**Packing - 300
Emballage - 300**

DP29SNBR - beige - beige



DP29SNGR - gray - gris

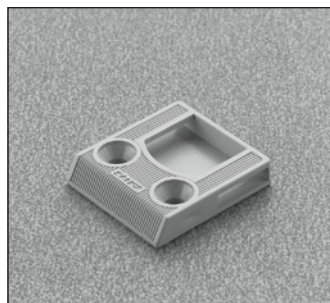

DP29SN3R - black - noir

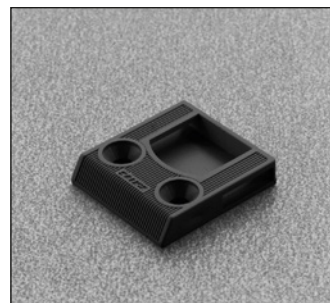

**Retaining catch for wood door.
For inset applications.**

Without assembly stop tabs.
Screw-on.

**Gâche pour porte en bois.
Pour porte rentrante**

Sans butée.
A visser.

**Packing - 300
Emballage - 300**

Push

DP4SNB - beige - beige

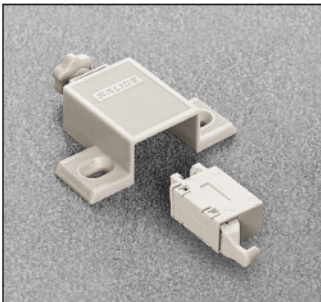

DP4SNG - gray - gris

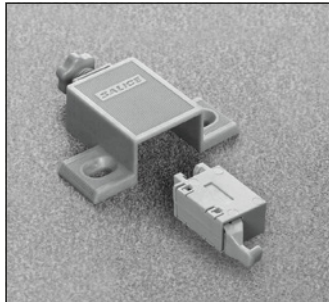

DP4SN3 - black - noir

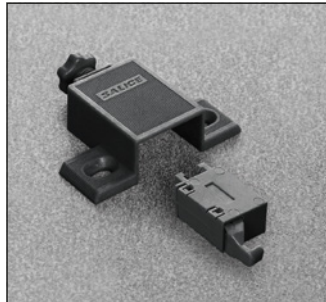

PUSH with adjustment

Single adapter with lateral and depth adjustment including release device (latch). Without assembly stop tabs.

PUSH avec réglage

Adaptateur simple avec réglage frontal et latéral et loqueteau. Sans butée.

Packing - 300
Emballage - 300

DP5SNB - beige - beige

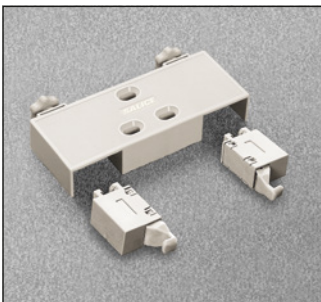

DP5SNG - gray - gris

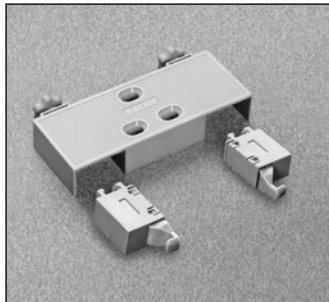

DP5SN3 - black - noir

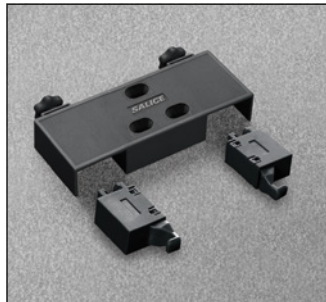

PUSH with adjustment

Double adapter with lateral and depth adjustment including release device (latch). Without assembly stop tabs.

PUSH avec réglage

Adaptateur double avec réglage frontal et latéral et loqueteaux. Sans butée.

Packing - 150
Emballage - 150



Technical information on the adjustable Push

The adjustable Push consists of a release device (latch) and a screw-fixed adapter which has been developed to improve the locating action of the system. It now has a depth adjustment series of -1 mm to + 2.5 mm which is controlled by a small adjuster screw located at the back of the adapter. In addition, the adapter has a lateral adjustment of ± 2 mm series. This is achieved by loosening the two fixing screws and adjusting the position of the adapter using the elongated holes. Finally, the screws must be retightened.

Caractéristiques techniques Push mécanique avec réglage.

Le PUSH avec réglage, composé d'un loqueteau et d'un adaptateur à visser, a été développé pour résoudre les problèmes d'accrochage entre le loqueteau et gâches (monté sur la porte). Il est possible d'effectuer un réglage frontal de -1 à 2.5 mm en agissant sur la molette de l'adaptateur. En dévissant les deux vis de fixation, il est possible de régler latéralement le Push de ± 2 mm. Les trous ovales permettent le glissement de l'adaptateur dans les deux sens. Une fois l'opération terminée, les vis doivent être resserrées.

PUSH Insertion tool for retaining catch.

Salice America offers a 26 mm drill bit - TDB5726R.

PUSH Outil pour gâche

Salice America offre un foret de 26 mm - TDB5726R.

DP50SNO



Oseries insertion tool for aligning the retaining catch DP29SNX.

Outil orange pour régler la position de gâches DP29SNX.

Drilling for wood doors
Perçage pour portes en bois



Full-overlay door
Porte en applique

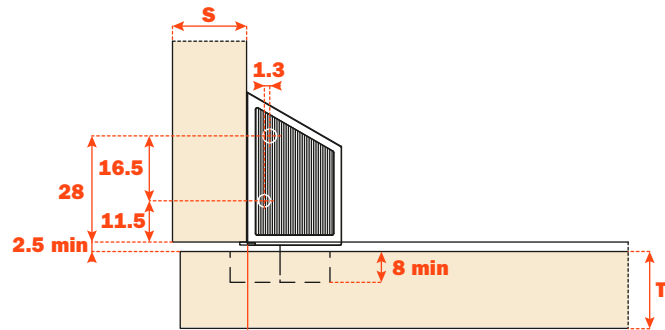
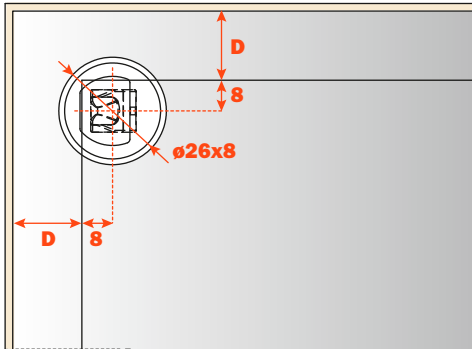

D = Door overlay on side and top of the cabinet
Drilling distance to the center of retaining catch = D + 8

D = Recouvrement de la porte sur le côté et le chapeau haut du meuble
Distance de perçage de gâches = D + 8

Inset door
Porte rentrante

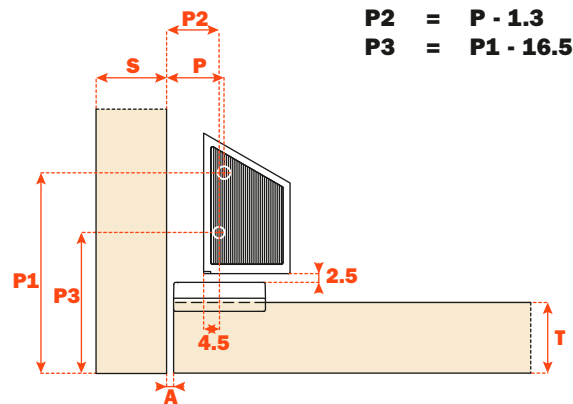
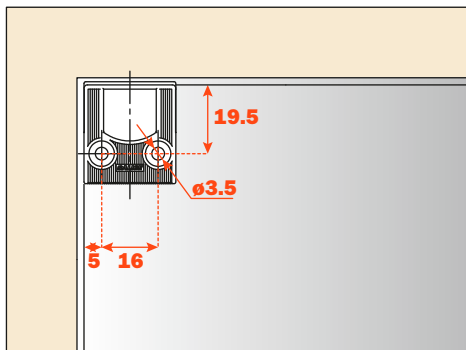

$$\begin{aligned}
 P &= 14.8 + A \\
 P1 &= 36.8 + T \\
 P2 &= P - 1.3 \\
 P3 &= P1 - 16.5
 \end{aligned}$$

Salice America offers 4.8 mm spacer (left and right) for special inset doors applications; refer to our master catalog for descriptions, item numbers and packaging.

Salice America offre une cache de 4,8 mm (gauche et droite) pour les applications spéciales avec porte rentrante; voir notre catalogue général pour les descriptions, les codes et les emballages.

Push • With adjustment

Push • Avec réglage

Push with depth and lateral adjustment

Push avec réglage frontal et latéral

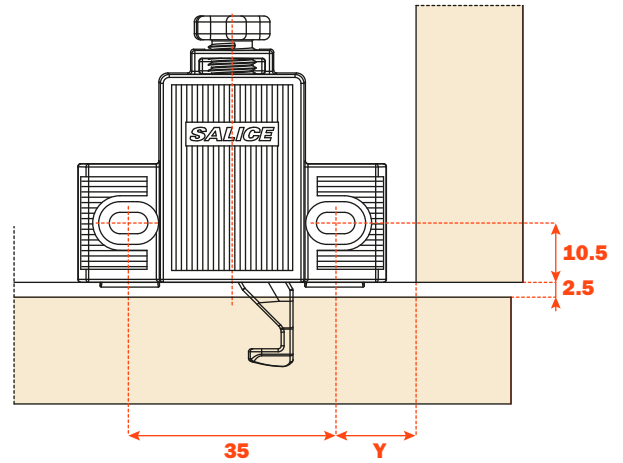
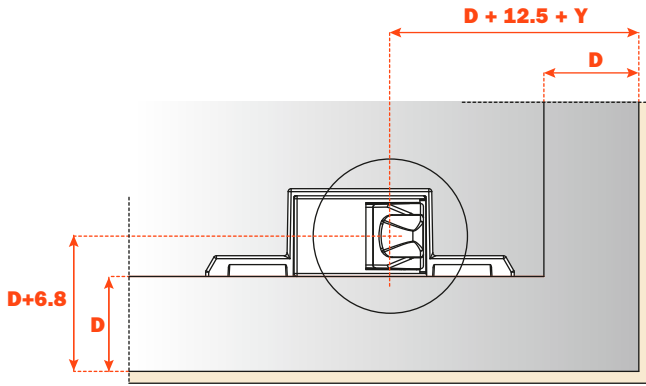

D = Door overlay on side and top of the cabinet
Y = min. 8.5 mm

D = Recouvrement de la porte sur le côté et le chapeau haut du meuble
Y = min. 8.5 mm

Double Push with depth and lateral adjustment

Push double avec réglage frontal et latéral

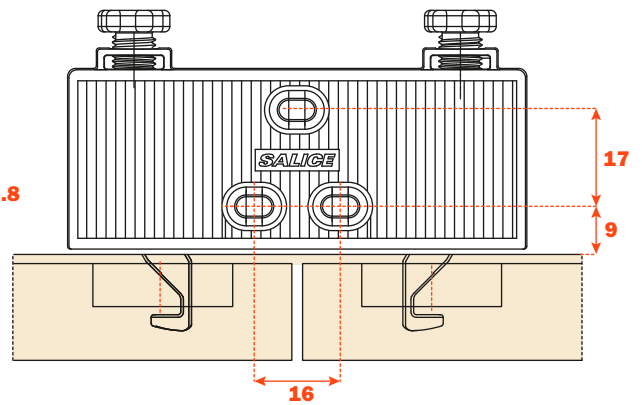
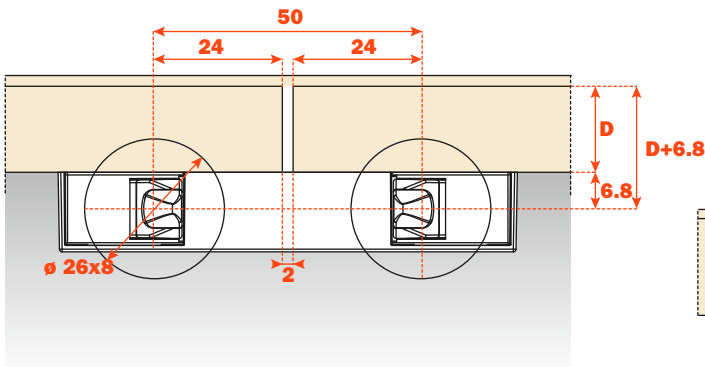

Magnetic release device
Loqueteau magnétique



DPMSNB



Release device.
ø 10 mm, 40 mm length.

Loqueteau.
ø 10 mm, longueur 40 mm.

Packing - 250

Emballage - 250

DPASNB



Magnetic device to be used to increase the magnetic holding strength. It must always be used together with the DPM. The suggested position of the DPM is the point of pressure on the door. The DPA can be positioned at any point along the opening edge of the door. ø 10 mm, 40 mm length.

Crochet magnétique à utiliser pour augmenter la force de retenue. Il doit être toujours utilisé en combinaison avec le DPM. La position conseillée du DPM est en correspondance avec le point de pression sur la porte. Celle du DPA est indifférente. 10 mm, longueur 40 mm.

Packing - 250

Emballage - 250

DP28SN9



Retaining catch to be inserted.
ø 11.5 mm.

Gâches à enfoncer.
ø 11.5 mm.

Packing - 250

Emballage - 250

DP38XX91



Retaining catch with adhesive.
20x14 mm.

Gâches avec adhésif.
20x14 mm

Packing - 250

Emballage - 250

DP39XXG

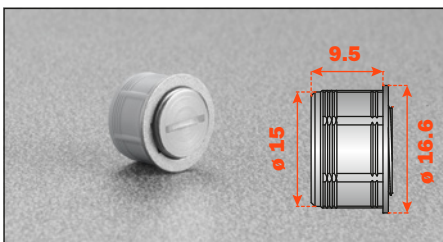

Adjustable magnetic retaining catch.
ø16.6 mm

Platine magnétique réglable.
ø16.6 mm

Packing - 250

Emballage - 250

SP44XX_

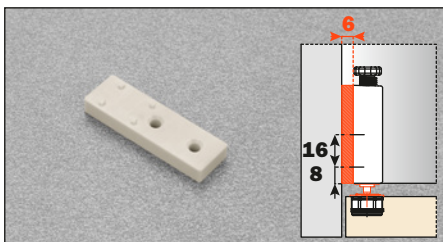

Spacer for inset door to be used together with DP82XX_R.

Cache pour porte rentrante en combinaison avec DP82XX_R.

SP44XXB = Beige
SP44XX3 = Black
SP44XXG = Grey

SP44XXB = Beige
SP44XX3 = Noir
SP44XXG = Gris

Packing - 500

Emballage - 500

Push • Adapters

Push • Adaptateurs

DP82XXBR



Adjustable longitudinal plastic adapter for release device. To be fixed with woodscrews. 8+16 mm drilling.

Screw cover to be ordered separately.
 DP82xxBR = beige DP82xxQR = brown*
 DP82xxGR = gray* DP82xx3R = black

*Brown and gray are non stock and are special order.

Note: The cover cap shown in the picture has to be ordered separately

Packing - 500

Adaptateur longitudinal réglable, en plastique, pour loqueteau. Fixation avec vis à bois.

Perçage 8+16 mm.

Cache à commander à part.

DP83xxBR = beige DP83xxQR = marron
 DP83xxGR = gris* DP83xx3R = noir*

**Marron et gris ne sont pas en stock et sont commandes spéciales.*

Note: la cache sur l'adaptateur dans la photo doit être commandé séparément

Emballage - 500

DP83XXBR

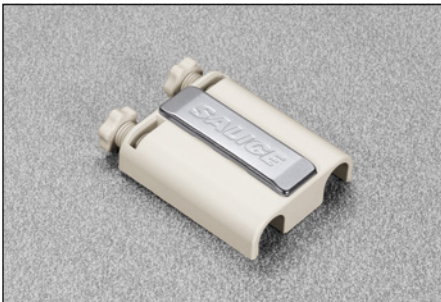

Adjustable double plastic adapter for release device.

To be fixed with woodscrews.

8+32 mm drilling.

Screw cover to be ordered separately.
 DP83xxBR = beige DP83xxQR = brown*
 DP83xxGR = gray* DP83xx3R = black

*Brown and gray are non stock and are special order.

Note: The cover cap shown in the picture has to be ordered separately

Packing - 500

Adaptateur double réglable, en plastique, pour loqueteau. Fixation avec vis à bois.

Perçage 8+32 mm.

Cache à commander à part.

DP83xxBR = beige DP83xxQR = marron
 DP83xxGR = gris* DP83xx3R = noir*

**Marron et gris ne sont pas en stock et sont commandes spéciales.*

Note: la cache sur l'adaptateur dans la photo doit être commandé séparément

Emballage - 500

DP84SNBR

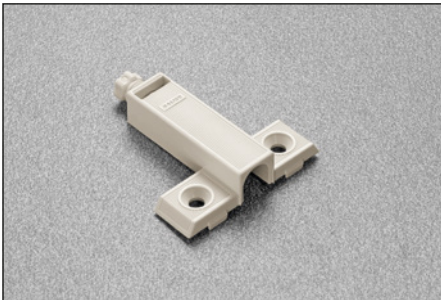

Adjustable plastic adapter for release device.

To be fixed with woodscrews.

With assembly stop tabs.

8x32 mm drilling.

DP84xxBR = beige DP84xxQR = brown*
 DP84xxGR = gray* DP84xx3R = black

Adaptateur réglable, en plastique, pour loqueteau. Fixation avec vis à bois.

Avec butées.

Perçage 8x32 mm.

DP84xxBR = beige DP84xxQR = marron
 DP84xxGR = gris* DP84xx3R = noir*

Packing - 500

Emballage - 500

Release device application

Application du loqueteau



Release device application with adapter (DP82xxBR) without assembly stop devices.

Insert the release device frontally into the adapter.
Place the adapter to the top, the side or the base panel of the cabinet, using the drilling value of 8+16 mm for final positioning.

*Release device application with spacer for inset door (DP82SN_R + SP44XX_).

For inset door it is essential to use the spacer SP44XX_.

Application du loqueteau avec adaptateur (DP82xxBR) sans butées.

Insérer frontalement le loqueteau dans l'adaptateur. Fixer l'adaptateur sur le chapeau haut, le côté ou la base du meuble, en considérant, pour le positionnement correct, la valeur d'entraxe 8+16 mm.

Application du loqueteau avec cache pour porte rentrante (DP82SN_R + SP44XX_).

Pour porte rentrante il est nécessaire d'ajouter le cache SP44XX_.

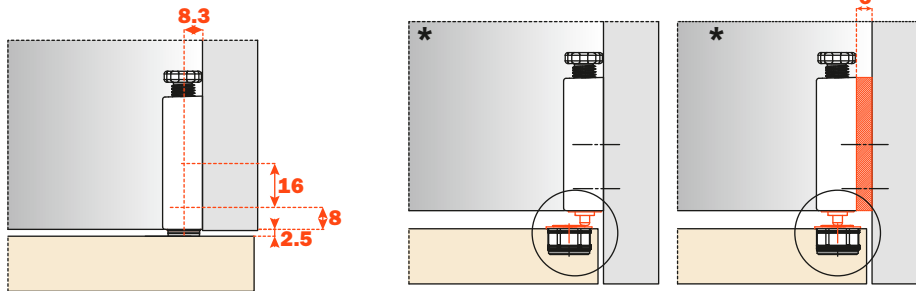

Release device application with adapter (DP83xxBR) without assembly stop devices.

Insert the release device into the adapter.
Attach the adapter to the top, the side or the base panel of the cabinet, using the drilling value of 8+32 mm for accurate positioning.

Application du loqueteau avec adaptateur (DP83xxBR) sans butées.

Insérer frontalement le loqueteau dans l'adaptateur. Fixer l'adaptateur sur le chapeau haut, le côté ou la base du meuble, en considérant, pour le positionnement correct, la valeur d'entraxe 8+32 mm.

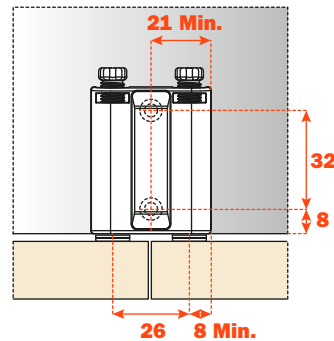

Release device application with adapter (DP84SN_R) with assembly stop devices.

Insert the release device into the adapter.
Attach the adapter to the top, the side or base panel of the cabinet, using the assembly stop devices for accurate positioning.

Application du loqueteau avec adaptateur (DP84SN_R) avec butées.

Insérer le loqueteau dans l'adaptateur. Fixer l'adaptateur sur le chapeau haut, le côté ou la base du meuble, en utilisant les butées pour le positionnement correct.

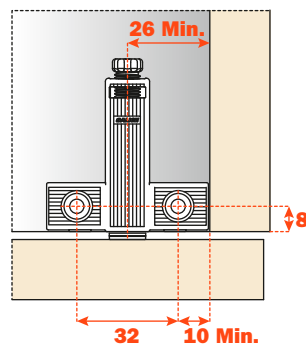

Push • Release device application**Push • Application du loqueteau****Application of the release device to be recessed.**

Drill a hole \varnothing 10 mm and min. 40 mm deep in the top, side or base panel of the cabinet.

Insert the release device into the hole.

Application du loqueteau à encastrer

Percer un trou de 10 mm de diamètre et min. 40 mm de profondeur dans le chapeau, le côté ou la base du meuble. Insérer le loqueteau dans le trou.

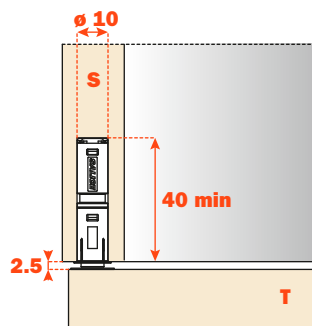



1 - Retaining catch with adhesive.

Apply the retaining catch to the magnetic release device.
Refer to Figure 1 below. Remove the protective covering from the adhesive and center the catch on the release device.
Close the door and apply firm pressure so that the retaining catch will then be correctly positioned on the door.
Reopen the door and again apply pressure to the catch to secure the bond.

Attention:

For a correct application and to insure optimum performance, we suggest that you carefully follow the guidelines listed below.

- 1 - Clean and degrease the door surface where the retaining catch is to be installed.
- 2 - Remove the protective covering from the adhesive
- 3 - Place the retaining catch in position, while in an environment where the temperature is 50° F or above. Apply firm pressure for 10-15 seconds after which the catch is suitable for use. Maximum bond is attained in 24 hrs.

1

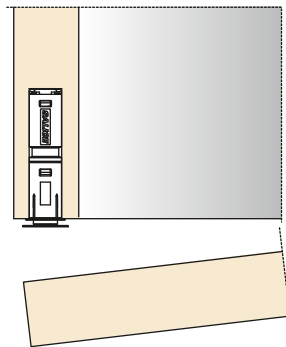

1 - Platine avec adhésif

Appliquer platine au loqueteau magnétique. Reportez-vous à la figure 1 ci-dessous.
Ôter la bande de protection de l'adhésif.
Fermer la porte.
Platine adhésif est ainsi positionné sur la porte.
Rouvrir la porte et appuyer fortement sur platine pour une application correcte.

ATTENTION :

Pour une application correcte et afin d'assurer une meilleure tenue dans le temps, il est conseillé de suivre les instructions suivantes :

- 1 - nettoyer et dégraisser la surface de la porte sur laquelle platine adhésif doit être appliqué;
- 2 - ôter la bande de protection de l'adhésif ;
- 3 - appliquer platine dans un lieu avec température ambiante >10° et appuyer pendant 10 à 15 secondes environ. Quelques secondes après l'application, platine est prêt à l'emploi. Après 24h, on atteint la tenue maximum.

2 - Retaining catch to be inserted.

Apply and center the retaining catch on the magnetic release device.
Refer to Figure 2 below.
Close the door, which in turn, will create an indentation in the door marking the location where the catch is to be inserted.
Using a small hammer, carefully tap in the catch using the indentation as the locating point for positioning. It is then ready for immediate use.

2

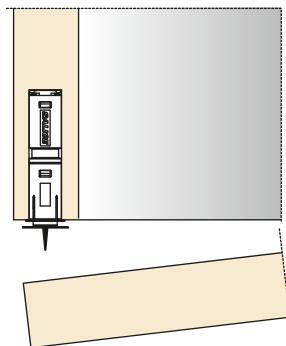

2 - Platine à enfoncer



Appliquer platine au loqueteau magnétique.
Reportez-vous à la figure 2 ci-dessous.
Fermer la porte.
La pointe de platine indiquera l'endroit où l'on doit l'insérer.
Rouvrir la porte et insérer par pression platine.
À l'aide d'un petit marteau, tapotez délicatement dans le loquet en utilisant l'indentation comme point de positionnement .
Il est alors prêt pour une utilisation immédiate.

Push • 200 series hinges • 94° for thick doors

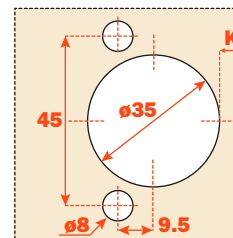

Push • Charnières Série 200 - Pour portes épaisses - Ouverture 94°

	94° ø35	Packaging Emballage
		



PUSH		C2PVA99	100
PUSH		C2RVA99	100



PUSH		C2PVG99	100
PUSH		C2RVG99	100





PUSH		C2PVP99	100
PUSH		C2RVP99	100

200 series hinges - 110°
Charnières Série 200 - 110°



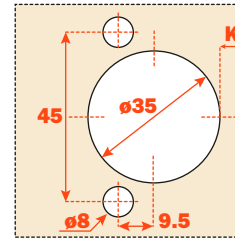

	110° ø35	Packaging Emballage
		





PUSH		C2PPA99	100
PUSH		C2RPA99	100



PUSH		C2PPG99	100
PUSH		C2RPG99	100





PUSH		C2PPP99	100
PUSH		C2RPP99	100

Push • 200 series hinges - 155°

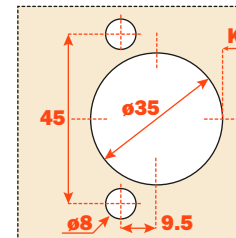

Push • Charnières Série 200 - 155°

	155° ø35	Packaging Emballage
		



PUSH		C2PRA99	100
PUSH		C2RRA99	100



PUSH		C2PRG99	100
PUSH		C2RRG99	100

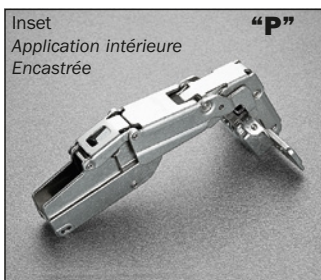



PUSH		C2PRP99	100
PUSH		C2RRP99	100

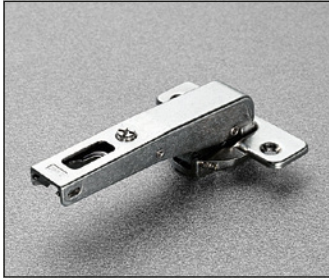
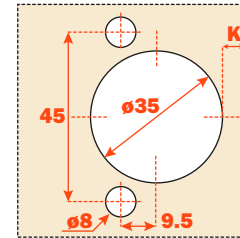

200 series hinges - Complementary hinges
Charnières Série 200 - Charnières complémentaires

	94° ø35	Packaging Emballage
		



PUSH 	C2PVN99AC	150
PUSH 	C2RVN99AC	150



PUSH 	C2PVN99	150
PUSH 	C2RVN99	150

Compatible with all traditional Series 200 mounting plates, 28x32 mm drilling.
NOT COMPATIBLE with Domi snap-on mounting plates.



Adaptables à toutes les embases traditionnelles Série 200, perçage 28x32 mm.
NON ADAPTABLES aux embases Domi à fixation rapide.

B2S3B99B6/15

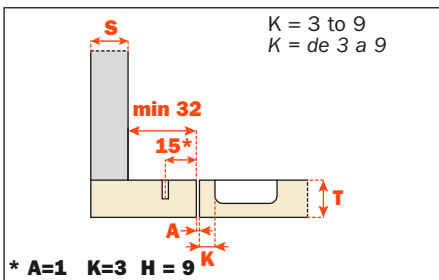

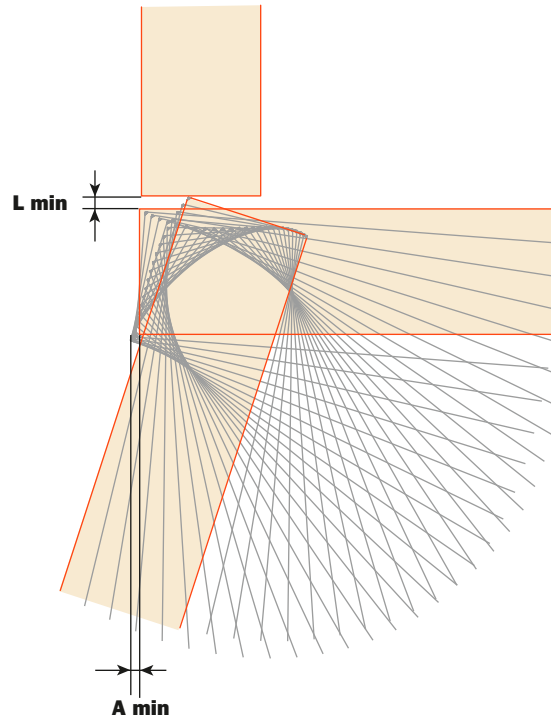

Minimum reveal charts

Tableaux avec jeu nécessaire pour l'ouverture de la porte

Space needed to open the door
Jeu nécessaire pour l'ouverture de la porte

Projection of the door
 Projection of the door from the cabinet side at the maximum opening. The figures are based on a straight arm hinge, H=0 mm thickness of mounting plate and K value = 3 mm.

Recul de la porte
 Recul de la porte par rapport au côté en position d'ouverture maximum (valeur obtenue avec une charnière bras droit, hauteur de l'embase H=0 et valeur K=3)

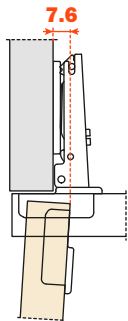

200 series • 94° - for thicker doors
Space needed to open the door

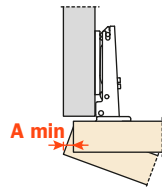

Série 200 • 94° - pour portes épaisses
Jeu nécessaire pour l'ouverture de la porte

	T=	19	20	21	22	23	24	25	26	27	28	29	30	31	32	33	34	35
K=3	A=	0.1	0.2	0.3	0.4	0.5	0.7	0.8	1.0	1.6	2.6	3.5	4.5	5.4	6.4	7.4	8.3	9.3
K=4	A=	0.1	0.2	0.3	0.4	0.5	0.7	0.8	1.0	1.2	1.9	2.8	3.8	4.7	5.7	6.6	7.6	8.6
K=5	A=	0.1	0.2	0.3	0.4	0.5	0.7	0.8	1.0	1.2	1.4	2.2	3.1	4.1	5.0	5.9	6.9	7.8
K=6	A=	0.1	0.2	0.3	0.4	0.5	0.6	0.8	1.0	1.2	1.4	1.7	2.6	3.5	4.4	5.3	6.2	7.2
K=7	A=	0.1	0.2	0.3	0.4	0.5	0.6	0.8	1.0	1.1	1.3	1.6	2.1	3.0	3.8	4.7	5.6	6.5
K=8	A=	0.1	0.2	0.3	0.4	0.5	0.6	0.8	0.9	1.1	1.3	1.6	1.8	2.5	3.3	4.2	5.1	6.0
K=9	A=	0.1	0.2	0.3	0.4	0.5	0.6	0.8	0.9	1.1	1.3	1.5	1.8	2.1	2.9	3.7	4.6	5.4

K=	3	4	5	6	7	8	9
L=	0.0	0.0	0.0	0.0	0.0	0.3	1.3

The above values are calculated on the assumption that the doors have square edges. They are reduced if the doors have radiused edges.

Un rayon adéquat de la porte réduit les valeurs de "A" et de "L".

Projection of the door
 Projection of the door from the cabinet side at the maximum opening. The figures are based on a straight arm hinge, H=0 mm thickness of mounting plate and K value = 3 mm.

Recul de la porte
 Recul de la porte par rapport au côté en position d'ouverture maximum (valeur obtenue avec une charnière bras droit, hauteur de l'embase H=0 et valeur K=3)

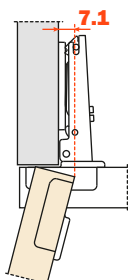

Series 200, 300 and 800 110°
Space needed to open the door

Série 200, 300 et 800 110°
Jeu nécessaire pour l'ouverture de la porte

	T=	16	17	18	19	20	21	22	23	24	25	26
K=3	A=	0.5	0.7	0.9	1.2	1.5	1.8	2.4	3.7	5.1	6.5	7.8
K=4	A=	0.5	0.7	0.9	1.2	1.5	1.8	2.1	2.7	4.1	5.5	6.8
K=5	A=	0.5	0.7	0.9	1.2	1.5	1.8	2.1	2.6	3.1	4.1	5.4
K=6	A=	0.5	0.7	0.9	1.2	1.5	1.8	2.1	2.5	3.0	3.5	4.4

	T=	16	17	18	19	20	21	22	23	24	25	26
K=3	L=	0.0	0.0	0.0	0.0	0.2	0.5	0.8	1.1	1.4	1.7	1.9
K=4	L=	0.0	0.0	0.3	0.6	0.9	1.2	1.4	1.7	2.0	2.3	2.6
K=5	L=	1.1	1.3	1.6	1.8	2.1	2.3	2.6	2.9	3.1	3.4	3.6
K=6	L=	2.0	2.3	2.5	2.8	3.1	3.3	3.6	3.8	4.1	4.3	4.6

The above values are calculated on the assumption that the doors have square edges. They are reduced if the doors have radiused edges.

Un rayon adéquat de la porte réduit les valeurs de "A" et de "L".

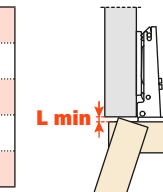
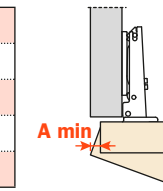
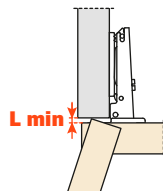

Projection of the door

Projection of the door from the cabinet side at the maximum opening. The figures are based on a straight arm hinge, H=0 mm thickness of mounting plate and K value = 3 mm.

Recul de la porte

Recul de la porte par rapport au côté en position d'ouverture maximum (valeur obtenue avec une charnière bras droit, hauteur de l'embase H=0 et valeur K=3)

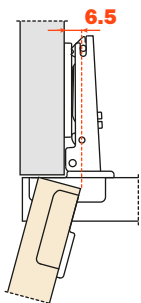

200 series • 120° Space needed to open the door

Série 200 • 120° Jeu nécessaire pour l'ouverture de la porte

	T=	16	17	18	19	20	21	22	23	24	25	26
K=3	A=	1.0	1.3	1.6	1.9	2.2	3.5	5.0	6.5	8.1	9.6	11.2
K=4	A=	1.0	1.3	1.5	1.9	2.2	2.5	4.0	5.5	7.1	8.6	10.2
K=5	A=	1.0	1.2	1.5	1.8	2.1	2.5	3.0	4.5	6.1	7.6	9.2
K=6	A=	1.0	1.2	1.5	1.8	2.1	2.4	2.8	3.5	5.1	6.6	8.1

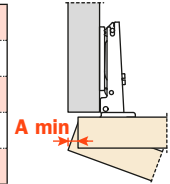

	T=	16	17	18	19	20	21	22	23	24	25	26
K=3	L=	0.0	0.0	0.0	0.0	0.1	0.5	0.9	1.3	1.7	2.1	2.5
K=4	L=	0.0	0.0	0.2	0.6	1.0	1.4	1.8	2.2	2.6	3.1	3.5
K=5	L=	0.3	0.7	1.1	1.5	1.9	2.3	2.8	3.2	3.6	4.0	4.4
K=6	L=	1.2	1.6	2.0	2.4	2.8	3.3	3.7	4.1	4.5	4.9	5.3

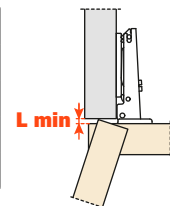

The above values are calculated on the assumption that the doors have square edges. They are reduced if the doors have radiused edges.

Un rayon adéquat de la porte réduit les valeurs de "A" et de "L".

Projection of the door

Projection of the door from the cabinet side at the maximum opening. The figures are based on a straight arm hinge, H=0 mm thickness of mounting plate and K value = 3 mm.

Recul de la porte

Recul de la porte par rapport au côté en position d'ouverture maximum (valeur obtenue avec une charnière bras droit, hauteur de l'embase H=0 et valeur K=3)

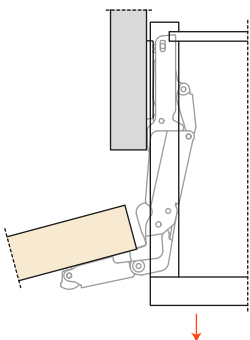

200 series • 165° Space needed to open the door

Série 200 • 165° Jeu nécessaire pour l'ouverture de la porte

	T=	16	18	20	22	24	26	28
K=3	A=	0.0	0.0	0.0	0.7	2.7	4.6	7.9
K=4	A=	0.0	0.0	0.0	0.1	1.8	3.8	6.9
K=5	A=	0.0	0.0	0.0	0.1	1.2	3.0	5.9
K=6	A=	0.0	0.0	0.0	0.1	0.9	2.5	4.9
K=7	A=	0.0	0.0	0.0	0.1	0.7	2.0	3.9
K=8	A=	0.0	0.0	0.0	0.1	0.6	1.7	3.2

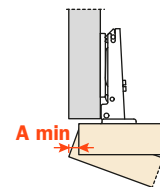

The above values are calculated on the assumption that the doors have square edges. They are reduced if the doors have radiused edges.

Un rayon adéquat de la porte réduit les valeurs de "A" et de "L".

Space needed to open the door Jeu nécessaire pour l'ouverture de la porte

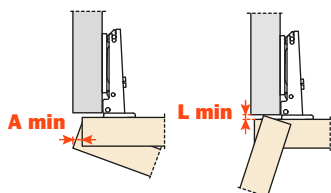

F series • 94° (40 mm ø cup) for THICK DOORS.
Space needed to open the door

Série F • 94° (boîtier ø 40 mm) pour PORTE EPAISSES.
Jeu nécessaire pour l'ouverture de la porte

	T=	20	21	22	23	24	25	26	27	28	29	30	31	32	33	34	35	36	37	38	39	40	L=
K=3	A=	0.4	0.5	0.7	0.8	1.0	1.2	1.4	1.6	1.9	2.2	2.5	2.8	3.1	3.5	4.1	5.0	6.0	6.9	7.8	8.8	9.7	0.0
K=4	A=	0.4	0.5	0.7	0.8	1.0	1.2	1.4	1.6	1.9	2.1	2.4	2.7	3.0	3.4	3.8	4.4	5.3	6.3	7.2	8.1	9.0	0.0
K=5	A=	0.4	0.5	0.6	0.8	1.0	1.2	1.4	1.6	1.8	2.1	2.4	2.7	3.0	3.3	3.7	4.1	4.8	5.7	6.6	7.5	8.4	0.0
K=6	A=	0.4	0.5	0.6	0.8	0.9	1.1	1.3	1.6	1.8	2.1	2.3	2.6	2.9	3.3	3.6	4.0	4.4	5.2	6.0	6.9	7.8	0.0
K=7	A=	0.4	0.5	0.6	0.8	0.9	1.1	1.3	1.5	1.8	2.0	2.3	2.6	2.9	3.2	3.6	3.9	4.3	4.8	5.5	6.4	7.3	0.0
K=8	A=	0.4	0.5	0.6	0.8	0.9	1.1	1.3	1.5	1.7	2.0	2.2	2.5	2.8	3.1	3.5	3.8	4.2	4.7	5.1	5.9	6.8	0.0
K=9	A=	0.4	0.5	0.6	0.7	0.9	1.1	1.3	1.5	1.7	2.0	2.2	2.5	2.8	3.1	3.4	3.8	4.2	4.6	5.0	5.5	6.3	0.0
K=10	A=	0.3	0.5	0.6	0.7	0.9	1.1	1.3	1.5	1.7	1.9	2.2	2.4	2.7	3.0	3.4	3.7	4.1	4.5	4.9	5.4	6.0	0.0
K=11	A=	0.3	0.4	0.6	0.7	0.9	1.0	1.2	1.4	1.7	1.9	2.1	2.4	2.7	3.0	3.3	3.6	4.0	4.4	4.8	5.2	5.7	0.0
K=12	A=	0.3	0.4	0.6	0.7	0.9	1.0	1.2	1.4	1.6	1.9	2.1	2.4	2.6	2.9	3.3	3.6	3.9	4.3	4.7	5.1	5.6	0.4
K=13	A=	0.3	0.4	0.5	0.7	0.9	1.0	1.2	1.4	1.6	1.8	2.1	2.3	2.6	2.9	3.2	3.5	3.8	4.2	4.5	4.9	5.4	1.2
K=14	A=	0.3	0.4	0.5	0.7	0.8	1.0	1.2	1.4	1.6	1.8	2.0	2.3	2.6	2.8	3.2	3.5	3.8	4.2	4.5	4.9	5.4	2.2
K=15	A=	0.3	0.4	0.5	0.7	0.8	1.0	1.2	1.4	1.6	1.8	2.0	2.3	2.6	2.8	3.2	3.5	3.8	4.2	4.5	4.9	5.4	3.2

The above values are calculated on the assumption that the doors have square edges. They are reduced if the doors have radiused edges.

Un rayon adéquat de la porte réduit les valeurs de "A" et de "L".

Projection of the door

Projection of the door from the cabinet side at the maximum opening. The figures are based on a straight arm hinge, H=0 mm thickness of mounting plate and K value = 3 mm.

Recul de la porte

Recul de la porte par rapport au côté en position d'ouverture maximum (valeur obtenue avec une charnière bras droit, hauteur de l'embase H=0 et valeur K=3)

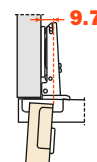

Projection of the door

Projection of the door from the cabinet side at the maximum opening. The figures are based on a straight arm hinge, H=0 mm thickness of mounting plate and K value = 3 mm.

Recul de la porte

Recul de la porte par rapport au côté en position d'ouverture maximum (valeur obtenue avec une charnière bras droit, hauteur de l'embase H=0 et valeur K=3)

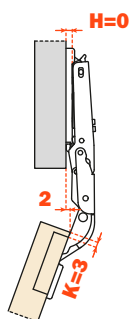

Universal hinges series • 110° Space needed to open the door

	T=	16	18	20	22	24	26
K=3	A=	0.0	0.0	0.0	0.0	0.3	1.4
K=4	A=	0.0	0.0	0.0	0.0	0.4	16.9
K=5	A=	0.0	0.0	0.0	0.0	0.5	15.9
K=6	A=	0.0	0.0	0.0	0.0	0.7	14.9
K=7	A=	0.0	0.0	0.0	0.0	11.3	13.9
K=8	A=	0.0	0.0	0.0	0.0	10.3	12.9
K=9	A=	0.0	0.0	0.0	0.0	9.3	11.9
K=10	A=	0.0	0.0	0.0	6.0	8.3	10.9
K=11	A=	0.0	0.0	0.0	5.1	7.3	9.9
K=12	A=	0.0	0.0	0.0	4.1	6.3	8.9
K=13	A=	0.0	0.0	1.4	3.3	5.3	7.9
K=14	A=	0.0	0.0	0.7	2.6	4.5	6.9
K=15	A=	0.0	0.0	0.2	2.0	3.8	5.9
K=16	A=	0.0	0.0	0.0	1.4	3.2	5.0
K=17	A=	0.0	0.0	0.0	1.0	2.7	4.4
K=18	A=	0.0	0.0	0.0	0.7	2.2	3.9

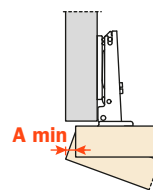

Charnières Universelles • 110° Jeu nécessaire pour l'ouverture de la porte

The above values are calculated on the assumption that the doors have square edges. They are reduced if the doors have radiused edges.

Un rayon adéquat de la porte réduit les valeurs de "A" et de "L".

**200 series • Special H Series
155° wide angle hinges series.**

**Série 200 • Série spéciale H
155° grand angle**

	T=	27	28	29	30	31	32	33	34	35	36
K=3	A=	0.0	0.0	0.2	0.6	0.8	1.0	1.4	1.9	2.3	3.0
K=4	A=	0.0	0.0	0.2	0.6	0.8	1.0	1.4	1.9	2.3	3.0
K=5	A=	0.0	0.0	0.2	0.6	0.8	1.1	1.5	1.9	2.5	3.2
K=6	A=	0.0	0.0	0.2	0.6	0.8	1.2	1.6	1.9	2.5	3.8
K=7	A=	0.0	0.0	0.2	0.6	0.8	1.3	1.7	2.1	2.7	3.9
K=8	A=	0.0	0.0	0.2	0.6	0.8	1.4	1.7	2.1	2.7	4.0
K=9	A=	0.0	0.0	0.2	0.6	0.8	1.4	1.7	2.1	3.0	4.0

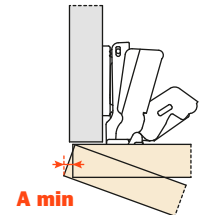

The above values are calculated on the assumption that the doors have square edges. They are reduced if the doors have radiused edges.

Un rayon adéquat de la porte réduit les valeurs de "A" et de "L".

**200 series • K Series, Zero protrusion,
Wide angle hinge series.**

**Série 200 • Série K, sans recul de la porte
Grand angle**

	T=	16	18	20	22	24	25	26	27	28
K=3	A=	0.0	0.0	0.0	0.0	0.0	0.10	0.40	0.75	1.20
K=4	A=	0.0	0.0	0.0	0.0	0.0	0.15	0.45	0.85	1.35
K=5	A=	0.0	0.0	0.0	0.0	0.0	0.20	0.50	0.95	120° 1.70
K=6	A=	0.0	0.0	0.0	0.0	0.0	0.25	0.60	1.10	120° 1.95
K=7	A=	0.0	0.0	0.0	0.0	0.0	0.30	0.70	1.30	100° 2.30
K=8	A=	0.0	0.0	0.0	0.0	0.0	0.35	0.85	120° 1.70	100° 2.80
K=9	A=	0.0	0.0	0.0	0.0	0.15	0.55	1.20	100° 2.15	92° 3.90

**With stop device at 100° item S2BM37XG
Avec arrêt pour limiter l'ouverture à 100° article S2BM37XG**

**With stop device at 120° item S2AM37XG
Avec arrêt pour limiter l'ouverture à 120° article S2AM37XG**

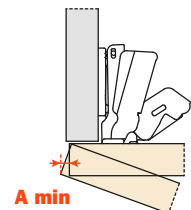

The above values are calculated on the assumption that the doors have square edges. They are reduced if the doors have radiused edges.

Un rayon adéquat de la porte réduit les valeurs de "A" et de "L".

Space needed to open the door
Jeu nécessaire pour l'ouverture de la porte

Projection of the door
 Projection of the door from the cabinet side at the maximum opening. The figures are based on a straight arm hinge, H=0 mm thickness of mounting plate and K value = 3 mm.

Recul de la porte
 Recul de la porte par rapport au côté en position d'ouverture maximum (valeur obtenue avec une charnière bras droit, hauteur de l'embase H=0 et valeur K=3)

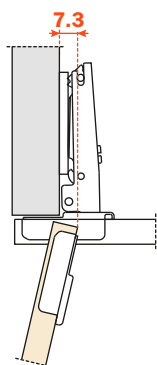

100 series • 105°
Space needed to open the door

T=	15	16	17	18	19	20
K=3 A=	1.0	1.0	1.2	1.4	1.6	1.9
K=4 A=	0.9	1.0	1.2	1.3	1.5	1.8
K=5 A=	0.9	1.0	1.1	1.2	1.5	1.8
K=6 A=	0.9	1.0	1.1	1.2	1.4	1.7

T=	15	16	17	18	19	20
K=3 L=	0.0	0.0	0.0	0.0	0.1	0.3
K=4 L=	0.4	0.6	0.7	0.9	1.1	1.2
K=5 L=	1.0	1.0	1.2	1.8	2.0	2.0
K=6 L=	1.6	1.8	2.0	2.1	2.3	2.5

Série 100 • 105°
Jeu nécessaire pour l'ouverture de la porte

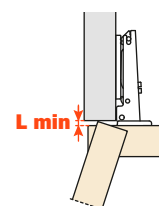
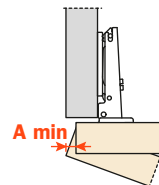

The above values are calculated on the assumption that the doors have square edges. They are reduced if the doors have radiused edges.

Un rayon adéquat de la porte réduit les valeurs de "A" et de "L".

Titanium finish
Finition Titane



The Titanium finish perfectly integrates the hinge into the design of the cabinet conveying a sensation of warmth while at the same time, incorporating modern functionality.

The color, new and different compared to the traditional nickel-plated finishes, is less invasive and has a muted sheen. The Titanium reflections make the hinge ideal in combination with darker interiors and with the numerous shades of exotic wood finishes used in contemporary cabinetry.

Corrosion resistance is greatly enhanced compared to the traditional nickel-plated finishes.

In keeping with today's trends, this elegant Titanium finish is now available on both the standard hinge series as well as the Silentia+ soft close products.

La finition Titane intègre parfaitement la charnière dans le design du meuble. Elle donne une apparence chaleureuse et en même temps technologique.



La couleur, nouvelle et différente par rapport aux finitions traditionnelles bruniées ou nickelées, est moins agressive et moins brillante. Les reflets titanes rendent cette charnière idéale pour les intérieurs sombres et les nombreuses tonalités des différentes essences de bois.

La résistance à la corrosion en est considérablement augmentée par rapport à la finition nickelée classique. Conformément aux tendances actuelles, cette élégante finition Titane est désormais disponible à la fois sur la série de charnières standard et sur les produits à fermeture amortie Silentia+.

More Exceptional products from Salice • Plus de produits exceptionnels de Salice



**Hinges and mounting plates
for all applications**

•
**Charnières et embases
pour toutes les applications**



Slides & Drawers

•
Coulisses & Tiroirs



Vertical lifting hardware

•
**Systèmes de levée et
de coulissement vertical**





Design accessories
•
**Accessoires de
conception**



**Coplanar sliding systems
&
Pocket door hardware**
•
**Systèmes coplanaires
&
Systèmes pour portes
escamotables**



**Storage accessories for
Closets & Kitchens**
•
**Systèmes de rangement
pour Armoires & Cuisines**



Table of contents • Index des références

Part number Référence	page page	Part number Référence	page page	Part number Référence	page page	Part number Référence	page page	Part number Référence	page page
B2R3E09/15	40	BAR3L09F	43	BAU3R49	47	C27BM99	18	C2P4A99	13
B2R3E39/15	40	BAR3L39F	43	BAU3R49XR	47	C27BM99AC	18	C2P4D99	13
B2R3E69/15	40	BAR3L69F	43	BAU3R69	47	C27BN99 + B2S3B99B6/15	21	C2P4G99	13
B2R3E99/15	40	BAR3R09	45	BAU3R69XR	47	C27BN99AC	20	C2P4P99	13
B2RGE09/17	40	BAR3R29	45	BAV3E99F	42	C27BP99	22	C2P6A99	13
B2RGE39/17	40	BAR3R39	45	BAV3EC9F	42	C27BT99	17	C2P6D99	13
B2RGE69/17	40	BAR3R69	45	BAV3EV9F	42	C27BU99	17	C2P6G99	13
B2RGE99/17	40	BAR3R99	45	BAV3M09F	42	C27BV99	18	C2P6N99AM	20
B2V3BC9/15	40	BAR3RC9	45	BAV3M29F	42	C27BW99	19	C2P6P99	13
B2V3BV9/15	40	BAR3RM9	46	BAV3M39F	42	C27BZ99	17	C2P8A99	13
B2V3BW9/15	41	BAR3RU9	46	BAV3M69F	42	C27FA99	14	C2P8D99	13
B2V3BW9R/15	41	BAR3RV9	45	BAV4M09F/16	42	C27FD99	14	C2P8G99	13
B2V3BW9S/15	41	BAR3RY9	46	BAV4M29F/16	42	C27FG99	14	C2P9A99	13
B2V3H09/15	40	BAR3RZ9	46	BAV4M39F/16	42	C27FP99	14	C2P9D99	13
B2V3H39/15	40	BAR4R09/16	45	BAVGE99F/16	42	C27YA99	18	C2P9G99	13
B2V3H69/15	40	BAR4R29/16	45	BAVGE99F/16	42	C2J6A99	13	C2PAA99	22
B2V3H99/15	40	BAR4R39/16	45	BAVGEV9F/16	42	C2J6D99	13	C2PAG99	22
B2VGB9/17	40	BAR4R69/16	45	BAVGM09F/16	42	C2J6G99	13	C2PAP99	22
B2VGBV9/17	40	BARGL09F/16	43	BAVGM29F/16	42	C2J6N99AM	21	C2PBA99	22
B2VGH09/17	40	BARGL39F/16	43	BAVGM39F/16	42	C2J6P99	13	C2PBD99	22
B2VGH39/17	40	BARGL69F/16	43	BAVGM69F/16	42	C2J9A99	13	C2PBE99	17
B2VGH69/17	40	BARGR09/16	45	C1P6A99	12	C2J9D99	13	C2PBG99	22
B2VGH99/17	40	BARGR09/20	45	C1P6D99	12	C2J9G99	13	C2PBH99	19
B383E09	24	BARGR29/16	45	C1P6G99	12	C2JBA99	22	C2PBK99	17
B383E69	24	BARGR29/20	45	C1P6P99	12	C2JBE99	17	C2PBM99	18
BA03R59	48	BARGR39/16	45	C1R6A99	12	C2JBG99	22	C2PBM99AC	18
BAL3R59	48	BARGR39/20	45	C1R6D99	12	C2JBH99	19	C2PBN99 + B2S3B99B6/15	21
BAM3R09	48	BARGR69/16	45	C1R6G99	12	C2JBK99	17	C2PBN99AC	20
BAP3R09	44	BARGR69/20	45	C1R6P99	12	C2JBM99	18	C2PBP99	22
BAP3R29	44	BARGR99/16	45	C276A99	13	C2JBM99AC	18	C2PBT99	17
BAP3R39	44	BARGR99/20	45	C276D99	13	C2JBN99 + B2S3B99B6/15	21	C2PBU99	17
BAP3R69	44	BARGRC9/16	45	C276G99	13	C2JBN99AC	20	C2PBV99	18
BAP3R99	44	BARGRM9/16	46	C276N99AM	20	C2JBP99	22	C2PBW99	19
BAP3RC9	44	BARGRU9/16	46	C276P99	13	C2JBT99	17	C2PBZ99	17
BAP7R09	44	BARGRV9/16	45	C279A99	13	C2JBU99	17	C2PEA99	14
BAP7R29	44	BARGRW9M	41	C279D99	13	C2JBV99	18	C2PED99	14
BAP7R39	44	BARGRY9/16	46	C279G99	13	C2JBW99	19	C2PEG99	14
BAP7R69	44	BARGRZ9/16	46	C27BA99	22	C2JBZ99	17	C2PEP99	14
BAPGR09/16	44	BAU3L19	47	C27BE99	17	C2JFA99	14	C2PFA99	14
BAPGR29/16	44	BAU3L49	47	C27BG99	22	C2JFD99	14	C2PFD99	14
BAPGR39/16	44	BAU3R19	47	C27BH99	19	C2JFG99	14	C2PFG99	14
BAPGR69/16	44	BAU3R19XR	47	C27BK99	17	C2JFP99	14	C2PFP99	14

Part number Référence	page page	Part number Référence	page page	Part number Référence	page page	Part number Référence	page page	Part number Codigo	page page
C2PHA99	15	C2RBN99 + B2S3B99B6/15	21	C8R6C99	25	CSR3299N	54	DP5SNB	64
C2PKA99	23	C2RBN99AC	20	C8R6J99	25	CSR3299NR	56	DP5SNG	64
C2PKD99	23	C2RBP99	22	C8R6L99	25	CSR3499	54	DP82XX3R	68
C2PKG99	23	C2RBT99	17	C8R6S99	25	CSR3499XR	56	DP82XXBR	68
C2PPA99	73	C2RBU99	17	CBP1AC9	26	CSR3599	54	DP82XXGR	68
C2PPG99	73	C2RBV99	18	CBP2AC9	26	CSR3599XR	56	DP82XXQR	68
C2PPP99	73	C2RBW99	19	CBP2AE9	26	CSR3699	54	DP83XX3R	68
C2PRA99	74	C2RBZ99	17	CBPQAC9	26	CSR3699XR	56	DP83XXBR	68
C2PRG99	74	C2REA99	14	CFA5A99	34	CSR3799	54	DP83XXGR	68
C2PRP99	74	C2RED99	14	CFA5G99	34	CSR3799XR	56	DP83XXQR	68
C2PVA99	72	C2REG99	14	CFA5P99	34	CSR3899	54	DP84XX3R	68
C2PVG99	72	C2REP99	14	CFA7A99	34	CSR3999	54	DP84XXBR	68
C2PVN99 + B2S3B99B6/15	75	C2RFA99	14	CFA7G99	34	CSR3A99N	54	DP84XXGR	68
C2PVN99AC	75	C2RFD99	14	CFA7P99	34	CSR3A99NR	56	DP84XXQR	68
C2PVP99	72	C2RFG99	14	CMP3A99	30	CSR3B99N	54	DPASNB	67
C2PYA99	18	C2RFP99	14	CMR3A99	30	CSR3B99NR	56	DPMSNB	67
C2R4A99	13	C2RHA99	15	CSP3199N	54	CSR3C99N	54	S2A637XF	59
C2R4D99	13	C2RKA99	23	CSP3299N	54	CSR3C99NR	56	S2AF37X3	59
C2R4G99	13	C2RKD99	23	CSP3299NR	56	CSR3D99N	54	S2AM37XG	60
C2R4P99	13	C2RKG99	23	CSP3499	54	CSR3D99NR	56	S2BF37XY	59
C2R6A99	13	C2RPA99	73	CSP3499XR	56	CSR3E99N	54	S2BM37XG	60
C2R6D99	13	C2RPG99	73	CSP3599	54	CSR3E99NR	56	S2BX83H9	58
C2R6G99	13	C2RPP99	73	CSP3599XR	56	CSR3Y99	54	S2CX85H9	58
C2R6N99AM	20	C2RRA99	74	CSP3699	54	CSR3Z99	54	S2MX83H9	58
C2R6P99	13	C2RRG99	74	CSP3699XR	56	DBDESN6	26	S2XX83A1	58
C2R8A99	13	C2RRP99	74	CSP3799	54	DP28SN9	67	S2XX85H9	58
C2R8D99	13	C2RVA99	72	CSP3799XR	56	DP29SN3	63	S38X8639	24
C2R8G99	13	C2RVG99	72	CSP3899	54	DP29SN3R	63	S38X86D9	24
C2R9A99	13	C2RVN99 + B2S3B99B6/15	75	CSP3999	54	DP29SNB	63	SAV354X9R	41
C2R9D99	13	C2RVN99AC	75	CSP3A99N	54	DP29SNBR	63	SAV354X9S	41
C2R9G99	13	C2RVP99	72	CSP3A99NR	56	DP29SNG	63	SBA237XG	59
C2RAA99	22	C2RYA99	18	CSP3B99N	54	DP29SNGR	63	SBA237XG	26
C2RAG99	22	C3PBA99	24	CSP3B99NR	56	DP38XX91	67	SBAX78A6SN	26
C2RAP99	22	C3RBA99	24	CSP3C99N	54	DP39XXG	67	SBXX85X6	26
C2RBA99	22	C876C99	25	CSP3C99NR	56	DP3SN3	63	SBXX85X9	26
C2RBD99	22	C876J99	25	CSP3D99N	54	DP3SNB	63	SP44XX3	67
C2RBE99	17	C876L99	25	CSP3D99NR	56	DP3SNG	63	SP44XXB	67
C2RBG99	22	C876S99	25	CSP3E99N	54	DP4SN3	64	SP44XXG	67
C2RBH99	19	C8P6C99	25	CSP3E99NR	56	DP4SNB	64	SSP3377G	60
C2RBK99	17	C8P6J99	25	CSP3Y99	54	DP4SNG	64	SSP337AG	60
C2RBM99	18	C8P6L99	25	CSP3Z99	54	DP50SNO	64	SSXX83	58
C2RBM99AC	18	C8P6S99	25	CSR3199N	54	DP5SN3	64		

SALICE CANADA INC.

3500 RIDGEWAY DRIVE, UNIT#1
MISSISSAUGA, ONTARIO, L5L 0B4
TEL. 905 820 8787
FAX. 905 820 7226
info.salice@salicecanada.com
www.salicecanada.com

Authorized distributor:
Distributeur agréé:

We reserve all rights to this catalogue under copyright law. It shall not be permissible to duplicate this catalogue in any form either in whole or in part without our written consent. The technical specifications in this catalogue as photographs and drawings are not binding. We assume no liability for any misprints or errors that might occur in this catalogue.

Nous nous réservons tous les droits sur ce catalogue en vertu de la loi sur le droit d'auteur. Il n'est pas permis de dupliquer ce catalogue sous quelque forme que ce soit, en totalité ou en partie, sans notre consentement écrit. Les spécifications techniques de ce catalogue comme les photographies et les dessins ne sont pas contractuelles. Nous n'assumons aucune responsabilité pour les fautes d'impression ou les erreurs qui pourraient se produire dans ce catalogue.