



Butler Marketing

Quality Hardware for Cabinets & Millwork

Dear Customer:

It is with pleasure that we offer you our catalogue. It illustrates products that we generally stock but we also accept orders for non-stocked items. On the main page of our website you can link directly to many of our suppliers to see what is available, gain additional information and see what we may be able to special order for you.

We look forward to serving you and thank you for your support.

Address:

#6 - 11771 Horseshoe Way
Richmond, BC V7A 4V4
Phone: 604.279.8228
Fax: 604.279.8242

butlermarketing@telus.net

Derek
Joan
Leanne
Scott

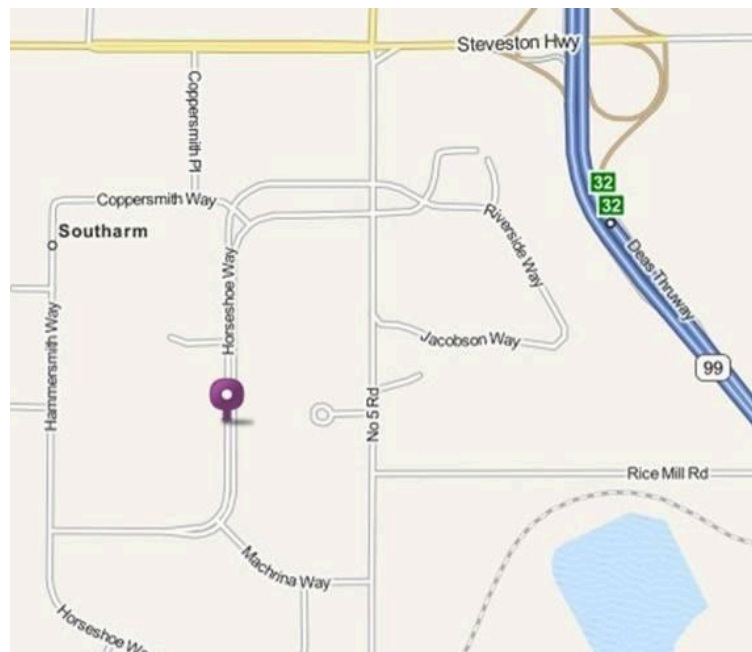

Website: www.butlermarketing.ca



Butler Marketing

Quality Hardware for Cabinets & Millwork

General Information

1. Hours of Operation:

Our sales desk is open Monday through Friday from 8:00 AM to 4:30 PM (local time).

2. How to Contact Us:

Telephone, fax numbers and e-mail addresses are listed on the previous page. Please feel free to drop in and see our showroom and warehouse whenever you are in our area.

3. Minimum Orders:

We are a wholesale distributor to manufacturers. In addition, we supply product to hardware retailers, and support their businesses by **not** selling retail. Our minimum order is \$25.00 and we may apply a \$5.00 service charge to smaller transactions.

4. Terms of Sale:

Our terms are net 30 days. All invoices over 60 days will be considered delinquent, and in-house orders will be placed on hold until the balance of the account is brought current with our terms. Overdue accounts may be subject to interest charges of 1% per month, applied to the overdue balance. Credit Card payments are accepted at time of sale.

5. New Accounts:

We invite you to complete our credit application form. Upon submission, we will advise you of our position in a timely manner. Until credit has been established, we would be selling on a C.O.D. basis.

6. Returned Goods Policy:

If you wish to return goods to us, please advise us first and upon our approval, we may issue a return goods number. This will ensure that returned goods are properly received and credited to the correct account. Full credit will be allowed to cover errors in shipping or defective product. Returns made for any other reason may be subjected to a restocking charge of 20%. A copy of the original invoice may be required.

Obsolete, discontinued or special order products are not returnable



Butler Marketing

Quality Hardware for Cabinets & Millwork

Table of Contents

Section 1	-	Abrasives
Section 2	-	Adhesives
Section 3	-	Furniture Fittings
Section 4	-	Veneers & Tambours
Section 5	-	Edgebanding & Mouldings
Section 6	-	Decorative Hardware
Section 7	-	Hinges
Section 8	-	Drawer Slides & Systems
Section 10	-	Furniture Locks
Section 11	-	Ergonomic Products
Section 12	-	Tools & Machines
Section 13	-	Fasteners
Section 14	-	Shop Supplies
Section 15	-	Kitchen & Bathroom Accessories

Index

A	Adhesives	Section 2
	Angle Brackets	Page 3.12
B	Back-up Pads	Page 1.5
	Ball Catch	Page 3.10
	Bed Fittings	Page 3.11
	Belt Cleaners	Page 1.7
	Belt Rack	Page 3.22
	Biscuits, Lamello	Page 3.13
	Blade and Bit Cleaner	Page 12.3
	Brackets	Page 3.6, 3.12
	Brad Nails	Page 13.8
	Bullet Catch	Page 3.10
	Bumper Pads	Page 3.6
C	Cabinet Knobs	Page 6.8
	Cabinet Pulls	Page 6.1
	Cam Locks	Page 10.1
	Cams & Dowels	Page 3.15
	Casters	Page 3.20
	Catches & Latches	Page 3.8
	CGS 120lb Full Extension Slides, Regular & Soft Close	Page 8.8
	Closet Accessories	Page 3.22
	Closet Rods and Fittings	Page 3.7
	CMT Sawblades & Router Bits	Page 12.3
	Coat Hooks	Page 3.21
	Colorstik	Page 2.4
	Confirmat Screws	Page 13.5
	Connector Cams & Dowels	Page 3.15
	Connectors	Page 13.9
	Construction Adhesive	Page 2.3
	Cover Caps	Page 13.7
	Cross Dowels	Page 13.11
D	Desk Grommets	Page 3.16
	Desktop Sit-Stand Workstation	Page 11.1
	Door Protectors	Page 8.3
	Drawer Guides – Wooden	Page 8.9
	Drawer Front Adjusters	Page 3.15
	Drawer Locks	Page 10.1
	Drawer Slides	Section 8
	Drill Bits	Page 12.2
	Driver Bits	Page 12.1
	Dust Mask	Page 14.2

E	Ear Plugs	Page 14.2
	Edge trimmers	Page 12.4
	Edgetape	Section 5
	Ergonomic Products	Section 11
	Euro Screws	Page 13.5
F	Fastedge Edgebanding	Page 5.6
	Fasteners	Page 13.10
	File Holders/Drawer Divider Clips	Page 3.18
	Flap Hinge	Page 7.8
	Flap Stays	Page 3.21
	Foam Protection	Page 14.1
G	Glass Door Hinges	Page 7.5
	Glass Retaining Clips	Page 3.21
	Graphite Rolls	Page 1.7
	Grill, Vent	Page 3.17
H	Hinge, Commercial	Page 7.13
	Hinge, Concealed	Page 7.6
	Hinge, Face Frame	Page 7.3
	Hinge, Lift	Page 7.14
	Hinge, Non-Mortise	Page 7.6
	Hinge, Piano	Page 7.7
	Hinge, Pocket Door	Page 7.14
	Hinge, Residential Door	Page 7.12
	Hinge, Salice	Page 7.1
	Hole Plugs	Page 13.7
	Hot Melt Adhesives, Cleaners	Page 2.2-2.3
I	Insert Nuts	Page 13.10
	Installation Screws	Page 13.5
	Instantbond	Page 2.3
	Institutional Hinges - RPC	Page 7.10
J	Joint Connector Bolts	Page 13.9
	Joint Fastener	Page 3.14
K	KV Heavy Duty Slides	Page 8.6
	KV Pocket Door Slides	Page 8.9
	KV Precision Ball Bearing Slides	Page 8.4
	KV Stainless Steel Slides	Page 8.6
L	Lamello Biscuits	Page 3.13
	Lazy Susans - Poly	Page 15.8
	Leg Levellers	Page 3.19
	Locks	Section 10

M	Melamine Edgebanding	Page 5.6
	Mending Plate	Page 3.12
	Mirror, Swivel	Page 3.2
	Miscellaneous Fittings	Page 3.21
	Miscellaneous Hinges	Page 7.7
	Miscellaneous Locks	Page 10.5
	Monitor Supports	Page 11.3
N	Nail Glides	Page 3.21
P	Paper Sheets	Page 1.4
	Peel and Stick Edgebanding	Page 5.6
	Pencil Trays	Page 3.18
	Piano Hinges	Page 7.7
	Plastic Mouldings	Page 5.7
	Pocket Door System	Page 7.14
	Portable Belts	Page 1.1
	PVA Adhesives	Section 2
	PVC Thick	Page 5.3
	PVC Solid Colours/Woodgrains	Page 5.1
R	Rags, Ganzie	Page 14.1
	Recycling Bins	Page 15.1
	Restaurant Table Hinge	Page 3.19
	Retaining Clips	Page 3.21
	Rolls	Page 1.4
	Router Bits	Page 12.3
	RPC Hinges	Page 7.10
S	Salice Hinges	Page 7.1
	Salice Futura Undermount Slides	Page 8.1
	Sanding Belts – Cloth	Page 1.2
	Sanding Belts - Paper	Page 1.3
	Sanding Blocks/Sponges/Pads	Page 1.8
	Sanding Discs	Page 1.6
	Sandpaper Rolls	Page 1.4
	Sandpaper Sheets	Page 1.4
	Sash Table Locks	Page 3.19
	Sawblades	Page 12.3
	Screw Caps	Page 13.6
	Screws - Confirmat	Page 13.5
	Screws - Euro	Page 13.5
	Screws - Flathead	Page 13.2
	Screws - Installation	Page 13.5
	Screws - Panhead	Page 13.2
	Screws - The MAXX	Page 13.1

S	Screws - Trusshead	Page 13.4
	Screws - Washerhead	Page 13.1
	Sealants	Page 2.3
	Seamfil	Page 2.5
	Secret Gate Latch	Page 3.10
	Sheet Veneer	Page 4.3
	Shelf Brackets	Page 3.6
	Shelf Standards & Brackets	Page 3.2
	Shelf Supports	Page 3.1
	Shop Supplies	Section 14
	Sink Front Clips	Page 3.15 & 15.4
	Sink Front Hinges	Page 15.5
	Sink Front Trays	Page 15.5
	Sit-Stand Workstation	Page 11.2
	Slides - Full Extension	Page 8.4
	Slides - Pocket Door	Page 8.9
	Slides - Stainless Steel	Page 8.6
	Slides - Undermount (Soft Close)	Page 8.1
	Slides - Undermount (Push)	Page 8.1
	Soft Close Ball Bearing Slide	Page 8.8
	Soft Wax	Page 2.4
	Solvent Based Contact Adhesives	Page 2.2
	Spacers	Page 8.3
	Specialty Locks	Page 10.5
	Speedtape	Page 5.6
	Stainless Standards & Brackets	Page 3.5
	Stainless Steel Shelving	Page 3.5
	Stainless Steel Slides	Page 8.7
	Standards & Brackets	Page 3.2
	Staples	Page 13.8
	Stemware Holder	Page 15.7
	Stretch Wrap	Page 14.2
T	Table Frame Kits	Page 11.2
	Table Hardware	Page 3.19
	Table Legs	Page 3.20
	Tambour Door Kits	Page 4.4
	Taper Connector	Page 3.14
	Tie Rack	Page 3.22
	Timberline Locks - Removable Core	Page 10.1
	Towel Bars	Page 15.9
	Traditional Hinges	Page 7.6
	Tray Dividers	Page 15.6
	Turntables & Swivels	Page 3.16

U	Undermount Soft Close Slide Futura	Page 8.1
	Undermount Push Slide Futura	Page 8.1
	Upholstery Adhesives	Page 2.2
V	Veneer Edge Tape	Page 5.4
	Veneer Sheets	Page 4.3
	Vent Grill	Page 3.17
W	Washer Head Screws	Page 13.1
	Waste & Recycling Bins	Page 15.3
	Water Based Contact Adhesives	Page 2.1
	Water Based Woodworking Adhesives	Page 2.1
	Wine Racks/Bottle Holders	Page 15.7
	Wood Dowels Fluted	Page 3.13
	Wood Veneer Edgebanding	Page 5.5
	Wooden Drawer Guides	Page 8.9
	Wrap, Stretch and Pallet	Page 14.3

To do is to be *Socrates*
To be is to do *Sartre*
Do be do be do *Sinatra*

Section 1 • Abrasives

Table of Contents

Portable Belts	Page 1.1
Sanding Belts - Cloth	Page 1.2
Sanding Belts - Paper	Page 1.3
Paper Sheets	Page 1.4
Rolls	Page 1.4
Back-up Pads	Page 1.5
Discs	Page 1.6
Belt Cleaners	Page 1.7
Graphite Rolls	Page 1.7
Sanding Blocks/Sponges/Pads	Page 1.8
Miscellaneous Sanding	Page 1.9

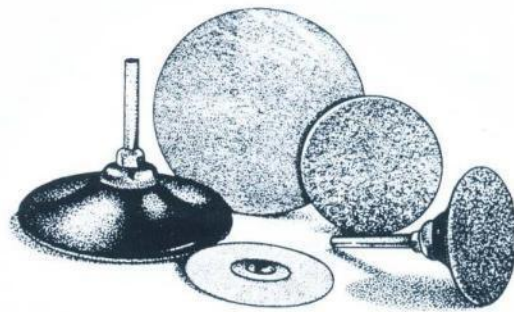

To learn more about fine sanding products available to us, visit the Sia website at: <https://www.siaabrasives.com/> or CGW website at: www.cgwcamel.com.

Abrasive Grains

Coated abrasives are manufactured using abrasive grains; the most common are aluminum oxide, zirconium, ceramic, silicon carbide and garnet. The crude grains are crushed and separated into sizes, called grit sizes, using calibrated screens. Grits range from 12 (very coarse) to 2,000 (very fine). Once the grains are separated into sizes, they are attached to a backing material using various bond techniques. Below are descriptions of the most common abrasive grains:

Ceramic

A high performance, man-made abrasive material. Very uniform, high density grain structure is extremely durable and self sharpening for longer life and cooler cut. Excels on tough to grind materials.

Aluminum Oxide

A tough, blocky shaped, man-made grain used for high speed grinding and finishing of metals, wood and other high tensile strength materials without excessive fracturing or shedding. Wherever the ability to resist fracturing is the main consideration, aluminum oxide will outperform all other coated abrasive grains.

Zirconium

A very fine, dense, man-made crystalline grain which can be used for aggressive stock removal. Zirconium is a very dense material with a unique self-sharpening characteristic which gives it long life on heavy stock removal operations.

Silicon Carbide

A very hard, very sharp, man-made abrasive suited for non-ferrous materials and non-metallic materials such as concrete, marble and glass. A very friable grain, silicon carbide cuts faster under light pressure than any other grain used in coated abrasives.

Garnet

Garnet is made of natural aluminum oxide which is a relatively sharp, but very weak bonding structure. Very inconsistent when compared to synthetics. It is used primarily in woodworking as garnet dulls too quickly to be used in metalworking.

Backing Materials - Substrates

Below are the four major types of backing materials:

Paper

Specialized technical papers are used as substrates for coated abrasives. They are identified by letters representing weight and flexibility:

"A" and "B" weights are light weight and highly flexible. "C", "D", "E", "F" weights are medium to heavy weight for more strength and less flexibility.

Cloth

Cloth backings are more durable than paper backings. There are several types of cloth backings: cotton (ie: Egyptian), polyester and polyester-cotton blends. Cloth backings are identified by weight and flexibility:

"F" weight (J-Flex) is light and highly flexible. This lighter weight is suitable for cleaning, finishing and polishing.

"J" weight (Jeans) is highly flexible and suitable for cleaning, finishing and polishing of contour surfaces.

"X" weight (Drills) is medium to heavy weight for more strength and durability. It has low flexibility suitable for grinding, deburring and finishing.

"H" (Heavy Duty) is a heavier weight than "X" weight. It has low flexibility and is suitable for heavy duty grinding and deburring applications. Excellent edge stability.

ABRASIVE GRAIN COVERAGE

The manner in which the abrasive grains are distributed on the backing is referred to as its "Coating". The two levels of abrasive grain density are **open coat** and **closed coat**.

Open Coat:
Abrasive grains cover approximately **50% - 60% of the coated surface**. Open coat products generally offer greater flexibility, faster cutting, coarser finish and provide a greater resistance to loading. Open coat products are used **widely for woodworking applications**, with limited applications for metal.

Closed Coat:
Abrasive grains cover **100% of the coated surface**. The greater number of abrasive grains normally results in a better finish and a higher amount of stock removal during the useful life of the product. If loading is not a problem, a closed coat product will give you superior life and lower cost. Closed coat products are widely **used in metalworking and woodworking applications**.

Abrasive Belts

Standard Belt Splices

STANDARD SPLICES

Narrow Belts - All Grits

- Butt Splice - **Straight Cut 67°** our Standard Splice
- Butt Splice - **Pascolock Cut 67°** available at no extra cost
- Lap Splice 67° available

Wide Belts 24 - 50 Grit

- Butt Splice - Straight Cut 67°

Wide Belts up to 67" wide, 60 Grit & Finer

- Butt Splice - Pascolock Cut 67°
- Butt Splice - Straight Cut 67° available

Wide Belts Zirconia

- Butt Splice - Straight Cut 67°

TAPE-ON-TOP SPLICE

- All Materials + 7% additional
The perfect bump free splice, can only be used with a platen or solid steel contact wheel.



Butt Splice, Straight Cut: strong bi-directional tape splice. Our standard splice for narrow belts

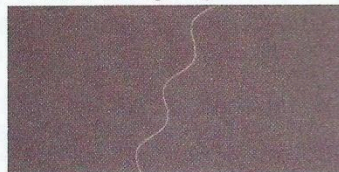
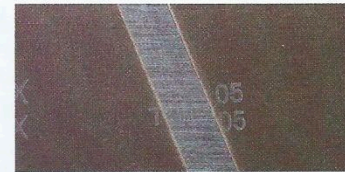

Pascolock Splice: strong bi-directional tape splice, used mainly to improve finish on wide belts which reduces hinging and eliminates splice marks. Also available for narrow belts.



Lap Splice Top Skived: may only be run in one direction. Best for shape sanding with "J" Wgt. cloth belts.

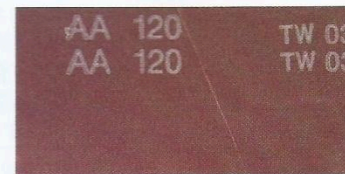

Tape-On-Top Splice: ONLY for applications with either platen or steel contact wheel. The abrasive grain is removed and the tape is applied to the grain side of the belt. This provides a bi-directional splice that is thinner at the splice than the rest of the belt.

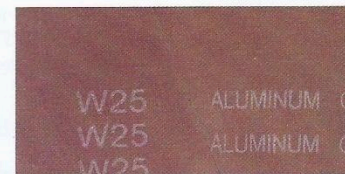

1/4" Lap Splice: ONLY available on paper wide belts. Our new belt splicing technology enables us to manufacture 1/4" lap splices on paper belts with a ± 0.000 tolerance. With more companies seeing the advantages of paper belts, PASCO has become a leader in providing "bump free" paper belts.

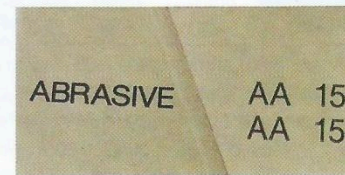

An 80" X 150" wide resin cloth sectional belt with Tape-On-Top Splices. We make belts up to 128" wide

The vast majority of abrasive belts today utilize a taped joint, commonly referred to as a "butt joint". Butt joints offer a very strong joint and consistency relative to the thickness of the joint. These types of joints have been instrumental in helping the coated abrasive industry to increase the automation process of manufacturing abrasive belts. Lap joints are rarely used today except for shape sanding, where it is superior to a butt joint, and some applications of wide belts. Most splices are cut at a 67° angle to the side of the belt.

Portable Belts

Grits In Stock (x)

Size (")	Material	36	40	50	60	80	100	120	150	180
3 x 21	XW341	x	x	x	x	x	x	x	x	x
3 x 24	XW341	x	x	x	x	x	x	x	x	x
4 x 24	XW341		x	x	x	x	x	x	x	x

- other sizes and grits available in 10 days. Package quantity= 10 belts
- inquire if an x does not appear as stocked ... new items are added as requested

Materials:

XW341 (stocked): An open coat aluminum oxide abrasive resin bonded onto an “x” weight cloth backing. Suitable for hardwood sanding from 60-220 grits.

XZ 677 (special order): A closed coat zirconia grain bonded onto an “x” weight cloth backing. Ideal for high cutting performance and longer working life.



Sanding Belts - Cloth

Grits in Stock (x)

Size (")	Material	24	36	40	50	60	80	100	120	150	180	220
Edge												
6 x 48	XW341						X	X	X			
6 x 80	XW341					X	X	X	X			
6 x 89	XW341						X	X	X			
6 x 108	XW341					X	X	X	X	X		
6 x 158	XW341						X	X	X			
9 X 138-½	XW341							X	X			
Wide												
25 x 60	XW341					X	X	X	X	X	X	
37 x 60	XW341					X	X	X	X	X	X	
37 x 75	XW341						X	X	X			
43 x 75	XW341					X	X	X	X			
44 x 75	XW341						X	X	X			
44 x 85	XW341						X	X	X	X	X	
52 x 75	XW341							X		X	X	
54 x 103	XW341						X	X	X	X		

- edge sanding belts 10/box
- wide sanding belts 5/box
- inquire if an x does not appear as stocked ... new items are added as requested

Material:

XW341: An open coat aluminum oxide abrasive resin bonded onto an “x” weight cloth backing. Suitable for hardwood sanding from 60-220 grits.



Sanding Belts - Paper

Grits in Stock (x)

Size (")	Material	24	36	40	50	60	80	100	120	150	180	220
6 x 264	B317							x	x	x		
6 x 294	B317							x	x	x		
6 x 306	B317							x	x	x		
6 x 315	B317							x	x	x		
25 x 75	B317						x	x	x			
36 x 75	B317						x	x	x	x		
37 x 75	B317						x	x	x	x		
44 x 75	B317							x	x	x		
44 x 85	B317						x	x	x	x		
54 x 85	B317								x	x		
54 x 85	B347										x	x
54 x 103	B317							x	x	x	x	

- stroke sanding belts - 10/box
- wide sanding belts - 5/box
- other grits available on special order. Package quantity= 5 belts
- inquire if an x does not appear as stocked ... new items are added as requested

Materials:

B317:

An aluminum oxide "F" weight open coat resin paper product. This product has an antistatic treatment which helps eliminate or minimize dust build up in the machine. Suitable for medium and fine sanding of hardwoods.

B347:

An aluminum oxide "F" weight closed coat resin paper product. This product has an antistatic treatment which helps eliminate or minimize dust build up in the machine. Suitable for medium and fine sanding. This is the recommended product on the final head of the multiple head machines for longer life and better finish than open crated product. Use this material on all grit sizes finer than 150 grit.

Paper Sheets

Grits in Stock (x)

Size (")	Material	40 grit -1500 grit	Pkg
9 x 11	Siaflex 1948	x	50

- other sizes and grits available on special order. Package qty.= 50 sheets
- inquire if an x does not appear as stocked ... new items are added as requested

Material:

Siaflex 1948: Aluminum oxide on a glass fibre reinforced latex paper. Stearated on 180-600 grit. Suitable for general use in wet and dry sanding applications.

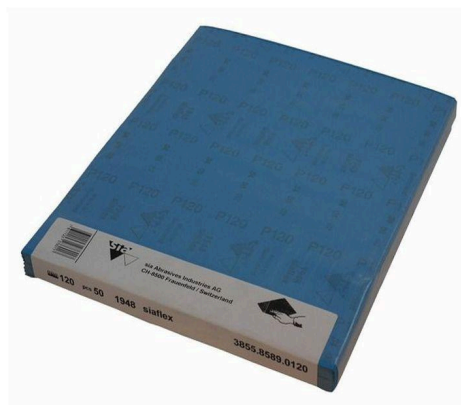

Rolls (All abrasives are available in roll form)

Grits in Stock (x)

Size (")	Material	40	50	60	80	100	120	150	180	220	240	280
3" x 50 yards	XW341											x
4" x 50 yards	XW341			x	x	x	x					

- other sizes and grits available on special order. Package quantity = 1 Roll
- inquire if an x does not appear as stocked ... new items are added as requested
- ideal product for spiral drum sanders

Material:

XW341:

An open coat aluminum oxide abrasive resin bonded onto an "x" weight cloth backing. Suitable for hardwood sanding from 60-220 grits.



Back-up Pads

Item #	Description	Diam/Hole	Pack.
For PSA			
01H-41500	Back-up Pad 5/16-24	5" N/H	1
01H-41600	Back -up Pad 5/16-24	6" N/H	1
For Hook & Loop			
01H-42500H	Back -up Pad Hard 5/16-24	5" N/H	1
01H-42500S	Back-up Pad Soft 5/16-24	5" N/H	1
01H-42550	Back -up Pad 5/16-24	5" 5 Hole	1
01H-42554H	Back-up Pad Hard	5" 54 Hole	1
01H-42554S	Back-up Pad Soft	5" 54 Hole	1
01H-42580	Back -up Pad 5/16-24	5" 8 Hole	1
01H-42583	Back -up Pad 5/16-24 - w/3 screws	5" 8 Hole	1
01H-42600	Back-up Pad 5/16-24	6" N/H	1
01H-426103ES	Back-up Pad 5/16 Extra Soft	6"/103 Hole	1
01H-426103S	Back-up Pad 5/16 Soft	6"/103 Hole	1
01H-42660	Back-up Pad 5/16-24	6" 6 Hole	1

- back-up pads are medium profile
- firm density available to special order



Convert PSA to Hook & Loop

Item #	Description	Diam/Hole	Pack.
01H-45005	PSA to H&L	5" N/H	1
01H-45006	PSA to H&L	6" N/H	1

Discs - Aluminum Oxide

Hook & Loop

Size (")	Material	Grits Available
5" diam. N/H	Q711T/1948	40-600 Grit
5" diam. 8 hole	Q711T/1948	60-320 Grit
5" diam. FiboTec 41h	1948	80-220 Grit
6" diam. N/H	Q711T/1948	80-800 Grit
6" diam. 6 hole	Q711T/1948	100-200 Grit
6" diam. FiboTec 59h	1948	80-180 Grit

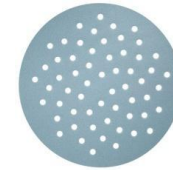

- other sizes and grits available on special order. Package quantity = 100 discs
- inquire if an x does not appear as stocked ... new items are added as requested

Check out Sia Abrasives Industries video online at:
https://youtu.be/q_2zvHTRDeI



PSA

Size (")	Material	Grits Available
5" diam. N/H	Q711T/1948	80-400 Grit
6" diam. N/H	Q711T/1948	100-400 Grit

- other sizes and grits available on special order. Package quantity = 100 discs
- inquire if an x does not appear as stocked ... new items are added as requested

Material:

Q711T: Film backing – longer life, strong yet pliable .003 mylar backing offers up to 4x the life vs. paper discs. Zinc stearate coating for less loading and longer life. Full phenolic resin bond system

1948: Glassfibre – reinforced latex paper provides outstanding flexibility. With waterproof abrasive components can be used wet or dry. Aluminum oxide with stearate on 180 to 800 grit. High removal rates with low scratch depths

Net (Sianet)

Size (")	Material	Grits Available
5" diam.	7900 Sianet	80-600 Grit
6" diam.	7900 Sianet	80-600 Grit

- other sizes and grits available on special order. Package quantity = 50 discs
- Full surface dust extraction
- High removal rate without clogging
- Tear resistant due to sturdy net backing
- Works with any hook and loop back up pad with holes
- Ideal for wood containing oil or resins

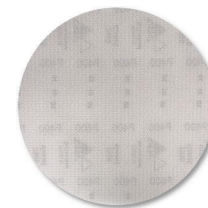

Discs – Ceramic

Grits in Stock (x)

Size (") Pack.	Style	80	100	120	150	180	220	320	
5" diam	Hook & Loop	x	x	x	x	x	x	x	100/box
6" diam	Hook & Loop	x	x	x	x	x	x	x	100/box
5" diam	PSA (Disc on Roll)	x	x	x	x	x	x	x	100/roll
6" diam	PSA (Disc on Roll)	x	x	x	x	x	x	x	100/roll

- eXtreme Premium Sanding Discs
- Ceramic, C-Weight Latex Paper Backing, Open Coat
- Premium sharp ceramic grain for best sanding result
- Consistent finish with 2X life over conventional discs
- Anti-clogging with stearate coating resists loading
- Maximum performance relative to cost



Belt Cleaners

Item #	Description	Pack.
01H-20000	Rubber Cleaning Block 2" x 2" x 8"	1
01H-20001	Rubber Cleaning Block 1-½" x 1-½" x 8"	1

- for use on edge sanding and portable belts only;
- DO NOT use on wide belts as this can be extremely hazardous.

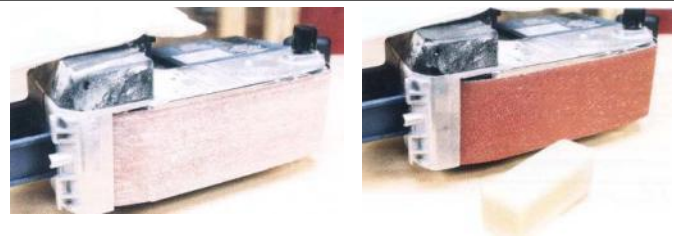

Graphite Rolls

Item #	Description	Pack.
01H-30000	Graphite Roll 6" x 10 yard	1
01H-30008	Graphite Roll 8" x 10 yard	1

- other widths and lengths available to special order
- Graphite coated canvas will extend the life of your belts by reducing heat and friction



Sanding Blocks/Pads

Siasponge Sanding Blocks (Sia 7990) - 2-3/4" x 4" x 1"

Item #	Description	Grit	Colour	Hard/Soft
01J-11002	Siasponge Block	120 (Coarse)	Red	Hard
01J-11005	Siasponge Block	180 (Medium)	Orange	Hard
01J-11007	Siasponge Block	240 (Fine)	Yellow	Hard
01J-11011	Siasponge Block	320 (Superfine)	Green	Hard
01J-11012	Siasponge Block	400 (Ultrafine)	Blue	Soft
01J-12007	Combination Block	240 (Fine)		



Siasponge Flat Pads (Sia 7979) - 4-1/2" x 5-1/2" x 3/16"

01J-20280	Siasponge Flat Pad	120-180 (Medium)	Orange
01J-20500	Siasponge Flat Pad	240-320 (Fine)	Yellow
01J-20800	Siasponge Flat Pad	500-600 (Superfine)	Green
01J-21000	Siasponge Flat Pad	800-1000 (Ultrafine)	Blue
01J-21500	Siasponge Flat Pad	1200-1500 (Microfine)	Violet

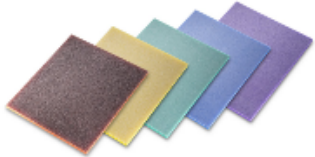

Hand Pads - 6" x 9"

01J-30000	Hand Pad 6"x9"	Gen. Purpose	Green
01J-30010	Hand Pad 6"x9"	Abrasive Free	White
01J-31000	Hand Pad 6"x9"	Very Fine	Maroon



Siasponge Flex Pad (Sia 7983) - 4" x 4-3/4" x 1/2"

01J-40005	Siasponge Pad	120-180 (Medium)	Orange
01J-40007	Siasponge Pad	240-320 (Fine)	Yellow
01J-40010	Siasponge Pad	500-600 (Superfine)	Green
01J-40012	Siasponge Pad	800-1000 (Ultrafine)	Blue



Siafast Handblock - 2-3/4" x 5"

01J-13000	Handblock Siafast	(double density)
-----------	-------------------	------------------

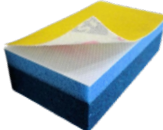

Miscellaneous Sanding

Siaflex 1948

Item #	Description	Size	Grit	Pack.
01J-14080	Siaflex 1948	2-3/4" x 5"	80 grit	100
01J-14100	Siaflex 1948	2-3/4" x 5"	100 grit	100
01J-14120	Siaflex 1948	2-3/4" x 5"	120 grit	100
01J-14150	Siaflex 1948	2-3/4" x 5"	150 grit	100
01J-14180	Siaflex 1948	2-3/4" x 5"	180 grit	100
01J-14220	Siaflex 1948	2-3/4" x 5"	220 grit	100
01J-14280	Siaflex 1948	2-3/4" x 5"	280 grit	100
01J-14320	Siaflex 1948	2-3/4" x 5"	320 grit	100
01J-14400	Siaflex 1948	2-3/4" x 5"	400 grit	100



Siasoft Strip 1748

01S-20320	Siasoft Strip 1748	4-1/2" x 5-1/2"	320 grit	50
01S-20400	Siasoft Strip 1748	4-1/2" x 5-1/2"	400 grit	50



Siasoft Roll 2951

01S-30080	Siasoft Roll 2951	3-1/2" x 11 yards	80 grit	1
01S-30120	Siasoft Roll 2951	3-1/2" x 11 yards	120 grit	1
01S-31120	Siasoft Roll 2951	4-1/2" x 11 yards	80 grit	1



Siasoft Roll

01S-40120	Siasoft Roll 1948	4-1/2" x 5" - 27 yards	120 grit	1
01S-40150	Siasoft Roll 1948	4-1/2" x 5" - 27 yards	150 grit	1
01S-40180	Siasoft Roll 1948	4-1/2" x 5" - 27 yards	180 grit	1
01S-40220	Siasoft Roll 1948	4-1/2" x 5" - 27 yards	220 grit	1
01S-40320	Siafit Roll 1904	4-1/2" x 5" - 27 yards	320 grit	1



Section 2 • Adhesives

Table of Contents

Water Based Woodworking Adhesives	Page 2.1
Water Based Contact Adhesives	Page 2.1
Solvent Based Contact Adhesives	Page 2.2
Upholstery Adhesives	Page 2.2
Hot Melt Adhesives	Page 2.2
Construction Adhesives	Page 2.3
Solvents and Thinners	Page 2.3
Sealants	Page 2.3
Soft Wax	Page 2.4
Colorstik	Page 2.4
Seamfil	Page 2.5

We are happy to provide all the technical assistance you may require. In addition to our own staff, full time Helmitin technical sales people and chemists assist us in providing the best advice. Technical bulletins and MSDS reports are readily available and can be viewed on our website. Helmitin can be visited online at www.helmitin.com.



Helmitin Water-Based Adhesive

Item #	Description
02A-10020	842 General Purpose PVA 18.9 Litres
02A-10053	842 General Purpose PVA 226 kg
02A-10104	847 Premium Quality White PVA 3.78 Litres
02A-10120	847 Premium Quality White PVA 18.9 Litres
02A-10304	890 Specialty Emulsion 3.78 Litres
02A-10320	890 Specialty Emulsion 18.9 Litres
02A-10404	805 Pre-catalyzed Type II PVA 3.78 Litres
02A-10420	805 Pre-catalyzed Type II PVA 18.9 Litres
02A-10504	833 Type 1 PVA 3.78 Litres
02A-10520	833 Type 1 PVA 18.9 Litres
02A-10704	856 Fast Set PVA Adhesive 3.78 Litres
02A-10720	856 Fast Set PVA Adhesive 18.9 Litres
02A-10820	816 Veneering Type 11 PVA 18.9 Litres
02A-11775	1775 Water Based Contact Adhesive 37# Canister
02A-21204	775 Water Based Contact Adhesive 3.78 Litres
02A-21220	775 Water Based Contact Adhesive 18.9 Litres
02A-42020	895 WH Vacuum Press Adhesive 18.9 Litres
02A-42212	895 WH Vacuum Press Adhesive 212 kg
02A-43020	885 WH Vacuum Press Adhesive 18.9 Litres
02A-43200	885 WH Vacuum Press Adhesive 220 kg



Helmitin Solvent Based Adhesives

Item #	Description
In Bulk	
02B-10004	4535 Brush Contact Adhesive 3.78 Litres
02B-10020	4535 Brush Contact Adhesive 18.9 Litres
02B-10320	4545 Spray Contact Adhesive Natural 18.9 Litres
02B-10353	4545 Spray Contact Adhesive Natural 161 Kg
02B-10420	4009RD Spray Contact Adhesive Red 18.9 Litres
02B-10520	1535 Non-flam Upholstery Adhesive Natural 18.9 Litres
02B-10520PK	1535 Non-flam Upholstery Adhesive Pink 18.9 Litres
02B-21020	4510 Non-flam Contact Post-Form Adhesive 18.9 Litres
02B-22020	1585 Non-flam Contact Gen. Purpose 18.9 Litres
In Canisters	
02B-16160	1616 Helmistik General Purpose 15 oz.
02B-16350	1635 Helmistik Foam Adhesive 17 oz.
02B-16500	1650 Helmistik Mist Spray 15 oz.
02B-16750	1675 Helmistik Cal. Compliant Contact 15 oz.
02B-16800	1680 Helmistik 15 oz.
02B-16801	1680 Helmistik 30#
02B-16802	1680 Helmistik 140#



Helmitin Hot Melt Adhesives

Item #	Description
02C-11001	Cartridge Hot melt white (Jowat)
02C-51001	Cartridge Hot melt clear (Jowat)
02C-10002	480 Hot melt pellets white
02C-20002	482 Hot melt pellets natural
02C-30002	483 Hot melt pellets seamless
02C-30003	483CL Hot melt pellets clear
02C-90406	406 Hot melt low temp natural
02C-50497	497 Hot melt pellets clear
02C-70000	470 Hot melt pellets (for HPL)



Helmitin Adhesive Solvents & Specialties

Item #	Description
02D-10000	Solvent 1667 in 9# canister
02D-31000	Spray Gun c/w tip
02D-31010	Tip for 1680 (6501)
02D-31012	Tip for 1776 (730077)
02D-31912	Hose 12'
02D-31918	Hose 18'
02D-40100	Plastic Glue Bottle with tip
02D-62000	Citrus Cleaner 14 oz
02D-80004	665 Flammable Solvent 3.78 Litres
02D-80020	665 Flammable Solvent 18.9 Litres
02D-80053	665 Flammable Solvent 53 gal.



Construction Adhesive

Item #	Description	Size	Pkg.
02D-70410	Titebond, Heavy Duty	311ml	1/12
02D-70248	Titebond, Heavy Duty	828ml	1/12
02D-70510	Polyflex Titan, Heavy Duty	300ml	1/24

Instantbond

Item #	Description	Size	Pkg.
02E-20200	Instantbond	170g/50ml Adh. Kit	1/6
02E-20400	Instantbond	330g/100ml Adh. Kit	1/6

Cleaner

Item #	Description	Size	Pkg.
02D-62000	Citrus Cleaner	14oz	1/12

Sealant

Item #	Description	Size	Pkg.
02F-10000	Polyflex Silicone, Translucent White	300 ml	1/12
02F-20000	Polyflex Acrycoat, Acrylic, White	300 ml	1/12

Colorstik

For repair of scratches and nicks and fill in nail holes on finished wood. Choose the right colour, rub the Colorstik into the defect and wipe the excess off with a clean cloth.

Item #	Description	Pack.
02K-04030	Colorstik White	1/12
02K-04032	Colorstik Dark Walnut	1/12
02K-04033	Colorstik Oak	1/12
02K-04035	Colorstik Teak	1/12
02K-04036	Colorstik Dark Birch	1/12
02K-04037	Colorstik Cherry	1/12
02K-04038	Colorstik Black	1/12
02K-04039	Colorstik Dark Mahogany	1/12
02K-04040	Colorstik Light Walnut	1/12
02K-04041	Colorstik Dark Maple	1/12

Soft Wax

Item #	Description	Pack.
02K-03000	Soft Wax Kit	1
02K-03001	Soft Wax – Refill #1-20	1

Seamfil



Seamfil is a hard-curing liquid plastic used to fill joints and cracks in plastic laminates. Match any laminate pattern, colour or woodgrain, by applying Seamfil directly or, in some cases, by mixing several colours using the colour guide.

Item #	Description	Pack.
02K-30010	Seamfil Solvent - 237ml	1/6
02K-30020	Seamfil Solvent - 946ml	1/6
02K-30901	Seamfil White - 1oz	1/12
02K-30902	Seamfil Grey - 1oz	1/12
02K-30904	Seamfil Tan - 1oz	1/12
02K-30913	Seamfil Brown - 1oz	1/12
02K-30914	Seamfil Black - 1oz	1/12
02K-30918	Seamfil Mahogany - 1oz	1/12
02K-30919	Seamfil Pink - 1oz	1/12
02K-20931	Seamfil Maple - 1oz	1/12
02K-30933	Seamfil Teak - 1oz	1/12
02K-30935	Seamfil Birch - 1oz	1/12
02K-30936	Seamfil Primary Yellow - 1oz	1/12
02K-30937	Seamfil Primary Red - 1oz	1/12
02K-30939	Seamfil Olive - 1oz	1/12
02K-30940	Seamfil Orange - 1oz	1/12
02K-30941	Seamfil Almond - 1oz	1/12
02K-30942	Seamfil Butcher - 1oz	1/12
02K-3030943	Seamfil Clear Gloss - 1oz	1/12
02K-30944	Seamfil Retarder = 1oz	1/12
02K-30945	Seamfil Spectrum Green - 1oz	1/12
02K-30946	Seamfil Spectrum Blue - 1oz	1/12
02K-31572	Seamfil Antique White - 1oz	1/12



Section 3 • Furniture Fittings

Table of Contents

Shelf Supports	Page 3.1
Shelf Standards & Brackets	Page 3.2
Stainless Standards & Brackets	Page 3.5
Shelf Brackets	Page 3.6
Bumper Pads	Page 3.6
Closet Rods and Fittings	Page 3.7
Catches & Latches	Page 3.8
Bed Fittings	Page 3.11
Assembly Fittings	Page 3.12
Lamello Biscuits	Page 3.13
Connector Cams & Dowels	Page 3.15
Turntables & Swivels	Page 3.16
Desk Grommets	Page 3.16
File Holders/Drawer Divider Clips	Page 3.18
Pencil Trays	Page 3.18
Table Hardware	Page 3.19
Table Legs	Page 3.20
Casters	Page 3.20
Miscellaneous Fittings	Page 3.21
Closet Accessories	Page 3.22

A bicycle cannot stand on its own because it is two tired.

Shelf Supports

Item #	Finish	Description	Pack.
03B-10000	Brass	Spade Shelf Support, 5mm (332 BR)	1000
03B-10100	Chrome	Spade Shelf Support, 5mm (332 ANO)	1000
03B-10010	Brass	Spade Shelf Support, 7mm	1000
03B-10110	Chrome	Spade Shelf Support, 7mm	1000
03B-10011	Brass	Bushing, 7.5mm hole	1000
03B-10111	Chrome	Bushing, 7.5mm hole	1000



03B-10100

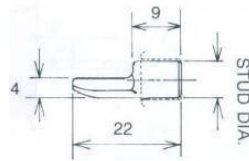

03B-10110

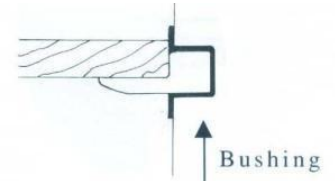

03B-10111

03B-11000	Bronze	Cylinder Shelf Pin, 5mm	1000
03B-11100	Chrome	Cylinder Shelf Pin, 5mm	1000



03B-20004	White	Locking Shelf Clip, 5mm x 3/4"	1000
03B-20008	Clear	Locking Shelf Clip, 5mm x 3/4"	5000
03B-20010	White	Locking Shelf Clip, 5mm x 5/8"	5000
03B-20011	Almond	Locking Shelf Clip, 5mm x 5/8"	5000
03B-20012	Clear	Locking Shelf Clip, 5mm x 5/8"	5000
03B-20020	Brown	Locking Shelf Clip, 5mm x 5/8"	1000
03B-20030	Clear	Locking Shelf Clip, 5mm x 5/8"	1000



03B-10031	Chrome	Shelf Support, Ano, 5mm	100
03B-10032	Chrome	Shelf Support, Ano, 1/4"	100
03B-20100	White	Plastic Shelf Clip, 5mm	1000
03B-20130	Clear	Plastic Shelf Clip, 5mm	1000
03B-20105	White	Shelf Clip, Metal Pin, 5mm	100/1000
03B-20136	Clear	Shelf Clip, Metal Pin, 5mm, B-Line	1000/5000



03B-10031

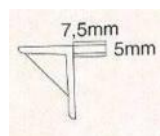

03B-20100



03B-20136

Shelf Standard & Brackets

Item #	Finish	Description	Pack.
03B-30018	Zinc	Steel Standard, KV255, 18" long	100
03B-30024	Zinc	Steel Standard, KV255, 24" long	100
03B-30030	Zinc	Steel Standard, KV255, 30" long	100
03B-30036	Zinc	Steel Standard, KV255, 36" long	100
03B-30048	Zinc	Steel Standard, KV255, 48" long	100
03B-30060	Zinc	Steel Standard, KV255, 60" long	100
03B-30072	Zinc	Steel Standard, KV255, 72" long	50
03B-30084	Zinc	Steel Standard, KV255, 84" long	50
03B-30096	Zinc	Steel Standard, KV255, 96" long	50
03B-30096-233	Zinc	Steel Standard, KV233, 96" long	50
03B-30596	Alum	Alum Standard, KV255, 96" long	50
03B-40000	Zinc	Shelf Clip, KV256	100/1000
03B-40003	Alum	Shelf Clip, KV256, Alum	100/1000
03B-40005	Zinc	Shelf Clip, KV237 (For KV233 only)	100/1000
03B-40010	Zinc	Shelf Clip, KV239	100/1000
03B-40015	Zinc	Shelf Clip with hole, KV 24276	100/1000
03B-40043	Zinc	Shelf Support, KV243 3" cross pc.	100/1000
03B-40100	White	Shelf Clip, KV256	100/1000

- standard KV255 is 5/8" wide x 3/16" high
- standard KV233 is 13/16" wide x 3/16" high (surface mount)
- adjustable on 1/2" centers
- other colours available on special order



KV 80 & 180 Standards & Brackets

Item #	Finish	Description	Pack.
03B-33024	Anochrome	KV 80 Standard Ano 24"	10
03B-33036	Anochrome	KV 80 Standard Ano 36"	10
03B-33048	Anochrome	KV 80 Standard Ano 48"	10
03B-33060	Anochrome	KV 80 Standard Ano 60"	10
03B-33072	Anochrome	KV 80 Standard Ano 72"	10
03B-33096	Anochrome	KV 80 Standard Ano 96"	10
03B-43004	Anochrome	KV 180 Bracket Ano 4"	10
03B-43006	Anochrome	KV 180 Bracket Ano 6"	10
03B-43008	Anochrome	KV 180 Bracket Ano 8"	10
03B-43010	Anochrome	KV 180 Bracket Ano 10"	10
03B-43012	Anochrome	KV 180 Bracket Ano 12"	10
03B-43014	Anochrome	KV 180 Bracket Ano 14"	10
03B-43016	Anochrome	KV 180 Bracket Ano 16"	10
03B-43018	Anochrome	KV 180 Bracket Ano 18"	10

- dimensions: 5/8" wide x 13/32" high
- 16 gauge steel construction
- adjustable on 1" centres

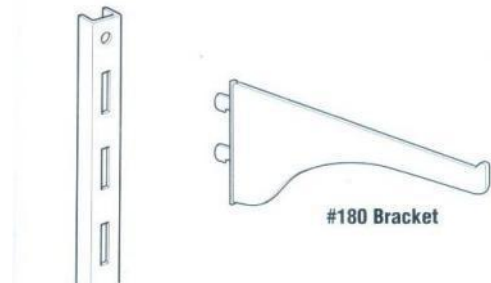

KV 85 & 185 Double Slot Standards & Brackets

Item #	Finish	Description	Pack.
03B-31072	Anochrome	KV85 Double Slot Ano 72"	10
03B-31084	Anochrome	KV85 Double Slot Ano 84"	10
03B-31096	Anochrome	KV85 Double Slot Ano 96"	10
03B-44012	Anochrome	KV185 Double Slot Ano 12"	10
03B-44018	Anochrome	KV185 Double Slot Ano 18"	10
03B-44024	Anochrome	KV185 Double Slot Ano 24"	10

- KV85 also available in 24", 36", 48" and 60" lengths
- KV185 also available in 8", 10", 14", 16", 20" and 22" lengths
- provides extra stability and load carrying capacity
- allow 4 weeks leadtime

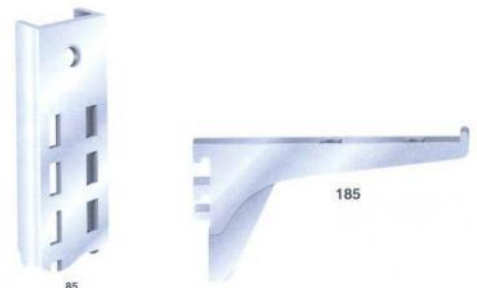

KV 87 & 187 Heavy Duty Standards & Brackets

Item #	Finish	Description	Pack.
03B-34048	Anochrome	KV87 XHD Standard 48"	5
03B-34072	Anochrome	KV87 XHD Standard 72"	5
03B-34096	Anochrome	KV87 XHD Standard 96"	5
03B-45008	Anochrome	KV186LL Bracket Ano 8"	10
03B-45010	Anochrome	KV186LL Bracket Ano 10"	10
03B-45012	Anochrome	KV187LL Bracket Ano 12"	10
03B-45014	Anochrome	KV187LL Bracket Ano 14"	10
03B-45016	Anochrome	KV187LL Bracket Ano 16"	10
03B-45018	Anochrome	KV187LL Bracket Ano 18"	10
03B-45020	Anochrome	KV187LL Bracket Ano 20"	10
03B-45022	Anochrome	KV187LL Bracket Ano 22"	10
03B-45024	Anochrome	KV187LL Bracket Ano 24"	10

- the 186/187 bracket includes a cam lock lever that quickly and firmly secures the bracket in place, to minimize the risk of disengagement
- also available in white
- allow 4 weeks lead time

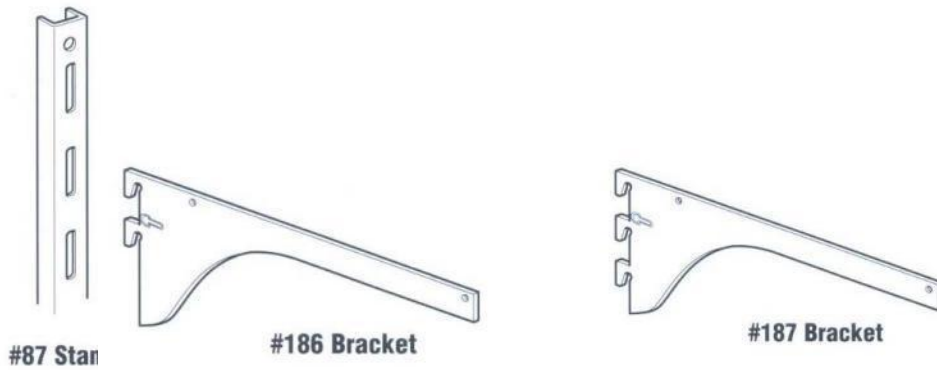

Stainless Steel 87/187 Standards & Brackets

Item #	Finish	Description	Pack.
03B-34524	Stainless	KV87 SS Standard XHD 24"	5
03B-34536	Stainless	KV87 SS Standard XHD 36"	5
03B-34548	Stainless	KV87 SS Standard XHD 48"	5
03B-34560	Stainless	KV87 SS Standard XHD 60"	5
03B-34572	Stainless	KV87 SS Standard XHD 72"	5
03B-45508	Stainless	KV186LL SS Bracket HD 8"	10
03B-45510	Stainless	KV186LL SS Bracket HD 10"	10
03B-45512	Stainless	KV187LL SS Bracket HD 12"	10
03B-45514	Stainless	KV187LL SS Bracket HD 14"	10
03B-45516	Stainless	KV187LL SS Bracket HD 16"	10
03B-45520	Stainless	KV187LL SS Bracket HD 20"	10
03B-45522	Stainless	KV187LL SS Bracket HD 22"	10
03B-45524	Stainless	KV187LL SS Bracket HD 24"	10

- allow 4 weeks lead time

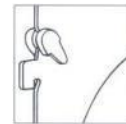

1987 Stainless Steel Shelving

Item #	Finish	Description	Pack.
03B-49508	Stainless	KV1987 SS Shelving 8" x 32"	5
03B-49510	Stainless	KV1987 SS Shelving 10" x 32"	5
03B-49512	Stainless	KV1987 SS Shelving 12" x 32"	5
03B-49514	Stainless	KV1987 SS Shelving 14" x 32"	5
03B-49516	Stainless	KV1987 SS Shelving 16" x 32"	5
03B-49520	Stainless	KV1987 SS Shelving 20" x 32"	5

- galvanized shelves also available in same sizes
- allow 4 weeks lead time

Brackets

Item #	Finish	Description	Pack.
03B-20230	White	KV208 Heavy Duty L-Bracket 11.8"	10
03B-20240	White	KV208 Heavy Duty L-Bracket 15.7"	10
03B-20250	White	KV208 Heavy Duty L-Bracket 19.6"	10
03B-20255	White	KV208 Heavy Duty L-Bracket 21.7"	10
03B-20630	Anochrome	KV206 Folding Bracket 12"	10
03B-20640	Anochrome	KV206 Folding Bracket 16"	10

Heavy Duty Bracket:

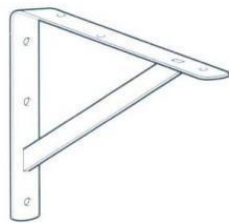

Folding Bracket:

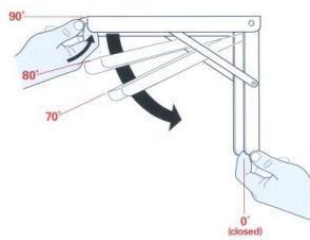

03B-71210	White	KV 215 Slim line 10"	10
03B-70217	White	KV 216 Simplicity 8"	10



Bumper Pads

Item #	Colour	Description	Pack.
03G-20000	Clear	Bumper Pad, 5mm push in	1000/10000
03G-20023	Clear	Bumper Pad, 7.9mm diam. x 2.2mm thick	450/5400
03G-20043	Clear	Flat Bumper Pad, 1/8" thick	200/5000
03G-20045	Clear	Flat Bumper Pad, 1/16" thick	200/5000
03G-20060	Clear	Quietex Pad, .40" diam., 1/10" thick	40/5000
03G-20100	Foam	Flat Bumper Pad, Hex	1000



03G-20000



03G-20023



03G-20043



03G-20060

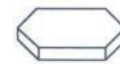

03G-20100

Closet Rods and Fittings

Round

Item #	Colour	Description	Pack.
03B-60096	Chrome	Closet Rod, 1-5/16" x 96"	10
03B-60210	Chrome	Closet Rod, 1" x 118"	10
03B-61000	Chrome	Closet Rod Flange, Closed (KV764) for 1-5/16"	12
03B-61010	Chrome	Closet Rod Flange, Open (KV766) for 1-5/16"	12
03B-61020	Chrome	Closet Rod Flange, Closed (KV734) for 1-1/16"	50
03B-61030	Chrome	Closet Rod Flange, Open (KV735) for 1-1/16"	50
03B-61040	Chrome	Flange Set (1 open, 1 closed) for 1-5/16"	20
03B-61300	Chrome	Flange, open for 1"	
03B-61310	Chrome	Flange, closed for 1"	
03B-65000	Zinc	Closet Rod, Adj. 18" - 30"	1/10
03B-65010	Zinc	Closet Rod, Adj. 30" - 48"	1/10

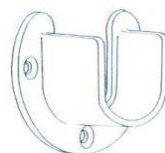
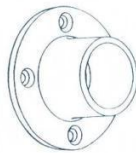

Oval

03B-62008	Chrome	Oval Closet Rod 96"	10
03B-62010	Chrome	Oval Rod Chrome 10'	10
03B-62010B	Black	Oval Rod Black 10'	10
03B-63010	Chrome	Oval Closet Rod Flange	16
03B-63010B	Black	Oval Closet Rod Flange	20
03B-63010H	Chrome	Oval Closet Rod Flange	200
03B-63100	White	Oval Closet Rod Flange (KV883)	50
03B-63011	Chrome	Oval Closet Rod Flange (Screw On)	100
03B-63011B	Black	Oval Closet Rod Flange (Screw On)	100
03B-64000	Chrome	Oval Closet Rod Support Center	100

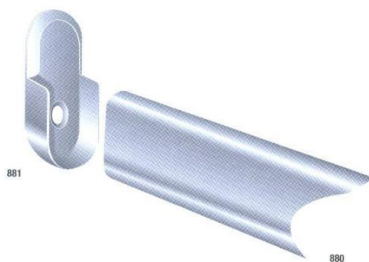

Catches and Latches

Item #	Colour	Description	Pack.
03C-10000	Brown	Magnetic Catch	100
03C-10002	White	Magnetic Catch	100
03C-10004	Black	Magnetic Catch	100
03C-10011	Stainless	Mag. Surface 40lb x 1"	1/12
03C-10012	Stainless	Mag. L/Brkt 40lb x 1"	1/12
03C-10013	Stainless	Mag. L/Brkt 20lb x ¾"	1/12
03C-10014	Stainless	Mag. L/Brkt 10lb x .5" (2 per package)	1/12
03C-10015	Stainless	Mag. Surface 20 lb x ¾"	1/12
03C-10100	Brown	Cylinder Magnet, 13mm	10
03C-10110	Black	Cylinder Magnet, 8mm	10

- strike plate sold separately



03C-10030	Brown	Double Magnetic Touch Latch	Each
03C-10032	White	Double Magnetic Touch Latch	Each
03C-10034	Black	Double Magnetic Touch Latch	Each
03C-10042	White	Single Magnetic Touch Latch	Each
03C-10044	Black	Single Magnetic Touch Latch	Each

- strike plate sold separately

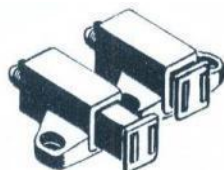

03C-20000	Zinc	Square Striker Plate	1000
03C-20001	Zinc	Oval Striker Plate	1000

- strike plate sold separately

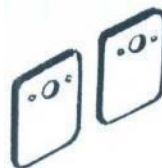

Catches and Latches

Item #	Finish	Description	Pack.
03C-10054	Bronze	Roller Catch	100
03C-10056	White/Chrome	Mini Touch Latch	25

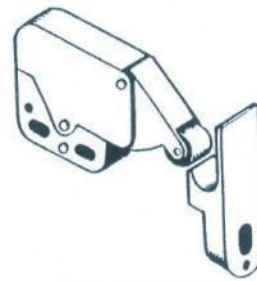
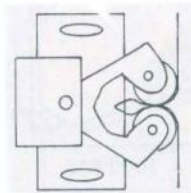

03C-10049	Zinc	Elbow Catch	Each
03C-10051	Chr. Plated Brass	Heavy Duty Elbow Catch	10

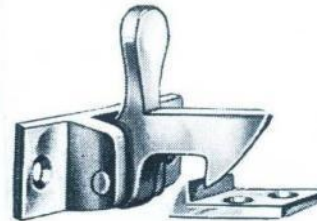

03C-10058	White	Flexa-Touch Drawer Latch	Each
-----------	-------	--------------------------	------

- mounted either on or through the drawer back
- releases and pushes the drawer open
- eliminates need for knobs and pulls

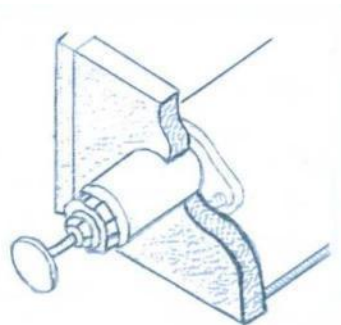

Catches and Latches

Item #	Finish	Description	Pack.
03C-10500	Brass	Ball Catch 3/8" x 1-15/16"	24
03C-10510	Brass	Ball Catch 7/16" x 2-5/16"	24
03C-10520	Brass	Ball Catch 1/2" x 2-3/4"	24

- solid brass
- double ball
- adjustable tension double spring

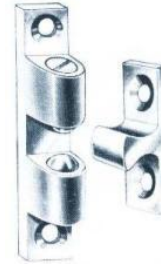

03C-10800	Chrome	Bullet Catch 3/8"long x 1/4" diam.	Each
03C-10810	Chrome	Bullet Catch 7/16" long x 5/16" diam.	Each
03C-10901	Brass look	Bullet Catch KV901 1/2"long x 3/8" diam	Each

- strike plate included
- spring loaded



03C-30000	Satin Nickel	Secret Gate Latch	10
-----------	--------------	-------------------	----

- reversible for left or right hand mounting
- dimensions are 2" x 2-3/8"

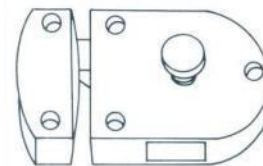

03C-32000	Zinc Plated	Barrel Bolt Zinc Plated 2"	1
03C-32050	Nickel Plated	Barrel Bolt Nickel Plated 50mm	1
03C-32070	Nickel Plated	Barrel Bolt Nickel Plated 70mm	1



Bed Fittings

Item #	Finish	Description	Pack.
03D-10000	Yellow Zinc	Bed Fitting Set (x4), Single Screw	10 sets
03D-10015	Zinc	Bed Fitting Screw Mounted	25 Sets

- item 03D-10000 sold in sets of 4 angle brackets with premounted screws and 4 flat receivers

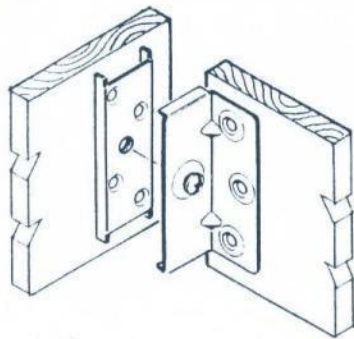

03D-10000

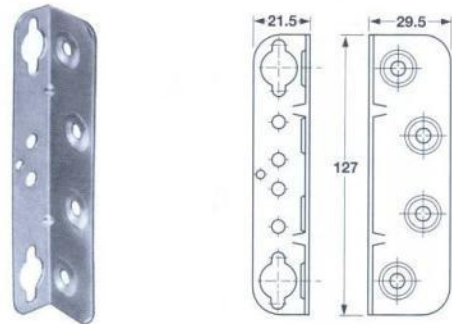

03D-10015

03D-10010	Zinc	Bed Fitting Set (x4), 95 mm	10 Sets
03D-10012	Zinc	Bed Fitting Set (x4), 160 mm	10 Sets

- sold in sets of 4 lefts and 4 rights
- uses #6 FH screws

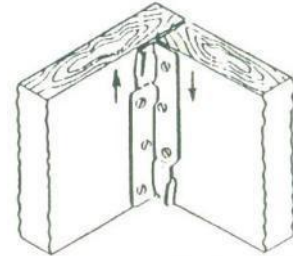

03D-10005	Yellow Zinc	Bed Fitting Set (x4), 3 Prong	12 Sets
-----------	-------------	-------------------------------	---------

- sold in sets of 4 hooks and 4 receivers
- uses #8 FH screws

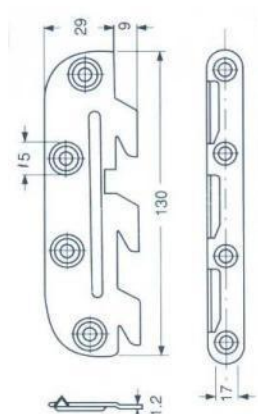

Assembly Fittings

Item #	Finish	Description	Pack.
03D-10030	Plain	"L" Bracket, 3/4" x 3/4" x 3/4", 18 g.	2500
03D-10030M	Plated	"L" Bracket, 7/8" x 7/8" x 1/2"	
03D-10031	Plain Steel	"L" Bracket, 1 hole 11 g.	2000
03D-10034	Plain Steel	"L" Bracket, 1" x 1" x 1-1/2", (4 hole)	100
03D-10036	Plain Steel	"L" Bracket, 1-1/2" x 1-1/2" x 1-1/2"	200
03D-10037	Plain Steel	"L" Bracket, 1 x 1 x 5/8", 11 g.	2000
03D-10038	Galvanized	"L" Bracket, 1 x 1 x 1-3/4" (6 hole)	800
03D-10040	Galvanized	Universal Bracket	100
03D-10050	Brown	Plastic Bracket 3/4" x 3/4" x 3/4"	100
03D-10052	White	Plastic Bracket 3/4" x 3/4" x 2"	100
03D-10053	Black	Plastic Bracket 3/4" x 3/4" x 2"	100
03D-10054	Black	Plastic Bracket 3/4" x 3/4" x 5"	100
03D-10057	Natural	Plastic Glue Bracket 3/4" x 3/4" x 2"	100

• other steel brackets available to special order



03D-10030



03D-10034



03D-10036



03D-10040

03D-10055	White	Corner Brace with cover	100
03D-10056	White	Kolbe Korner - White Plastic	100



03D-10055

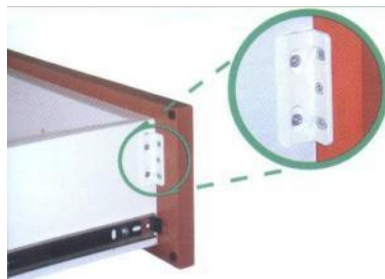

03D-10056

03D-10104	Zinc	Steel Mending Plate 3/4" x 4" - 12 g.	500
-----------	------	---------------------------------------	-----

• other mending plates available to special order

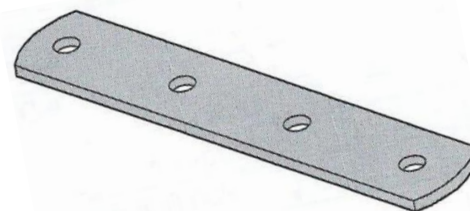

Assembly Fittings

Item #	Description	Size	Pack.
03D-10060	Single Hole,	19/32" x 1-3/4"	Each
03D-10062	Two Hole,	19/32" x 3"	Each

- countersunk for #6 screws

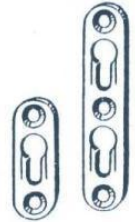

03D-10200	Lamello Biscuit #0	47 x 15 x 4mm	1000
03D-10210	Lamello Biscuit #10	53 x 19 x 4mm	1000
03D-10220	Lamello Biscuit #20	56 x 23 x 4mm	1000

- top quality biscuit by Lamello (made in Switzerland)



03D-10230	Fluted Dowel, 6mm x 30mm	1000
03D-10240	Fluted Dowel, 6mm x 40mm	1000
03D-10330	Fluted Dowel, 8mm x 30mm	1000
03D-10335	Fluted Dowel, 8mm x 35mm	1000
03D-10340	Fluted Dowel, 8mm x 40mm	1000
03D-10345	Fluted Dowel, 8mm x 45mm	1000
03D-10350	Fluted Dowel, 8mm x 50mm	1000
03D-10440	Fluted Dowel, 10mm x 40mm	1000
03D-10450	Fluted Dowel, 10mm x 50mm	1000
03D-10724	Fluted Dowel, 7/16" x 1-1/2"	1000
03D-18830	Fluted Dowel Pre-Glued, 8mm x 30mm	1000

- other sizes of dowels are available by special order and minimum quantity will apply.



Assembly Fittings

Item #	Finish	Description	Pack.
03D-20202	Zinc	Taper Connector 2"	Set
03D-20204	Zinc	Taper Connector 4"	Set
03D-20206	Zinc	Taper Connector 6"	Set

- wedge shaped fasteners for connecting beds, chair parts and for hanging wall cabinets, etc.
- locks tight with pressure
- provides a strong joint

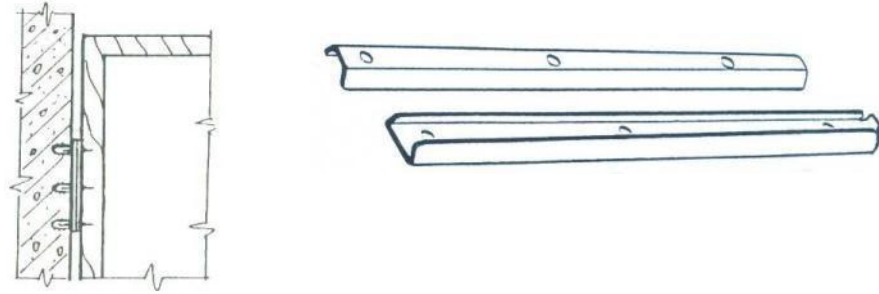

03D-40100	Zinc	Joint Fastener	100
-----------	------	----------------	-----

- 3-½" long bolt with flat bar plates (7/16" x 3/16" x 1-¼")



03D-40225	Zinc	Tite Joint Fastener	25
-----------	------	---------------------	----

- KV 516 fasteners apply an even controlled pressure between joint members, eliminating twisting and buckling.
- designed for ¾" wood
- centre to centre is 2" to 3-½"



03D-40300	Zinc	Flipbolt	50
03D-40350	Zinc	Zipbolt	50
03D-40355	Zinc	Zipbolt Driver	1

- tool-less countertop connector

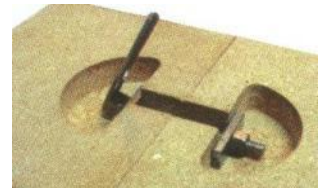

Assembly Fittings

Item #	Colour	Description	Pack.
03D-30000	White	Interscrew Nut	100
03D-30010	White	Interscrew Bolt for two 3/4" gables	100
03D-30020	White	Interscrew Bolt for two 5/8" gables	100

- use interscrew to fasten adjacent cabinet gables together



03D-30052	Brown	Drawer Front Adjuster, 25mm (TT6309)	100
-----------	-------	--------------------------------------	-----

- use Drawer Front Adjusters to allow for precise adjustment of drawers against false fronts
- supplied with 1" x 8x32 machine screws

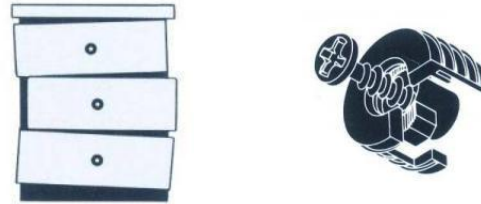

Connector Cams and Dowels

Item #	Colour	Description	Pack.
03D-23021	White	Housing Assembly full depth	2500
03D-23100	Zinc	Screw Dowel	2500



Sink Front Clips

Item #	Colour	Description	Pack.
03D-40000	Steel	Sink Front Spring Clip	1000
03D-40050	Zinc	Sink Front Dowel 5mm	10000
03D-40055	Black	Keku Sink Front Clip Screw-On	1000
03D-40056	Black	Keku Sink Front Clip E/S	1000

- for fastening panels to frames

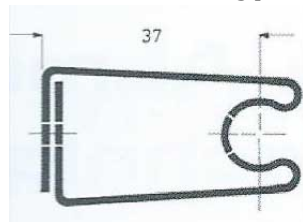

03D-40000



03D-40050

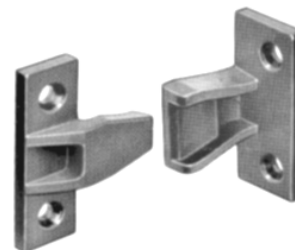

03D-40055

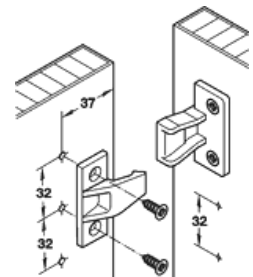

Turntables and Swivels

Item #	Colour	Description	Pack.
03E-20004	Steel	4" Square Swivel, 300lb capacity	Each
03E-20006	Steel	6" Square Swivel, 300lb capacity	Each
03E-20100	Steel	6" Chair Swivel	Each
03E-20009	Zinc	9" Round Swivel, 850lb capacity	1/25
03D-20012	Steel	12" Round Swivel, 850lb capacity	1/25

- overall size 3-5/8"

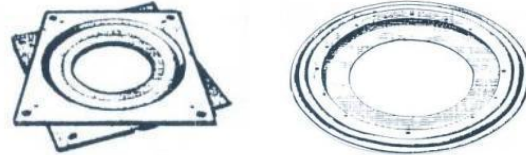

Desk Grommets

Item #	Colour	Description	Pack.
03F-20100	Brown	Plastic Grommet, 60 mm	50
03F-20101	White	Plastic Grommet, 60 mm	50
03F-20102	Black	Plastic Grommet, 60 mm	50
03F-20103	Almond	Plastic Grommet, 60 mm	50
03F-20104	Grey	Plastic Grommet, 60 mm	50
03F-20120	Brown	Plastic Grommet, 80 mm	50
03F-20121	White	Plastic Grommet, 80 mm	50
03F-20122	Black	Plastic Grommet, 80 mm	50
03F-20123	Almond	Plastic Grommet, 80 mm	50
03F-20124	Grey	Plastic Grommet, 80 mm	50



- drilled hole size in substrate is 60 & 80mm

03F-20130	Brown	Plastic Grommet, 1"	25/500
03F-20131	White	Plastic Grommet, 1"	25/500
03F-20132	Black	Plastic Grommet, 1"	25/500
03F-20134	Grey	Plastic Grommet, 1"	25/500
03F-20140	Brown	Plastic Grommet, 1-3/4"	25/500
03F-20142	Black	Plastic Grommet, 1-3/4"	25/500
03F-20144	Grey	Plastic Grommet, 1-3/4"	25/500
03F-20110	Brown	Plastic Grommet, 2-1/2"	25/500
03F-20111	White	Plastic Grommet, 2-1/2"	25/500
03F-20112	Black	Plastic Grommet, 2-1/2"	25/500
03F-20113	Almond	Plastic Grommet, 2-1/2"	25/500
03F-20114	Grey	Plastic Grommet, 2-1/2"	25/500
03F-20115	Charcoal	Plastic Grommet, 2-1/2"	25/500
03F-20000	Brass Plated	Metal Grommet, 2 pcs., 2-1/2"	150
03F-20010	Chr. Plated	Metal Grommet, 2 pcs., 2-1/2"	150

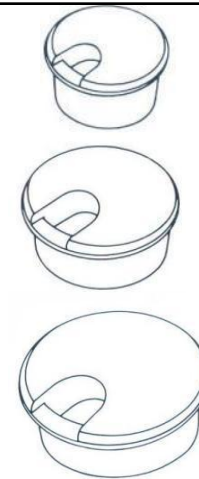

- drilled hole size in substrate is 1", 1-3/4" & 2-1/2"
- grommet opening is 13/16", 1-5/8" & 2-1/4"
- depth is 5/8"

Desk Grommets

Item #	Colour	Description	Pack.
03F-20220	Black	Plastic Paper Grommet	100
03F-20232	Black	Plastic Oval Desk Grommet	25
03F-20234	Grey	Plastic Oval Desk Grommet	25
03F-20300	Black	Grommet/Pencil Holder	10
03F-20312	Black	Plastic Grommet Rectangular	300

- paper grommet dimensions - 40mm x 305mm
- machined hole size in substrate for oval grommet is 1-3/4" x 3-1/4"
(available in 4 other colours to special order)



03F-20220



03F-20232



03F-20300

03F-20241	White	Plastic Liner, 6"	Each
03F-20242	Black	Plastic Liner, 6"	Each



Vent Grill

Item #	Colour	Description	Pack.
03F-20500	Black	Vent Grill - Black	10
03F-20510	Grey	Vent Grill - Grey	10
03F-20520	White	Vent Grill - White	10
03F-20600	Black	Vent Grill - 2-1/2" diam	10

- overall size 3-5/8" x 9-5/8"
- substrate cut out 2-5/8" x 8-5/8"

Corner Shelf Support (3/4")

Item #	Colour	Description	Pack.
03B-20140	White	14" Corner Support - White	1/100
03B-20141	Brown	14" Corner Support - Brown	1/100
03B-20142	Almond	14" Corner Support - Almond	1/100
03B-20150	White	16" Corner Support - White	1/100
03B-20151	Brown	16" Corner Support - Brown	1/100
03B-20152	Almond	16" Corner Support - Almond	1/100
03B-20153	Black	16" Corner Support - Black	1/100
03B-20154	Silver	16" Corner Support - Silver	1/100

File Holders / Drawer Divider Clips

Item #	Colour	Description	Pack.
03F-40002	Black	Hanging file bar holder	100/4000
03F-40012	Black	Screw mounted file bar holder	100/4000
03F-40210	Alum.	File bar 1/8" x 1/2"	12' length

- hanging file bar holders are for drawer sides 7/16" to 1/2" thick

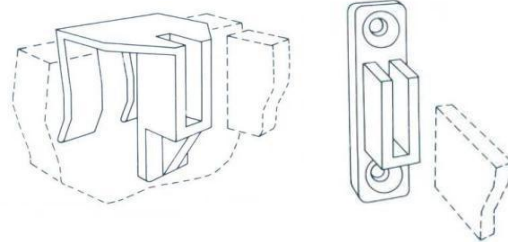

03F-40022	Black	File bar holder - 90°	100/4000
-----------	-------	-----------------------	----------

- fits over file bar allowing for custom sizing

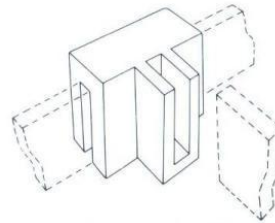

03F-40112	Black	Drawer divider clip	100
03F-40122	Black	Drawer divider clip (short)	100
03F-40132	Black	Drawer divider clip (long)	100

- one model best for shallow drawers, the other for deep drawers
- hangs on drawer sides 7/16" to 1/2" thick
- fits 1/4" thick dividers

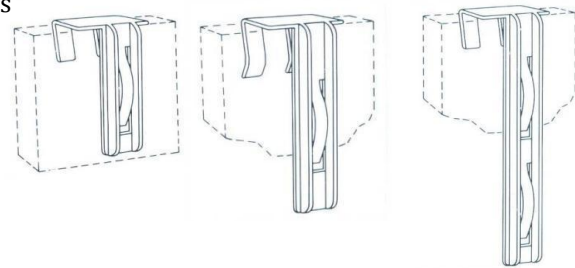

Pencil Trays

Item #	Colour	Description	Pack.
03F-10000	Black	Single Pencil Tray, 12-7/8" x 3"	120
03F-10005	Black	Single Pencil Tray, 12-5/16" x 3-1/8"	120
03F-10010	Black	Double Pencil Tray, 12-7/8" x 5-5/8"	40

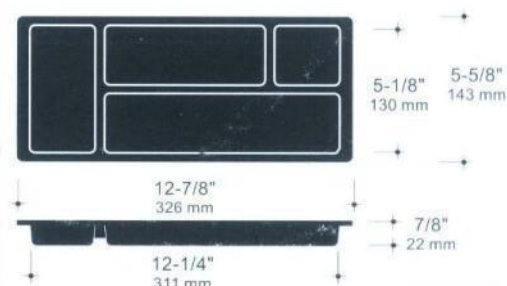
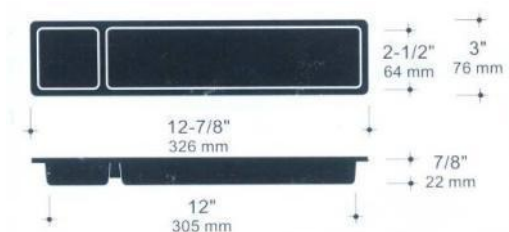
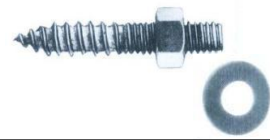
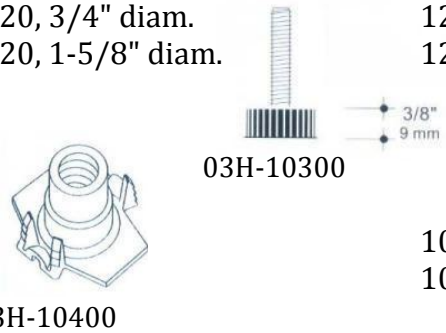

Table Hardware

Item #	Finish	Description	Pack.
13L-50110	Plain Steel	Hanger Bolt, 5/16" x 3"	1000
13L-50112	Plain Steel	Hanger Bolt, 5/16" x 3-1/2"	700
13L-52110	Plain Steel	Hex Nut 5/16"	500
13L-51110	Plain Steel	Washer 5/16"	500



03H-10300	Black	Plastic Leg Leveller, 5/16"-18, 7/8" diam.	1250
03H-10307	Black	Plastic Leg Leveller, 1/4"-20, 3/4" diam.	1250
03H-10311	Black	Plastic Leg Leveller, 1/4"-20, 1-5/8" diam.	1250
03H-10400	Plain Steel	T Nut, 5/16"-18	1000
03H-10414	Plain Steel	T Nut, 1/4"-20	1000



03H-10500	Brown	Plastic Table Top Leveller (M & F)	50
-----------	-------	------------------------------------	----

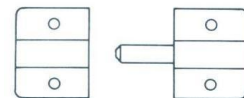

03H-10210	Plain Steel	"Z" Clip Skirt Fastener, 1/2" Offset	50
-----------	-------------	--------------------------------------	----



03H-10550	Brass Plated	Sash Table Locks	25
-----------	--------------	------------------	----

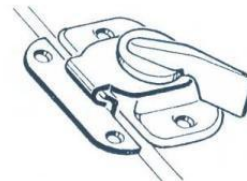

07C-20361	Brass Plated	Restaurant Table Hinge	Each
-----------	--------------	------------------------	------

- extension flaps fold flat under table top
- open 180° to provide secure extension
- use on the 4 sides of a square table to make a round table
- use on the ends of a rectangle table to lengthen
- automatically locks in both open and closed positions

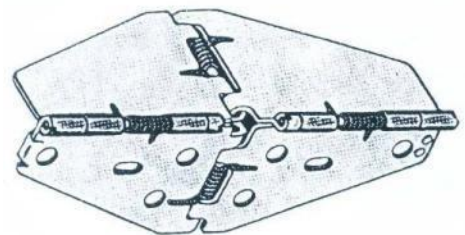

Table Legs

Item #	Finish	Description	Pack.
03H-40000	Chrome	Adj. Leg 60mm x 710mm	4
03H-40002	Black	Adj. Leg 50mm x 710mm	4
03H-40200	Chrome	Adj. Leg 60mm x 710mm	4
03H-40202	Black	Adj. Leg 60mm x 710mm	4
03H-41200	Chrome	Adj. Leg 76mm x 710mm	4



Furniture and Cabinet Legs

Item #	Colour	Description	Pack.
03H-42000	Dull Nickel	Furniture Leg Dull Nickel	1
03J-20000	Black	Adjustable Cabinet Legs (sets of 4)	1/40



Casters

Item #	Finish	Description	Pack.
03A-10020	Black	Plate Caster	Each
03A-10120	Black	Plate Caster/ With Brake	Each
03A-20020	Black	Stem Caster	Each
03A-20120	Black	Stem Caster / With Brake	Each
03A-30020	Black	Threaded Caster, 50mm, 5/16-18	Each
03A-30120	Black	Threaded Caster/ With Brake	Each

- casters also available threaded in ¼-20
- size: 50mm
- T-nut and insert nuts are stocked for 5/16-18" thread (¼-20 available to special order)
- other colors available to special order

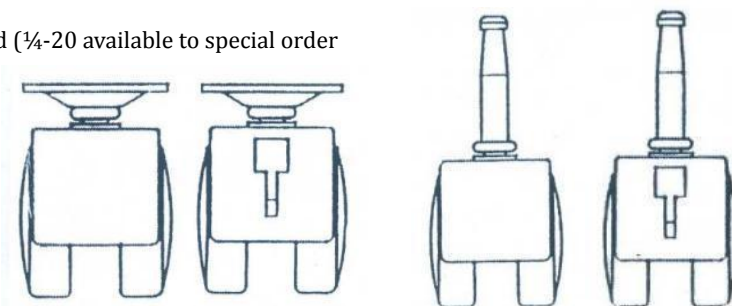

Miscellaneous

Item #	Colour	Description	Pack.
03G-10000	White	Nail glide, 5/8" diam.	1000
03G-10010	White	Nail glide, 3/4" diam.	1000



03G-30010		Retaining clip, 1/8" recess	1000
03G-30020	Brown	Retaining clip, 1/4" recess	1000
03G-31000	Bronze	Retaining bracket, adjustable	200
03G-32000	Clear	Retaining clip (glass stop)	1000
03G-32100	Clear	Retaining clip	1000



03G-30020



03G-31000



03G-32000



03G-32100

03G-60000	Brown	Flap Stay	Each
03G-60001	Beige	Flap Stay	Each
03G-60002	White	Flap Stay	Each
03G-61000	Zinc	Lid/Flap Stay - 6kg	Each
03G-61001	Ni-Plated	Cab. mounting bracket	Each
03G-61002	Ni-Plated	Door mounting bracket	Each



03G-50000	Chrome	Coat hook	20/240
03G-50002	ORB	Coat hook - 3 way oil rubbed bronze	25
03G-50003	Satin Nickel	Coat hook - 3 way satin nickel	25
03G-50010	Anochrome	Coat hook KV1132-6"	12

- many other styles and finishes available to special order



03G-50000



03G-50002



03G-50010

Closet Accessories



Premier Closet Mirror
03B-67804

Section 4 • Veneers & Tambours

Table of Contents

Sheet Veneer	Page 4.1
Tambour Door Kits	Page 4.4

For a complete list of veneers, backers and sizes available,
see the Multiflex website. www.placagesmultiflex.com

Does the name Pavlov ring a bell?

General Information

Appearance of Individual Pieces of Veneer

Veneer Cuts

The way in which a log is cut in relation to the annual rings determines the appearance of veneer. The beauty of veneer is in the natural variations of texture, grain, figure, color and the way it is assembled on a door face.

Faces will have the natural variations in grain inherent in the species and cut. Natural variations of veneer grain and pattern will vary from these illustrations.

These are representative drawings of real wood veneers. Involve your woodworker early in the design and selection process.

Flat Cut (Plain Sliced)

Slicing is done parallel to a line through the center of the log. Cathedral and straight grained patterns result. The individual pieces of veneer are kept in the order they are sliced, permitting a natural grain progression when assembled as veneer faces.

Quarter Cut

A series of stripes is produced. These stripes vary in width from species to species. A natural distribution of ray fleck (flake) is a characteristic of this cut in red and white oak.

Rift Cut

The cut slices slightly across the medullary rays, accentuating the vertical grain and minimizing the "fleck." Rift grain is restricted to red and white oak.

Comb Grain

Limited availability. This is a rift cut veneer distinguished by the tightness and straightness of the grain along the entire length of the veneer. Slight angle in the grain is allowed. Comb grain is restricted to red and white oak. There are occasional cross bars and fleck is minimal.

Rotary

This cut follows the log's annual growth rings, providing a generally bold random appearance.

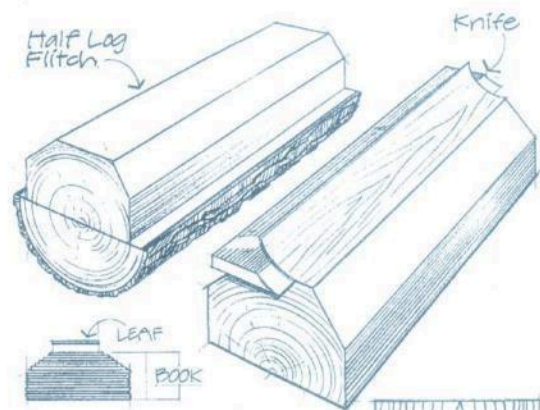

Plain Sliced Or Flat Sliced (slicer)

Leaf width depends on log size & placement in flitch.
Half Round. A somewhat similar pattern is achieved by turning a half log flitch on a lathe.



Flat Cut: Plain Sliced Quarterlog Flitch

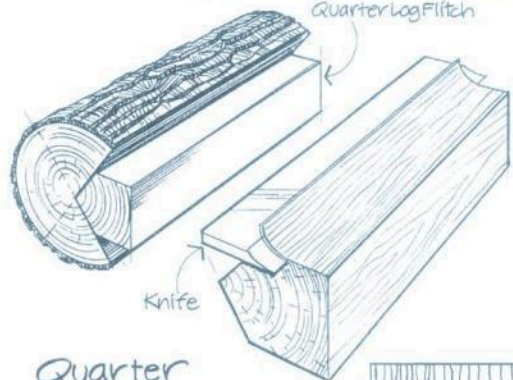

Quarter Sliced (slicer)

Flake pattern is produced when slicing through Medullary Rays in some species, principally oak.

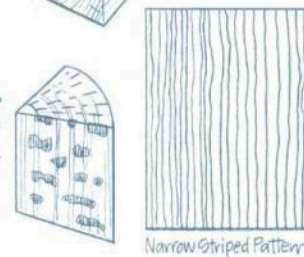

Quarter Cut Red and White Oak

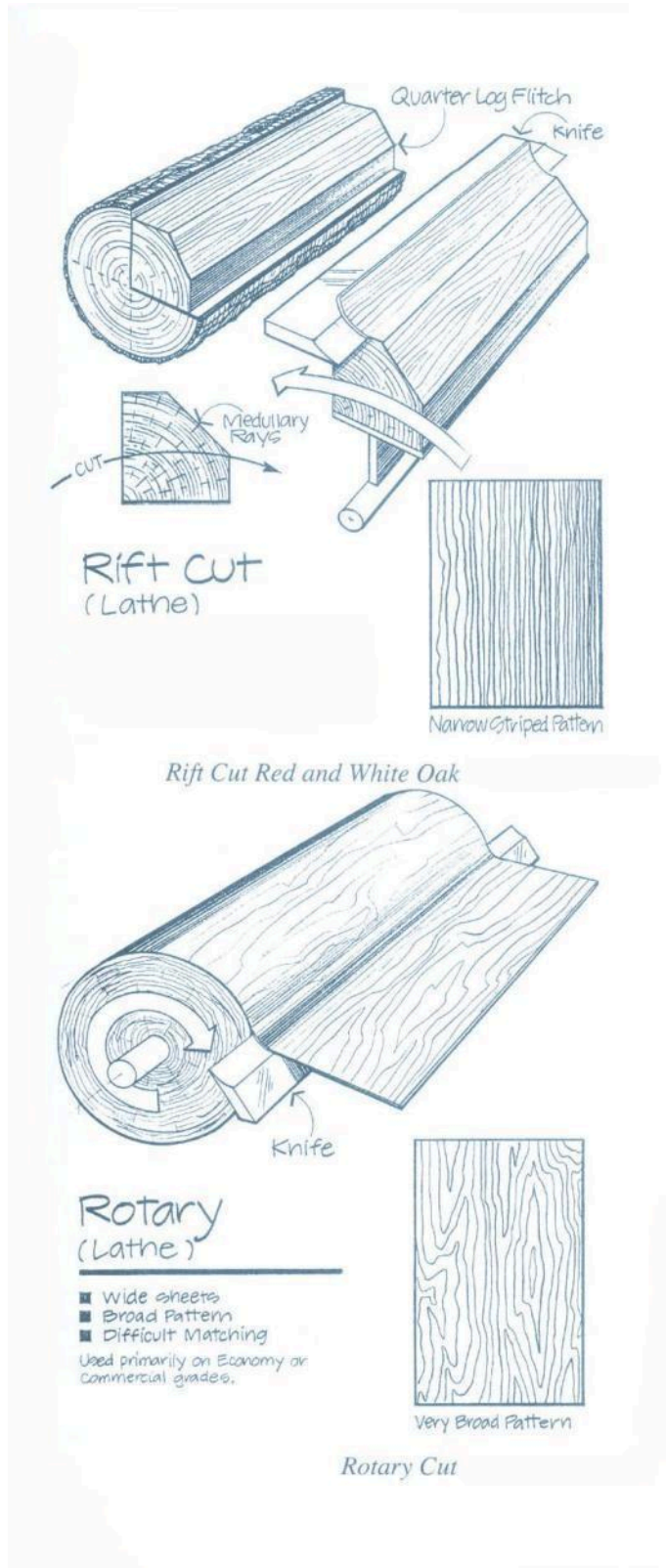

Wood Veneer Sheets

Item #	Description	Size
Veneer with self-adhesive backer		
04A-11828	Flat Cut Maple self-adhesive	24" x 96"
04A-13828	Flat Cut Red Oak self-adhesive	24" x 96"
04A-17828	Flat Cut Cherry self-adhesive	24" x 96"
Veneer with 10mil paper back (inquire re: 5mil and 20mil paperback)		
04B-10048	Rotary Cut White Birch	48" x 96"
04B-11140	Flat Cut Maple	48" x 120"
04B-11148	Flat Cut Maple	48" x 96"
04B-12148	Flat Cut Mahogany	49" x 96"
04B-13140	Flat Cut Red Oak	48" x 120"
04B-13148	Flat Cut Red Oak	48" x 96"
04B-14048	Clear Pine	48" x 96"
04B-15148	Flat Cut Knotty Pine	48" x 96"
04B-16248	Rift Cut White Oak	48" x 96"
04B-17148	Flat Cut Cherry	48" x 96"
04B-18148	V.G. Fir	48" x 96"
04B-19148	Flat Cut Hickory	48" x 96"
04B-20148	Flat Cut Walnut	48" x 96"
04B-21148	Flat Cut Red Alder	48" x 96"
04B-22148	Flat Cut Knotty Alder	48" x 96"
Veneer with X-grain wood back		
04D-11148	Flat Cut Maple	48" x 96"
04D-18148	V.G. Fir	48" x 96"
Veneer with polyback		
04F-10048	Rotary Cut Birch Polyback	48" x 96"
04F-11140	Flat Cut Maple Polyback	48" x 120"
04F-11148	Flat Cut Maple Polyback	48" x 96"
04F-11340	Quart Cut Maple Polyback	48" x 120"
04F-11348	Quart Cut Maple Polyback	48" x 96"
04F-13140	Flat Cut Red Oak Polyback	48" x 120"
04F-13148	Flat Cut Red Oak Polyback	48" x 96"
04F-16148	Flat Cut White Oak Polyback	48" x 96"
04F-16248	Rift Cut White Oak Polyback	48" x 96"
04F-16240	Rift Cut White Oak Polyback	48" x 120"
04F-17140	Flat Cut Cherry Polyback	48" x 120"
04F-17148	Flat Cut Cherry Polyback	48" x 96"
04F-18148	Flat Cut V.G. Fir Polyback	48" x 96"
04F-21148	Flat Cut Red Alder Polyback	48" x 96"
04F-21140	Flat Cut Red Alder Polyback	48" x 120"

- other veneers and sizes available upon request

For more information on our veneers, please visit www.placagesmultiflex.com

Tambour Door Kits - For Face Frame Cabinets

Includes quality tambour door with handpull and spring tension tambour track system, packed together in a carton. Track system consists of two PVC guide rails, wood dowels, donut(s), and tension spring.

Item #	Description	Width	Height
04C-15301	Combination Kit Red Oak V-3	15"	18"
04C-15303	Combination Kit Cherry V-3	15"	18"
04C-15307	Combination Kit Maple V-3	15"	18"
04C-24301	Combination Kit Red Oak V-3	24"	18"
04C-24303	Combination Kit Cherry V-3	24"	18"
04C-24307	Combination Kit Maple V-3	24"	18"
04C-30301	Combination Kit Red Oak V-3	30"	18"
04C-30303	Combination Kit Cherry V-3	30"	18"

- available for frameless on special order
- also available in hickory
- track system: white or almond

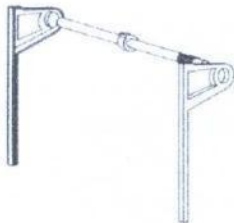

Track System ST-2
(Face Frame Mounting)

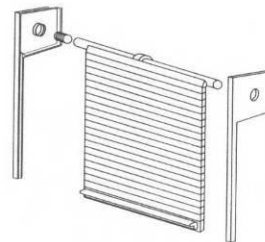

Track System ST-3
(Frameless Style Mounting)

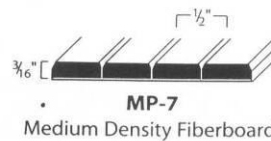
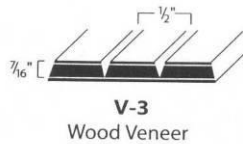

Section 5 • Edgebanding & Mouldings

Table of Contents

PVC Solid Colours	Page 5.1
PVC Woodgrains	Page 5.2
Thick PVC	Page 5.3
Wood Veneer Edgebanding	Page 5.4
Melamine Edgebanding	Page 5.5
Peel and Stick Edgebanding	Page 5.6
Speedtape	Page 5.7
Plastic Mouldings	Page 5.7



A boiled egg in the morning is hard to beat.

PVC Solid Colours

Standard roll size = 1200 lineal ft., *except* 1-1/8" = 1100 lineal ft.

Code	Colour	Widths in Stock (x)			
		5/8	3/4	7/8	1-1/8
05A-10014TE	White 7001	x	x	x	
05A-20014	Almond 427			x	
05P-05515	Dove Grey			x	
05A-31014	Silver Grey 480			x	
05A-40014	Black			x	
05B-00912	Paintable		x	x	
05B-11014	Black high gloss			x	x
05B-13014	White high gloss 1501			x	
05B-14014	Antique White 119			x	
05B-50014	French Grey			x	
05B-51014	Pavillion			x	
05B-52014	Latte			x	

- other colours, widths and gauges are available on special order.
- minimum for special order = 2 boxes

Please refer to Section 2 for suitable adhesives.

PVC Woodgrains

Standard roll size = 1200 lineal ft.

Code	Colour	Widths in Stock (x)		
		3/4	7/8	1-1/8"
05C-11014	Wood Maple 2284			x
05C-27014	Nightfall 1540			x
05C-31014	Pecan 7558			x
05C-32014	Zambukka			x
05C-39014	Toteda on Maple			x
05C-40014	Laredo Oak			x
05C-55014	Spice on Maple			x
05C-57014	Riviera Maple 1717			x
05C-65014	Brindel on Maple 1696			x
05C-69014	Chestnut 1595	x		x
05C-76014	Cognac on Maple 2397			x
05C-78014	Java on Alder 1474			x
05C-81014	Queenston Oak			x
05C-82014	Aria Maple			x
05C-84014	Britannic 7547			x
05C-85014	Brandy 7548			x
05C-87014	H.R. Maple 1138			x
05C-88014	Brown Pearwood 1230			x
05C-89014	Amber Maple 1284			x
05C-92014	Chocolate Peartree 1531			x
05C-94012	Mont. Maple 1000			x
05C-96014	Mocha 1639	x		
05C-97014	Harvest Oak 2011			x

- all other patterns are available on special order. Minimum for special order = 2 boxes

2mm Thick PVC Edgebanding (1-3/16" wide)

- 300' per roll

Code	Colour	Match to
Woodgrains		
05D-27219	Night Fall	Panolam W292
05D-32219	Zambukka	Flakeboard WF226
Solid Colours		
05D-02219	White	
05D-31219	Silver Grey	
05D-40219	Black	

2mm Thick PVC Edgebanding

- 300' per roll

Code	Colour	Size
Woodgrains		
05D-39215HR	Hardrock Maple	2mm x 15/16"
Solid Colours		
05D-02214	White	2mm x 7/8"

Thick PVC Edgebanding (1mm)

Code	Colour	Match to
05D-02114	White 7/8"	W200
05D-40114	Black 7/8"	
05D-39114	Hard Rock Maple 7/8"	
05D-88114	Brown Pearwood 7/8"	Panolam W340

Real Wood Edgebanding (Thick)

Code	Thickness	Species	7/8	15/16
1mm				
05E-30715-1.0	1mm	Alder		x
05E-30915-1.0	1mm	Beech		x
05E-31015-1.0	1mm	Birch		x
05E-31115-1.0	1mm	Maple		x
05E-31215-1.0	1mm	White Oak		x
05E-31315-1.0	1mm	Red Oak		x
05E-31415-1.0	1mm	Walnut		x
05E-31815-1.0	1mm	Fir		x
1.5mm				
05E-30714-1.5	1.5mm	Alder	x	
05E-31114-1.5	1.5mm	Maple	x	
05E-31214-1.5	1.5mm	White Oak	x	
05E-31314-1.5	1.5mm	Red Oak	x	
05E-31414-1.5	1.5mm	Walnut	x	
05E-31614-1.5	1.5mm	Mahogany	x	
2mm				
05E-31014-2.0	2mm	Birch	x	
05E-31114-2.0	2mm	Maple	x	
05E-31214-2.0	2mm	White Oak	x	
05E-31314-2.0	2mm	Red Oak	x	
05E-31414-2.0	2mm	Walnut	x	
05E-31714-2.0	2mm	Cherry	x	
3mm				
05E-30514	3mm	Wenge	x	
05E-30714	3mm	Alder	x	
05E-30914	3mm	Beech	x	
05E-31714	3mm	Cherry	x	
05E-31914	3mm	Hickory	x	

- rolls are 328 lineal feet (100 meters)
- other widths and thicknesses are available on special order

Wood Veener Edgebanding

Species	3/4	7/8	1-1/8	1-3/4
Unglued (500 ft per roll)				
Alder	x	x	x	
Birch White		x	x	
Birch White Prefinished		x		
Cherry	x		x	
Cherry Prefinished		x		
Fir		x		
Hickory		x		
Mahogany		x		
Maple	x	x	x	x
Maple Prefinished	x	x		
Pine		x		
Red Oak		x	x	
Red Oak Prefinished		x		
Steamed Beech		x		
Walnut		x		x
Wenge		x		
Wenge (Recon)		x		
White Oak Rift		x		
Preglued (250 ft per roll)				
Alder		x		
Birch White		x		
Birch White Prefinished		x		
Cherry		x		
Cherry Prefinished		x		
Fir		x		
Mahogany		x		x
Maple		x		x
Maple Prefinished		x		
Pine		x		
Red Oak		x		x
Red Oak Prefinished		x		
Walnut		x		
White Oak		x		

- other species and widths are available on special order (minimum 1 roll) example - picture below
- all unglued veneers are fleece backed and double sanded, preglued are touch sanded



Melamine Edgebanding (Iron-on)

Preglued for hot iron edgebanders. All stocked in 7/8" width rolls.

Solid Colors		Wood Grains
Winter White	Almond	Hardrock Maple
Antique White	Black	Maple (Mel)
Light Grey	Dark Grey	

- other colours and widths are available on special order.
- allow 1-2 weeks for delivery.
- minimum special order= 5 rolls (250'/roll)

Peel and Stick Edgebanding

Item #	Finish	Description	Quantity
05H-01914E	White	White 7/8"	52'
05H-02914	Antique White	Fastedge Antique White 7/8"	50'
05H-03914	Almond	Fastedge Almond 7/8"	50'
05H-04914	Black	Fastedge Black 7/8"	50'
05H-05914	Fog Grey	Fastedge Fog Grey 7/8"	50'
05H-06914	Folkstone Grey	Fastedge Folkstone Grey 7/8"	50'
05H-10914E	Birch PF	Ven. Birch Prefinished 7/8"	50'
05H-11914E	Birch	Ven. Birch 7/8"	50'
05H-13914	Red Oak	Ven. Red Oak 7/8"	50'
05H-14914	Maple	Fastedge Maple 7/8"	50'
05H-14914PFMaplePF		Fastedge Maple Pre-Finished 7/8"	50'

- peel and stick edgebanding
- perfect solution for field repairs, inside and outside radiuses
- made from high quality PVC and real wood veneers
- available in widths up to 5"

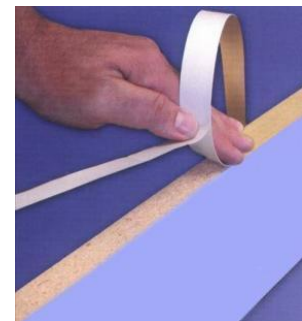

Speedtape

Item #	Description	Quantity
05H-30000	Speedtape 1" x 50'	1

- double sided PSA adhesive in a peel and stick roll
- Strengthens as it cures
- great for edgebanding laminate



Section 6 • Decorative Hardware

Table of Contents

Cabinet Pulls

Bow Pulls	Page 6.1
D Pulls	Page 6.1
Gallery Rail	Page 6.2
Aluminum	Page 6.2
Designer Series	Page 6.3



Cabinet Knobs	Page 6.8
----------------------	----------









The selection of pulls and knobs is virtually limitless.
For a greater selection, visit our website.





Cabinet Pulls - Bow Pull

	Item #	Finishes:	c.c.	Overall	Price
	06A-41000	Satin Nickel	96mm	118mm	
	PC 128	Antique Copper, Black Black Nickel, Br. Ant. Nickel Dark Pewter, Natural Iron Polished Brass, Polished Chrome, Satin Chrome	128mm	159mm	\$2.72
	PC 224	Black, Brushed Nickel Satin Chrome	224mm	290mm	\$9.38

Cabinet Pulls - D Pull



	Item #	Finishes:	c.c.	Overall	Price
Industrial D Pull					
	06A-31010	Polished Brass	4"	4.25"	
Wire D Pull					
	06A-40638	Matte Black	76mm	83mm	
	06A-40800	Brushed Nickel (8mm diam.)	96mm	103mm	
	06A-40810	Brushed Nickel (10mm diam.)	96mm	106mm	
	06A-4083-	Black, Black Nickel, Brass, Polished Chrome, Satin Chrome, White	96mm	104mm	
	P219	Brushed Nickel	96mm		\$1.76
Plastic					
	06A-70128	White	96mm	104mm	
	06A-70528	White	76mm	86mm	

Cabinet Pulls - Gallery Rail

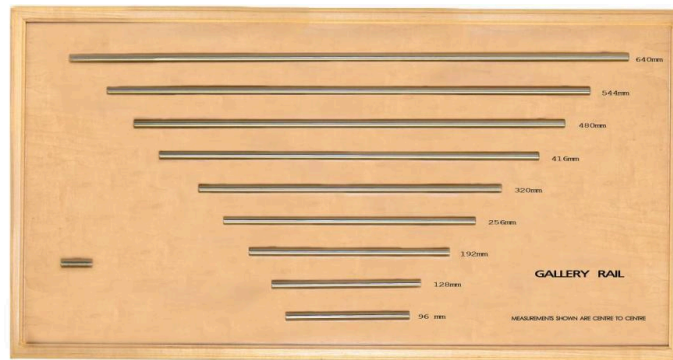
	Item #	Finish:	c.c.	Overall	Price	Pack.
	06A-33040	Brushed Nickel		40mm	\$1.60	20
	06A-33076	Brushed Nickel	76mm	136mm	\$1.84	20
	06A-33096	Brushed Nickel	96mm	156mm	\$2.00	20
	06A-33128	Brushed Nickel	128mm	188mm	\$2.18	20
	06A-33160	Brushed Nickel	160mm	220mm	\$2.32	20
	06A-33192	Brushed Nickel	192mm	252mm	\$3.46	20
	06A-33256	Brushed Nickel	256mm	305mm	\$4.44	20
	06A-33320	Brushed Nickel	320mm	380mm	\$5.68	10
	06A-33416	Brushed Nickel	416mm	475mm	\$12.84	10
	06A-33480	Brushed Nickel	480mm	560mm	\$14.58	10
	06A-33544	Brushed Nickel	544mm	603mm	\$16.80	10
	06A-33640	Brushed Nickel	640mm	700mm	\$19.76	10
	06A-33720	Brushed Nickel	720mm	780mm	\$24.20	
	06A-33870	Brushed Nickel	870mm	980mm	\$29.64	
	PT - 96	Black	96mm	156mm	\$2.44	
	PT - 128	Black	128mm	188mm	\$2.62	
	PT - 160	Black	160mm	220mm	\$2.78	



Cabinet Pulls - Aluminum

	Item #	Finishes:	c.c.	Overall	Price	Pack.
	06A-43040	Silver Anod.	25 mm	40mm		25
	06A-90822	Aluminum	3-7/8"			12









Designer Hardware Series (Pulls)

	Item #	Finish:	c.c.	Overall	Price
	06A-44000	Brushed Nickel	96 mm	6-3/4"	\$5.00
	PHF070	Black, Bright Anodized, Champagne Gold	25mm	38mm	\$1.30
			64mm	100mm	\$2.10
			160mm	192mm	\$3.16
	P10071	Black, Brushed Nickel	128mm	138mm	\$3.60
			160mm	170mm	\$4.00
	P10072	Black, Brushed Nickel	128mm	154mm	\$2.94
			160mm	190mm	\$3.76
	P1018	Brushed Nickel, Matte Black Nickel, Polished Chrome	128mm	180mm	\$6.06
			160mm	223mm	\$7.30
			224mm	276mm	\$11.40
	P10745	Brushed Nickel	128mm	144mm	\$2.90
	P14	Brushed Nickel	128mm	167mm	\$3.90
			160mm	200mm	\$4.30
			192mm	231mm	\$6.96
			256mm	295mm	\$8.48
			320mm	358mm	\$10.92
	P26326	Brushed Nickel, Matte Black Nickel, Polished Chrome	96mm	112mm	\$6.68
			128mm	144mm	\$7.32
			160mm	175mm	\$8.04
			320mm	336mm	\$13.44
*prices for polished chrome vary slightly					
	P26852	Brushed Nickel Matte Black, Matte Black Nickel	128mm	145mm	\$9.48
			160mm	177mm	\$10.96
			224mm	242mm	\$14.38
	P26980A	Champagne Gold, Polished Chrome	128mm		\$6.40
			160mm	167mm	\$6.40
	P2C 128	Brushed Nickel	128mm	176mm	\$3.12
	P2T-CP	Black Stripe/Chrome, Silver Stripe/Chrome, White Stripe/Chrome	128mm	145mm	\$9.50
			160mm	175mm	\$11.04
			320mm	336mm	\$22.06











Designer Hardware Series (Pulls)

	Item #	Finishes:	c.c.	Overall	Price
	P2T-SC	Satin Chrome/Pol. Brass	96mm	140mm	\$3.46
	P3001	Satin Chrome	96mm	125mm	\$3.08
			128mm	157mm	\$3.58
(Temporarily Unavailable) 	P3231	Cystal-style/Chrome Base	96mm	136mm	\$14.70
			128mm	172mm	\$19.95
	P3232	Cystal-style/Chrome Base	96mm	140mm	\$8.80
	P3263	Cystal-style/Chrome Base	96mm	118mm	\$6.06
	P5014	Brushed Nickel	128mm	137mm	\$5.36
			160mm	169mm	\$6.12
			256mm	265mm	\$11.32
			320mm	330mm	\$13.20
	P7011	Black, Brushed Nickel, Champagne Gold, Matte Black Nickel, Polished Chrome	32mm	40mm	\$2.96
			96mm	106mm	\$3.90
			128mm	137mm	\$4.62
			160mm	168mm	\$5.80
			256mm	265mm	\$9.96
			320mm	330mm	\$11.44
		*price for Black, Champgane Gold and Matte Black Nickel are slightly higher			
	P7012	Brushed Nickel	128mm	158mm	\$10.50
			160mm	190mm	\$12.10
			256mm	287mm	\$15.44
			320mm	350mm	\$17.78
	P7026	Brushed Nickel	96mm	126mm	\$8.14
			128mm	159mm	\$10.00
			160mm	190mm	\$11.48
			256mm	287mm	\$14.58
			320mm	350mm	\$16.54
	P7074	Brushed Antique Nickel, Oil Rubbed Bronze	128mm	141mm	\$5.74
			160mm	173mm	\$7.66

Designer Hardware Series (Pulls)

	Item #	Finishes:	c.c.	Overall	Price
	P7076	Brushed Nickel	128mm	164mm	\$7.12
			160mm	191mm	\$9.86
			256mm	290mm	\$12.95
			320mm	352mm	\$15.16
	P7090	Black, Brushed Nickel, Polished Chrome	128mm	168mm	\$3.46
			160mm	202mm	\$4.84
			256mm	300mm	\$7.98
			320mm	362mm	\$9.88
*price varies slightly for Polished Chrome finish					
	P7096	Brushed Nickel	128mm	166mm	\$9.64
			192mm	232mm	\$11.86
			256mm	295mm	\$14.58
			320mm	360mm	\$17.16
	P7105	Brushed Nickel, Champagne Gold, Polished Chrome	128mm	141mm	\$6.40
			160mm	175mm	\$7.98
			256mm	270mm	\$12.34
			320mm	335mm	\$14.70
	P7151	Natural Iron, Polished Chrome	96mm	146mm	\$7.16
			128mm	178mm	\$7.90
			160mm	212mm	\$9.02
			256mm	308mm	\$13.82
			320mm	370mm	\$16.54
	P7214	Clear bar with Chrome ends	128mm	140mm	
			160mm	172mm	
			256mm	269mm	
			320mm	336mm	
	P762	Black Oil Rubbed Bronze	76mm	140mm	\$3.08
			76mm	140mm	\$3.22
	P765	Brushed Nickel, Natural Natural Iron	96mm	125mm	\$2.60















Designer Hardware Series (Pulls)

	Item #	Finish	c.c.	Overall	Price
	P766	Anthracite, Antique Copper, Brushed Nickel, Dark Pewter, Natural Iron	96mm	109mm	\$2.72
	P768	Anthracite, Dark Pewter	96mm	115mm	\$3.96
	P769	Anthracite, Brushed Nickel, Brushed Nickel, Dark Pewter Natural Iron	96mm	110mm	\$2.72
	P770	Anthracite, Dark Pewter	76mm	125mm	\$3.96
	P773	Anthracite, Antique Copper Brushed Nickel, Dark Pewter Natural Iron	96mm	128mm	\$2.96
	P775	Brushed Nickel	96mm	131mm	\$4.56
	P779	Brushed Nickel	128mm 160mm 256mm 320mm	135mm 170mm 265mm 330mm	\$5.44 \$6.66 \$10.98 \$13.58
	P80391	Brushed Nickel	128mm	138mm	\$3.16
	P80519	Brushed Antique Nickel	128mm 160mm	140mm 170mm	\$7.52 \$9.60
	P80710	Brushed Nickel	160mm	176mm	\$6.40

Designer Hardware Series (Pulls)

	Item #	Finish	c.c.	Overall	Price
	P81019	Brushed Antique Nickel, Brushed Nickel	128mm	165mm	\$8.30
			160mm	198mm	\$9.86
			192mm	229mm	\$12.70
			305mm	354mm	\$37.60
		*price varies slightly for the Brushed Nickel finish			
	P81419	Brushed Nickel	96mm	119mm	\$4.42
			128mm	147mm	\$5.18
			160mm	177mm	\$6.48
			192mm	210mm	\$8.30
			256mm	273mm	\$11.02
	P81572	Brushed Nickel Polished Chrome	128mm	150mm	\$3.80
			160mm	188mm	\$5.40
			192mm	220mm	\$7.60
			256mm	290mm	\$11.00
			320mm	357mm	\$13.00
	P81670	Brushed Nickel	76mm	134mm	\$3.14
			96mm	156mm	\$3.56
			128mm	196mm	\$4.30
			192mm	274mm	\$6.54
	P82826	Brushed Nickel, Oil Rubbed Bronze	96mm	156mm	\$4.88
			128mm	197mm	\$6.38
	P838	Antique Brass, Antique Copper Black, Black Nickel, Brushed Antique Nickel, Brushed Nickel, Dark Pewter, Oil Rubbed Bronze, Pewter, Polished Chrome, Satin Chrome	64mm	103mm	\$2.22
	P83848	Brushed Nickel	128mm	169mm	\$4.74
	P83849	Brushed Nickel	160mm	200mm	\$5.66
	P86374	Brushed Antique Nickel, Brushed Nickel Oil Rubbed Bronze	128mm	148mm	\$4.92
			160mm	182mm	\$7.02
			192mm	212mm	\$9.08
	P9007	Oil Rubbed Bronze	128mm	145mm	\$3.96
			303mm	332mm	\$37.04

Cabinet Knobs

Item #	Price	Item #	Price
 06B-20000 Ceramic, White		 06B-50- - - Wood - Birch, Maple, Oak, Pine	
 06B-71028 Plastic, White		 K003S K003L Crystal Style	\$4.64 \$6.18
 K2058 Brushed Nickel	\$2.36	 K2105 Brushed Nickel	\$4.70
 K252 Brushed Nickel	\$2.36	 K3168 Black, Champagne Gold, Polished Chrome	
 K3231 Crystal Style	\$6.08	 K3259S K3259L Crystal Style	\$8.56 \$11.22
 K512B Crystal Style	\$7.50	 K7074 Brushed Antique Nickel, Oil Rubbed Bronze	\$5.10
 K779 Brushed Nickel	\$3.96	 K80519 Br. Antique Nickel	\$3.40
 K81019S K81019L Brushed Antique Nickel, Oil Rubbed Bronze	\$3.82 \$4.34	 K81023 Brushed Nickel	\$3.70
 K81431 Brushed Nickel	\$3.24	 K84040 Brushed Nickel	\$5.60

Cabinet Knobs

Item #	Price	Item #	Price
 K9001 – 25 K9001 – 35 Brushed Nickel, Polished Chrome	2.14 \$3.06	 K9007 Oil Rubbed Bronze	\$3.34
 K955 Brushed Nickel	\$3.70	 K969 Anthracite, Antique Copper, Br. Ant. Copper w/pol. Brass Edge Brushed Nickel, Dark Pewter, Natural Iron	
 K971 Anthracite, Dk. Pewter	\$2.70	 K972 Anthracite, Dk. Pewter	\$2.80
 K973 Anthracite, Antique Copper, Brushed Nickel, Dark Pewter, Natural Iron	\$2.36	 K974S K974L S: Brushed Nickel L: Brushed Nickel, Pol. Chrome	\$3.70 \$3.96
 K976 Anthracite, Antique Copper, Brushed Nickel, Dark Pewter, Natural Iron	\$2.54	 K992 Brushed Nickel	\$3.96
 K998 Brushed Nickel	\$5.44	 K999S K999L Polished Chrome	\$2.80 \$4.88
 KH32 Anthracite, Black, Black Nickel, Oil Rubbed Bronze, Pewter, Polished Brass, Polished Chrome	\$1.60	 KSQ2913 Brushed Nickel	\$1.90

Section 7 • Hinges

Table of Contents

Salice Hinges	Page 7.1
Salice Baseplates	Page 7.3
Glass Door Hinges	Page 7.5
Traditional Hinges	Page 7.6
Piano Hinges	Page 7.7
Miscellaneous Hinges	Page 7.8
Institutional Hinges - RPC	Page 7.10
Door Hinges, Residential	Page 7.12
Commercial Hinges	Page 7.13
Special Application	Page 7.14

- Silencia – with the concealed soft close mechanism, allowing a 3-5 second closure from 30° with no hesitation
For a demonstration video please go to:
<https://www.youtube.com/watch?v=c5HDY-5XqYU>
- PUSH – a push-to-open hinge eliminating the need for door pulls and now the new Titanium finish to complement the darker wood tones, while providing ultimate functionality and increased corrosive strength

Visit Salice.com > Products > Hinges
to see all the hinge products available

Recommended Number of Hinges per Door

The number of hinges required depends on the size, weight and quality of the door. The distance between the hinges should be spaced as wide as possible. Use the diagram below to determine number of hinges needed.

For doors to 24" wide, weighing up to
 20lbs. - 2 hinges
 20 - 40 lbs.- 3 hinges
 40 - 60 lbs.- 4 hinges

These recommendations are for doors without accessory attachments only.

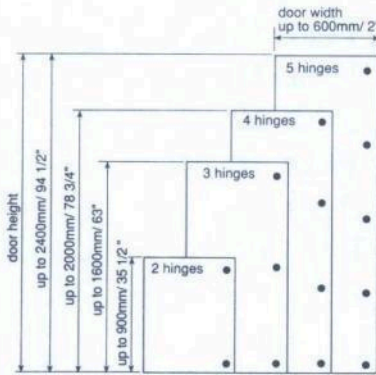

Exceptions to number of hinge recommendations

- In abusive environments such as schools and hospitals, additional hinges should be added if doors are near the border line of size or weight chart.
- In abusive environments, it is best to keep doors to a maximum of 508mm (20") in width. This prevents undue leverage against the doors.
- In abusive environments, use an institutional type of hinge such as the GRASS 950 Hinge series.



07A-90010
DOLHSNG



07A-31010
Single pivot 270°
institutional hinge
CMR3A99

Salice Series 200 HingesFull Overlay

BML #	Closure	Salice #	Opening	Finish
07A-10000	S/C	C2P6A99	110°	Nick/Pl
07A-10010	S/C	C2R6A99	110°	Nick/Pl
07A-10012	F/S	C2R4A99	110°	Nick/Pl
07A-22000	S/C	C2PFA99	165°	Nick/Pl
07A-22010	S/C	C2RFA99	165°	Nick/Pl
07A-27000	PUSH	C2PPA99	110°	Nick/PL
07A-40010	S/C	C2RBA66	110°	Titanium

Half Overlay

BML #	Closure	Salice #	Opening	Finish
07A-10110	S/C	C2PBG99	94°	Nick/Pl
07A-10102	F/S	C2P4G99	110°	Nick/Pl
07A-22100	S/C	C2PFG99	165°	Nick/Pl
07A-22102	F/S	C2PEG99	165°	Nick/Pl
07A-22110	S/C	C2RFG99	165°	Nick/Pl

Inset

BML #	Closure	Salice #	Opening	Finish
07A-20310	S/C	C2RBP99	94°	Nick/Pl
07A-22310	S/C	C2RFP99	165°	Nick/Pl

Salice Silentia Soft Close Hinges

BML #	Overlay	Salice #	Opening	Finish
07A-11010	Full	C1R6AE9	105°	Nick/Pl
07A-11110	Half	C1R6GE9	105°	Nick/Pl
07A-11310	Inset	C1R6PE9	105°	Nick/Pl
07A-11710	Full	C2RKAD9	155°	Nick/Pl
07A-41010	Full	C1R6AE6	105°	Titanium
07A-41110	Half	C1R6DE6	105°	Titanium
07A-41210	Inset	C1R6PE6	105°	Titanium
07A-41710	Full	C2RKAD6	155°	Titanium

Salice Silentia Special Application Soft Close Hinges

BML #	Overlay	Salice #	Opening	Finish
07A-11410	Partial	C2RBM99AC	45°	Nick/Pl
07A-11510	Inset	C2RBN99AC	Blind Corner	Nick/Pl
07A-41410	Partial	C2RBW99	45°	Titanium

Salice Series 200 Hinges/Self Close

Salice Special Application Hinges

BML #	Overlay	Salice #	Opening	Application
07A-20410	Partial	C2RBM99AC	94°	45°
07A-20510	Inset	C2RBN99AC	94°	Blind Corner
07A-20530	Inset	C2PBN99	94°	B/C Short Arm
07A-18300	N/A	B2SGB99B6	N/A	Plate / Short Arm
07A-20600	Partial	C2PBE99	94°	30°
07A-23010	Partial	C2RBW99	120°	Neg. 30°
07A-23100	Partial	C2PBH99	120°	Neg. 45°
07A-24110	N/A	C2RYA99	70°	Lazy Susan

For Doors Up To 1-1/8" Thick

BML #	Overlay	Salice #	Opening	Cup Diameter
07A-25310	Full	C2RKA99	155°	35mm



For Doors Up To 1-1/4" Thick

BML #	Overlay	Salice #	Opening	Cup Diameter
07A-10100	Half	C2PBG99	94°	35mm
07A-20310	Inset	C2RBP99	94°	35mm
07A-25000	Full	C2PBA99	94°	35mm

Salice B-Series Hinges

BML #	Overlay	Salice #	Opening	Finish
07A-23100	Partial	C2PBH99	120°	NEG 45°
07A-24110	N/A	C2RYA99	70°	Lazy Susan

Salice Face Frame Hinges/Soft Close

BML #	Overlay	Salice #	Opening	Finish
07A-63299	1"	CUR32D9R	106°	Nickel
07A-63499	3/4"	CUR34D9R	106°	Nickel
07A-63599	5/8"	CUR35D9R	106°	Nickel
07A-63799	1/2"	CUR37D9R	106°	Nickel
07A-63899	1-1/4"	CUR3AD9R	106°	Nickel

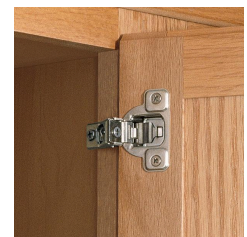

Salice Slide-On Mounting Plates

BML #	Screw	Salice #	Thickness	Adjustability		
				Height	Lt./Rt.	In/Out
07A-15209	Wood	B2V3H69	9mm	Manual	Manual	Manual
07A-15300	Euro	B2VGH09	0mm	Manual	Manual	Manual
07A-15303	Euro	B2VGH39	3mm	Manual	Manual	Manual
07A-15306	Euro	B2VGH69	6mm	Manual	Manual	Manual
07A-15398	Euro	B2VGHS9	Neg. 2mm	Manual	Manual	Manual
07A-16203	Wood	B2R3E39	3mm	Cam	Cam	Cam



Salice Clip-On Mounting Plates - Chrome

BML #	Screw	Salice #	Thickness	Adjustability		
				Height	Lt./Rt.	In/Out
07A-17100	Wood	BAV3L09F	0mm	Manual	Cam	Cam
07A-17103	Wood	BAV3L39F	3mm	Manual	Cam	Cam
07A-17206	Wood	BAV3E69F	6mm	Manual	Cam	Cam
07A-17209	Wood	BAV3E99F	9mm	Manual	Cam	Cam
07A-17303	Euro	BAVGL39F	3mm	Manual	Cam	Cam
07A-17900	Wood	BAR3R09	0mm	Cam	Cam	Cam
07A-17903	Wood	BAR3R39	3mm	Cam	Cam	Cam
07A-17906	Wood	BAR3R69	6mm	Cam	Cam	Cam
07A-17909	Wood	BAR3R99	9mm	Cam	Cam	Cam
07A-17912	Wood	BAR3RC9	12mm	Cam	Cam	Cam
07A-17918	Wood	BAR3RV9	18mm	Cam	Cam	Cam
07A-17950	Euro	BARGR09	0mm	Cam	Cam	Cam
07A-17953	Euro	BARGR39	3mm	Cam	Cam	Cam
07A-17959	Euro	BARGR69	9mm	Cam	Cam	Cam



Salice Clip-On Mounting Plates - Titanium

BML #	Screw	Salice #	Thickness	Adjustability		
				Height	Lt./Rt.	In/Out
07A-47902	Wood	BAR3R26	2mm	Cam	Cam	Cam
07A-47904	Wood	BAR3R46	4mm	Cam	Cam	Cam
07A-47952	Euro	BARGR26	2mm	Cam	Cam	Cam
07A-47954	Euro	BARGR46	4mm	Cam	Cam	Cam

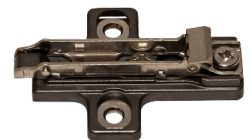

Salice Variable Angle/Specialty Mounting Plates

BML #	Screw	Salice #	Thickness	Degree	Function	
07A-18002	Euro	B2VGBW9		15	Var. Angle	
07A-18010	Euro	B2V3BW9R		7.5 +/-	Var. Angle	
07A-18020	Wood	B2V3BW9S		10+ - 30+	Var. Angle	
07A-18101	Wood	B2U3B19	1mm		Face Frame	Slide On
07A-18201	Wood	BAU3L19	1mm		Face Frame	Clip On
07A-18204	Wood	BAU3L49	4mm		Face Frame	Clip On
07A-18400	Wood	BAL3R59	Inset		Face Frame	Clip On

Salice Accessories

BML #	Description	Salice #
07A-28025	Magnetic Release And Strike	DPMSNB DP28SN9
07A-28039	Magnetic Strike Plate Adjustable	DP39XXG
07A-28830	Push Double Adapter for MAG Latch	DP83XXBR
07A-28840	Push Single Adaptor for MAG Latch	DP84SNBR
07A-70000	Reduction Clip 86 Degree Opening	S2A637XF
07A-90010	Smove For Series 200 Hinged Doors	D0LHSNG
07A-99100	Hinge Arm Cover Steel Titanium	S2BX83H6
07A-99101	Hinge Flange Cover Steel Titanium	S2XX85H6

Glass Door Pivot Hinges & Strikes

Item #	Finish	Description	Sold By:	Pack.
07C-20010	Florentine	Glass strike - brass	Each	25
07C-20011	Chrome	Glass strike - chrome	Each	25
07C-20012	Black	Glass strike - black	Each	25

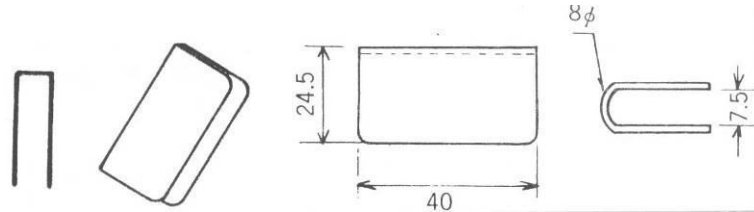

07C-20020	Florentine	Glass strike with handle - brass	Each	25
07C-20021	Chrome	Glass strike with handle - chrome	Each	25
07C-20022	Black	Glass strike with handle - black	Each	25

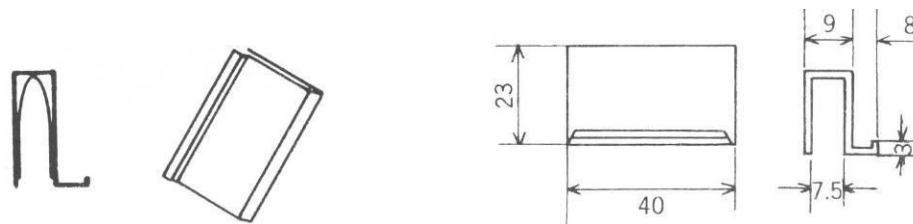

07C-10000	Florentine	Glass pivot hinge, 1" x 2" brass	Pair	25
07C-10001	Chrome	Glass pivot hinge, 1" x 2" chrome	Pair	25
07C-10003	Black	Glass pivot hinge, 1" x 2" black	Pair	25

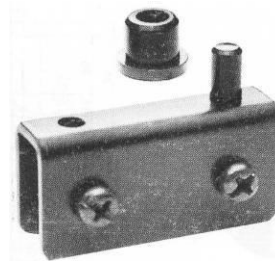

07C-10010	Florentine	Glass arm hinge - brass	Pair	25
07C-10013	Black	Glass arm hinge - black	Pair	25
07C-10103	Black	Wood door pivot hinge - black	Pair	25

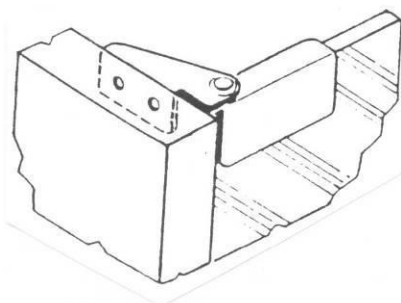

Glass arm hinge

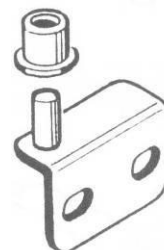

Wood door pivot hinge

Traditional Hinges

Item #	Finish	Description	Pack
07C-20007	Nickel	Butt hinge 2-1/2"x1-5/8"(open width)	12
07C-20008	Brass Plated	Butt hinge 2-1/2"x1-5/8"(open width)	12
07C-20300	Florentine	Double leaf friction hinge - Brass	50

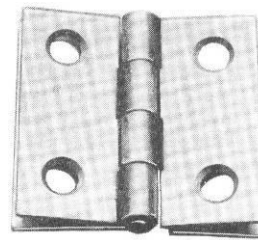
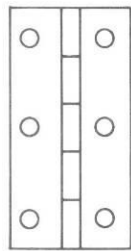

Item #	Finish	Description	Sold By:
07C-20101	Bronze	Non-mortise butt hinge, 2-1/2" x 3/4" - Bronze	Each
07C-20205	Span Brass	Non-mortise butt hinge, 2" x 11/16" finial ends	Each
07C-20206	Satin Nickel	Non-mortise butt hinge, 2" x 11/16" finial ends	Pair

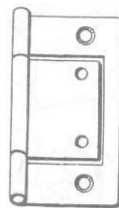

Item #	Finish	Description	Sold By:
07C-30000	Florentine	Flush hinge	Pair
07C-30001	Chrome	Flush hinge	Pair
07C-30005	Span Brass	Flush hinge	Pair
07C-30015	Span Brass	Inset, 1/4" overlay	Pair
07C-30035	Span Brass	Inset, 3/8" overlay	Each

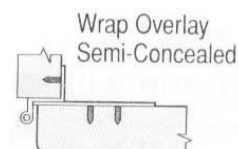
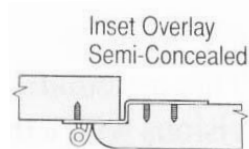
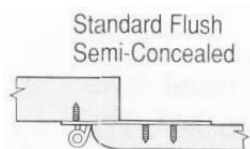
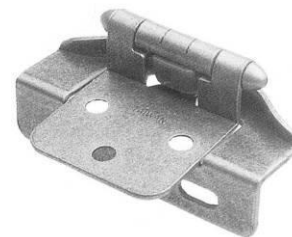
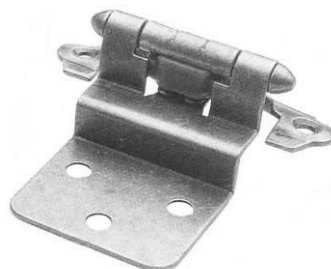

Piano Hinges

Item #	Finish	Description	Sold By:	Pack.
07C-41030	Brass Plated	Piano hinge 1-1/2" x 30"	Each	50
07C-41230	Nickel Plated	Piano hinge 1-1/2" x 30"	Each	50
07C-40072	Brass Plated	Piano hinge 1-1/4" x 72"	Each	50
07C-40272	Nickel Plated	Piano hinge 1-1/4" x 72"	Each	50
07C-41272	Nickel Plated	Piano hinge 1-1/2" x 72"	Each	50
07C-48272	Nickel Plated	Piano hinge 2" x 72" HD	Each	25
07C-49272	Nickel Plated	Piano hinge 1-1/2" x 72" HD	Each	50

- hinges are pierced and countersunk for #5 screws every 2"
- thickness is .030 except HD are .040"
- other sizes and finishes are available (for example ... architectural hinges up to 4-1/2" open width)

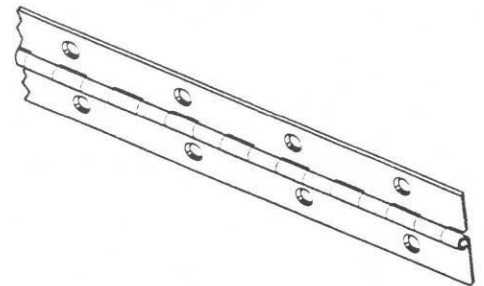

The precut (30") lengths provide a labour-saving, premium quality finished product for lazy susan kitchen corner cabinets.

Miscellaneous Hinges

Item #	Finish	Description	Sold By:	Pack:
07C-21012	Brass	Concealed hinge 12mm x 27mm long	Each	48
07C-21014	Brass	Concealed hinge 14mm x 31mm long	Each	24

- machined solid brass with steel linkage
- drill mm size holes to exact depth
- 16, 18 and 24mm also available

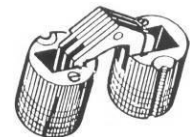

Item #	Finish	Description	Sold By:
07C-21100	Black	Concealed hinge / steel linkage	Each

- nylon body
- screwless -application
- incorporated set-screw expand
- wedge locks to secure in wood
- make mortise with 12mm bit

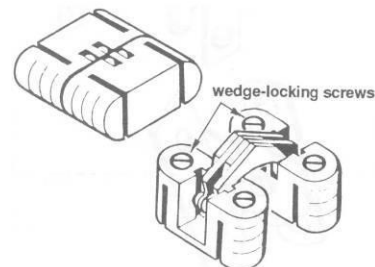

Miscellaneous Hinges

Item #	Finish	Description	Sold By:
07C-21105	Nickel	Surface mount concealed hinge 150°	Each

- 150° door opening without drilling holes and without using mounting plates
- one hinge fits all door conditions
- self-closing
- heavy-duty, case hardened steel

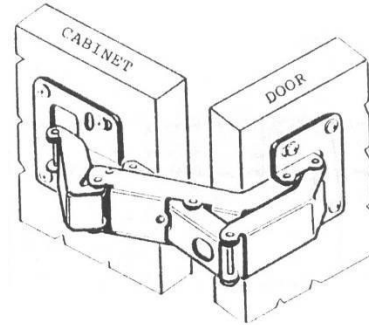

Item #	Finish	Description	Sold By:
07C-60010	Brown	Drop flap hinge	Each

- flap opens flush with inside shelf
- fits flush in door and shelf surfaces
- completely concealed from exterior

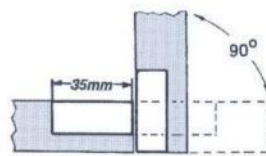

Item #	Finish	Description	Sold By:
07C-20351	Brass plated	Double action hinge for 1" to 1-1/8" panels	Each
07C-20352	Brass plated	Double action hinge for 1-1/8" to 1-1/4" panels	Each

- steel folding screen hinge
- opens in both directions

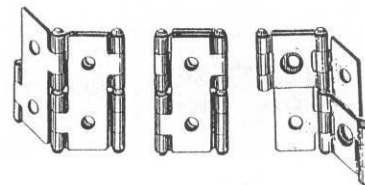

Miscellaneous Hinges

Item #	Finish	Description	Sold By:
07C-22000	Satin Brass	Butler tray hinge - square	Each
07C-22100	Satin Brass	Butler tray hinge - round	Each

- Butler tray hinge locks open in flat position and holds vertical at 90° (3" long x 1-1/2" wide)

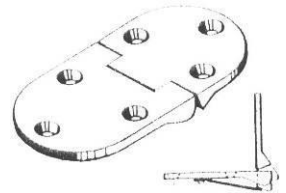

Item #	Finish	Description	Sold By:
07C-22200	Brass	Flap Hinge H-205	Each

- flap hinge and sewing machine hinge
- 1-1/4" x 3/8"

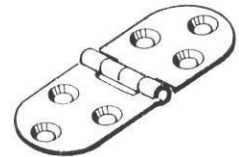

Item #	Finish	Description	Sold By:
07C-60123	Steel, black	Internal self-balanced support	Each

- anti-slam lift-up support for toy chests, piano benches, etc. (S-57554L)

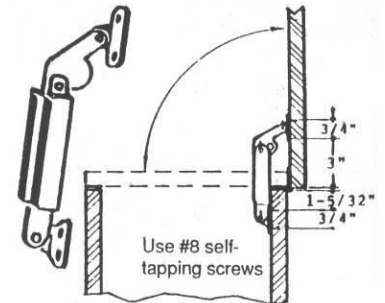

Institutional Hinges - RPC

European Hinges weren't made for American Kids!!!

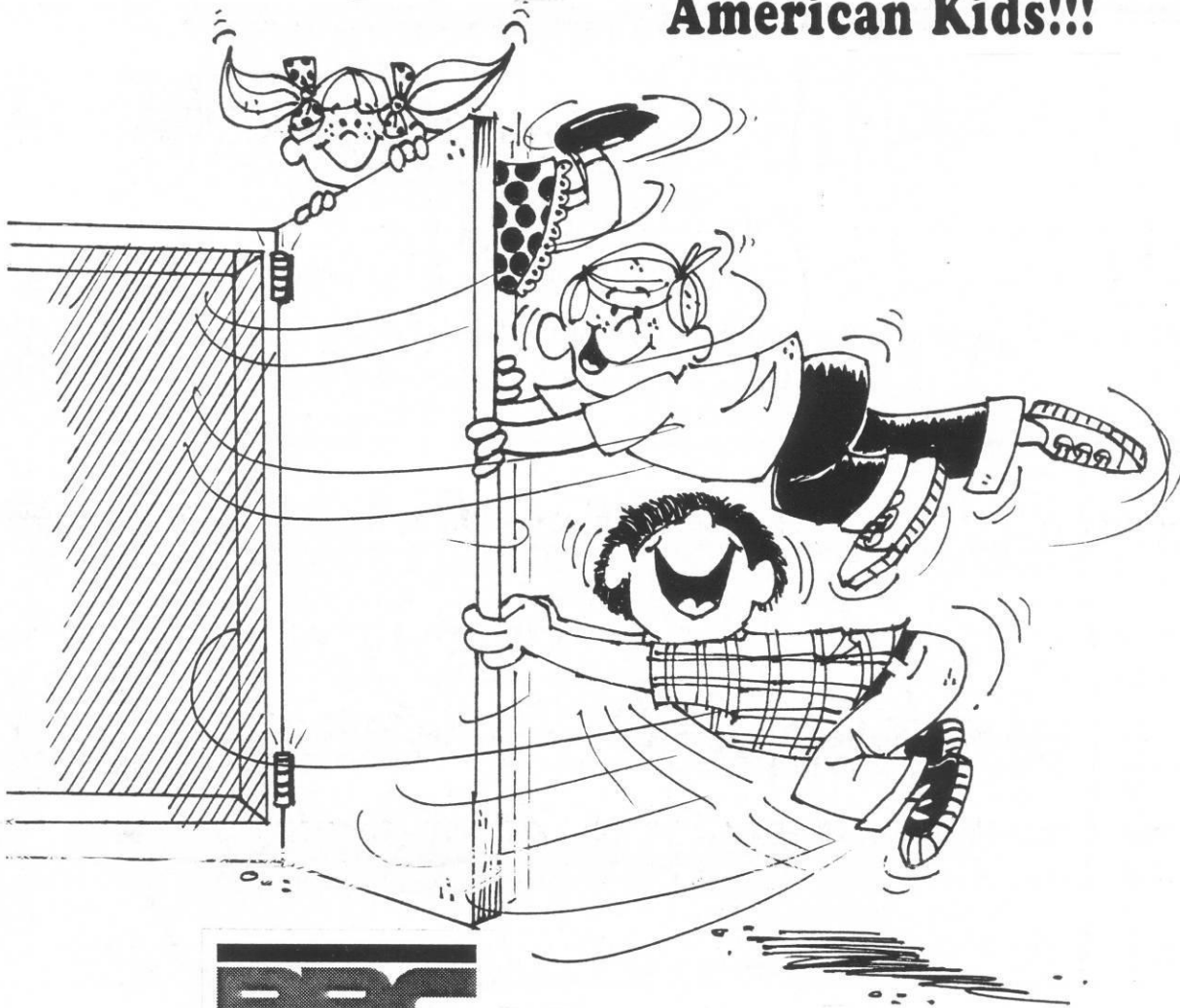

Hinges were!

Item #	Finish	Description	Side Panel A	Door Thick B
07C-50001	Black	RPC374 Overlay	3/4"	3/4"
07C-50002	Stainless	RPC376 Overlay	3/4"	13/16"
07C-50004	P28	RPC374 Overlay	3/4"	3/4"
07C-50009	26D	RPC860 Flush Hinge	N/A	3/4"
07C-50010	26D	RPC7036 Overlay	3/4"	up to 1-3/8"
07C-50349	P27	RPC349 Lipped Hinge		

Institutional Hinges - RPC

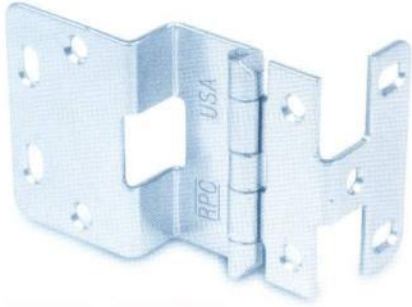

374 / 376 Overlay Hinge

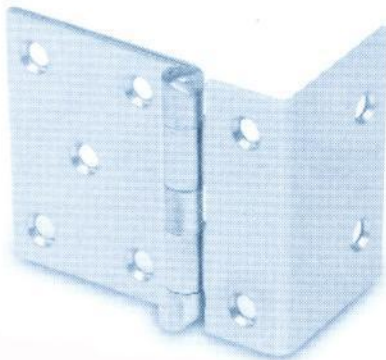
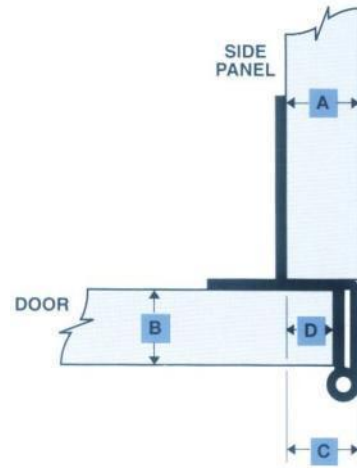

860 Flush Hinge

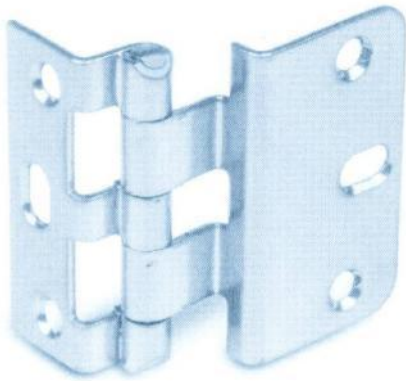
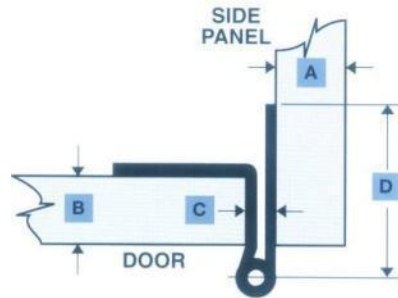

349 Lipped Hinge

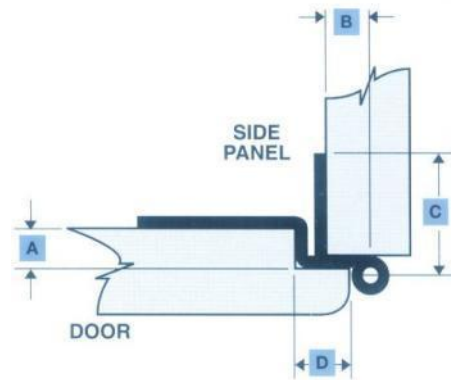

Interior Door Hinges (Residential)

Size	Radius	Finish	Pack.
*3-1/2" x 3-1/2"	1/4	See Below	50pr.
*3-1/2" x 3-1/2"	5/8	See Below	50pr.
*3-1/2" x 3-11/16"	5/8 - square	C26D, C2G, C4	50pr.

Exterior Door Hinges (Residential)

Size	Radius	Finish	Pack.
4" x 4"	1/4	See Below	50pr.
4" x 4"	5/8	See Below	50pr.
4" x 4"	5/8 - square	C26D, C2G, C4, CP	50pr.
4" x 4"	1/4	C26D, C4	50 pr.
4" x 4"	5/8	C26D, C4	50 pr.

Finishes:

10B - Oil Rubbed Bronze

15A - Brushed Nickel

17A - Antique Nickel

26 - Polished Chrome

26D - Brushed Chrome

C2G - Brushed Zinc

C4 - Satin Brass

L1 - Matt Black

*C3 - Polished Brass (Not available in NRP)

Primed (CP) also available in 4x4, 1/4R & 5/8R

* Not available in NRP



Commercial Ball Bearing Hinges

Size	Radius	Finish	Pack.
*3-1/2" x 3-1/2"	square	10B, 17A, 26, 26D	25 pr.
*3-1/2" x 3-1/2"	1/4"	See below	25 pr.
*3-1/2" x 3-1/2"	5/8"	See below	25 pr.
4" x 4"	1/4"	See Below	25 pr.
4" x 4"	5/8"	See Below	25 pr.
4-1/2" x 4"	square	10B, 15A, 26, 26D, 32D, C4	16 sets
4-1/2" x 4"	5/8"	C26D	16 sets

Finishes:

- 10B: Oil Rubbed Bronze
- 15A: Brushed Nickel
- 17A: Antique Nickel
- 26: Polished Chrome
- 26D: Brushed Chrome
- L1: Matt Black
- C3: Polished Brass (Not available in NRP)

* : Not available in NRP

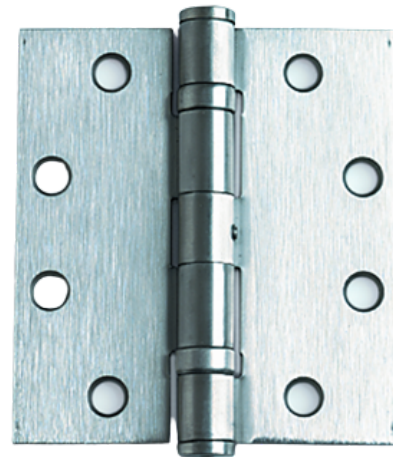

Wind - Lift System

Combining the highest levels of performance with smooth and perfectly controlled movement. This compact lift system has strong functional appeal and takes up a minimum of valuable storage space. Wind is versatile, elegant, unobtrusive and suitable for a vast range of furniture applications: office furniture, kitchens, bathrooms, living- and bedroom furniture.

Salice Item #	Description	Sold By:
FRAKFEP_SN9	Wind - Lift System	Each

- available in numerous attractive finishes
- Soft close mechanism for decelerated closing.
- 85° - 94° opening
- Door height from 220 mm to 600mm
- Door weight from 1.5kg to 24kg
- Adjustable spring strength
- With an optional carrier, Wind can be used in corner cabinets and for doors of large weight and dimensions.



Visit: YouTube at this link to see it in action:
https://youtu.be/xWL0U1_2t5g?t=7

Exedra - Pocket Door System

Pocket door system with assisted sliding action enhanced by linear damping to gently control the movement of the door.

Salice Item #	Description	Sold By:
Exedra	Exedra - Pocket Door System	Each

- Max. weight: 30 kg (66 lbs) with 5 hinges
- Thickness from 19 mm (3/4") to 30 mm (1-3/16")
- Width: 400 mm (15-3/4") to 900 mm (35-7/16")
- Height: 1333 mm (51-1/16") to 2530 mm (99-5/8")
- can be equipped with a Smove damper, conferring a perfect decelerating effect
- Vertical, horizontal and front door adjustment
- Easy to install
- Soft closing movement while sliding in and out
- enables the optimisation of space
- Available in standard version, partially assembled and customized

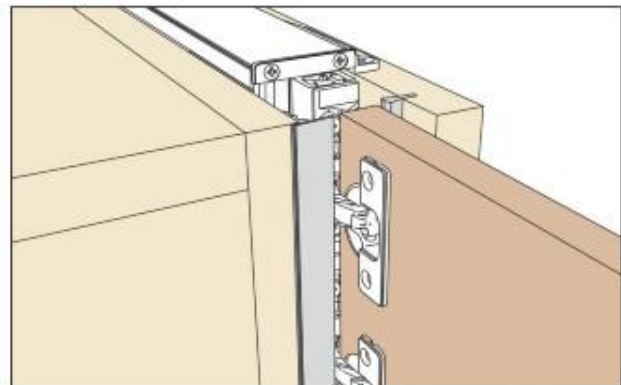

Visit: YouTube at this link to see it in action:
<https://youtu.be/dgmgRzSINg0>

Coplanar System

Coplanar system for kitchen cabinets and wall cabinets with doors weighing up to 20 kg (44 lbs). Available in different options: **Reverso** enabling the doors to be opened in the opposite direction, **Step** allowing the doors to be opened when separated by a central compartment and **One** for the opening of a single door. The **Power** version is motorised.

Salice Item #	Description	Sold By:
Slider S20	Slider S20 - Pocket Door System	Each

- Max. weight per door 20 kg (44 lbs)
- Width from 600 (23-5/8") to 1500 (59") mm
- Max. height 1200 mm (47-7/32")
- Thickness from 19 (3/4") to 45 mm (1-3/4") with handle
- Push system available
- Available in the Standard, One, Step, Reverso and Power versions
- Soft closing movement while opening and closing.
- Material:
 - wood or derived material
 - glass with metal frame.
- Vertical, horizontal and front door adjustment
- can be provided with a customisable front cover
- Available in single-door and/or custom widths
- Available only upon special order request as a custom order
- Sliding is intuitive, smooth and silent
- ideal for units used in the kitchen and bathroom or for furniture intended for the living room, bedroom and offices.
- Door movement and cushioned opening and closing are intuitive and smooth

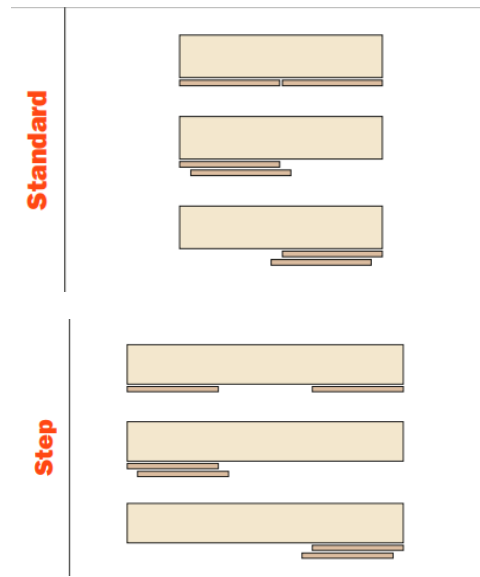
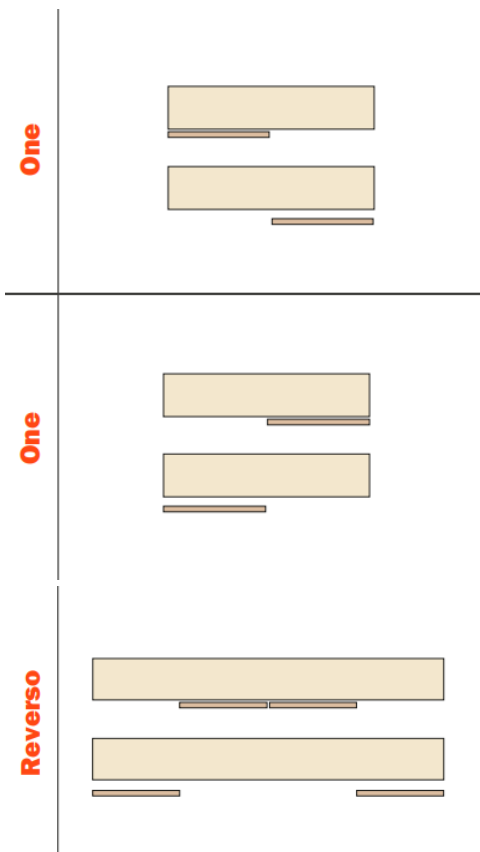

Visit: YouTube at this link to see it in action:
<https://youtu.be/XGEAP-6xZPc>

Air - Concealed Hinge

Despite its compactness and small size, Air delivers full functionality to furniture manufacturers. It is inserted into the top and bottom of the cabinet and the door and is practically invisible. Its small size means that the applications for Air are numerous: kitchens, bathrooms, living and bedroom furniture or display cabinets

Salice Item #	Description	Finish	Sold By:
CEL6XE9XXV	Air Hinge, with Soft Close, 105°	Nickel Plated	Set
CEL6XE6XXV	Air Hinge, with Soft Close, 105°	Titanium	Set
CELPX99XXV	Air Hinge, with Push Opening, 105°	Nickel Plated	Set
CELPX66XXV	Air Hinge, with Push Opening, 105°	Titanium	Set

- For min. 18 mm (3/4") thick wood doors and for aluminum-framed doors.
- Max. door weight 20 Kg (44 lbs).
- Max. dimensions of the door : height 2100 mm (84"), width 610 mm (24").
- 16.5 mm deep metal cup.
- L = 2.5 mm
- 105° opening.
- Possible drilling distance on the door (K): from 3 mm (1/8") to 6 mm (1/4") for wood doors.
- Fixed K = 4 mm for aluminum-framed doors (DEL6LP300_).



Section 8 • Drawer Slides & Systems

Table of Contents

Futura Soft Close Undermount	Page 8.1
Futura Push Undermount	Page 8.1
Progressa Soft Close Undermount	Page 8.2
Accessories	Page 8.3
Precision Ball Bearing Slides	Page 8.4
KV Heavy Duty Slides	Page 8.6
KV Stainless Steel Slides	Page 8.6
KV Push to Open Slides	Page 8.6
KV Extra Heavy Duty Slides	Page 8.7
KV Soft Close Slides	Page 8.8
CGS 120 lb Slides, Regular & Soft Close	Page 8.8
KV Pocket Door Slides	Page 8.9
Wooden Drawer Guides	Page 8.9



Visit KV.com for all products available to us.

Futura Undermount Slide - Soft Close

Item #	Description	Pack.
08F-32270	Futura 6555 F/E Soft Close 270mm	6
08F-32300	Futura 6555 F/E Soft Close 300mm	6
08F-32350	Futura 6555 F/E Soft Close 350mm	6
08F-32400	Futura 6555 F/E Soft Close 400mm	6
08F-32450	Futura 6555 F/E Soft Close 450mm	6
08F-32500	Futura 6555 F/E Soft Close 500mm	6
08F-32550	Futura 6555 F/E Soft Close 550mm	6
08F-32600	Futura 6555 F/E Soft Close 600mm	6
08F-30000	R&L Clips for Futura	100
08F-30010	R&L Clips for Futura 3 way ADJ	100

- dynamic load capacity 34kg (75lbs)
- with Smove decelerated closing
- drawer height adjustment (+2.5mm) with 08F-30000 shown in picture below
- drawer width adjustment +1.5mm/-1.5mm and in/out adjustment +2mm/-2mm with 08F-30010
- Finish: bright zinc-plated

Futura Undermount Slide - Push

Item #	Description	Pack.
08F-33270	Futura 65577 F/E 270mm Push to Open	6
08F-33300	Futura 65577 F/E 300mm Push to Open	6
08F-33350	Futura 65577 F/E 350mm Push to Open	6
08F-33400	Futura 65577 F/E 400mm Push to Open	6
08F-33450	Futura 65577 F/E 450mm Push to Open	6
08F-33500	Futura 65577 F/E 500mm Push to Open	6
08F-33550	Futura 65577 F/E 550mm Push to Open	6
08F-33600	Futura 65577 F/E 600mm Push to Open	6
08F-30000	R&L Clips for Futura	100
08F-30010	R&L Clips for Futura 3 way ADJ	100

- dynamic load capacity 34kg (75lbs)
- push opening system
- drawer height adjustment (+2.5mm) with 08F-30000 shown in picture below
- drawer width adjustment +1.5mm/-1.5mm and in/out adjustment +2mm/-2mm with 08F-30010
- finish: bright zinc-plated
- optional synchronization bar

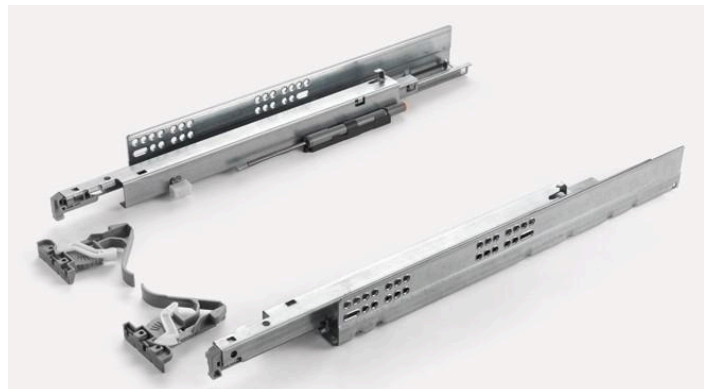

Video showing 3 way adjustment: <https://www.youtube.com/watch?v=6iI1WX4KGOc>

Progressa Undermount Slide 45kg - Soft Close

Item #	Description	Pack.
08F-34350	Progressa Soft Close 350mm (14")	6
08F-34400	Progressa Soft Close 400mm (16")	6
08F-34450	Progressa Soft Close 450mm (18")	6
08F-34500	Progressa Soft Close 500mm (20")	6
08F-34550	Progressa Soft Close 550mm (22")	6
08F-34010	Adjustable Clip for Progressa R+L	100

- dynamic load capacity 45kg (100 lbs)
- Full extension
- with Smove decelerated closing
- drawer height adjustment (+2.5mm)
- drawer side adjustment +1.5mm/-1.5mm and in/out adjustment +3mm/-3mm with 08F-34010
- Compatible with Lineabox drawers
- Finish: bright zinc-plated
- Also available in push-to-open

Progressa+ Undermount Slide 70kg - Soft Close

Item #	Description	Pack.
08F-35350	Progressa+ Soft Close 350mm (14")	6
08F-35400	Progressa+ Soft Close 400mm (16")	6
08F-35450	Progressa+ Soft Close 450mm (18")	6
08F-35500	Progressa+ Soft Close 500mm (20")	6
08F-35550	Progressa+ Soft Close 550mm (22")	6
08F-35600	Progressa+ Soft Close 600mm (24")	4
08F-35650	Progressa+ Soft Close 650mm (26")	4
08F-35700	Progressa+ Soft Close 700mm (28")	4
08F-35750	Progressa+ Soft Close 750mm (30")	4
08F-34010	Adjustable Clip for Progressa+ R+L	100

- dynamic load capacity 70kg (154lbs)
- Full extension
- with Smove decelerated closing
- drawer height adjustment (+2.5mm)
- drawer side adjustment
+1.5mm/-1.5mm and in/out adjustment
+3mm/-3mm with 08F-34010
- Compatible with Lineabox drawers
- Finish: bright zinc-plated
- Also available in push-to-open

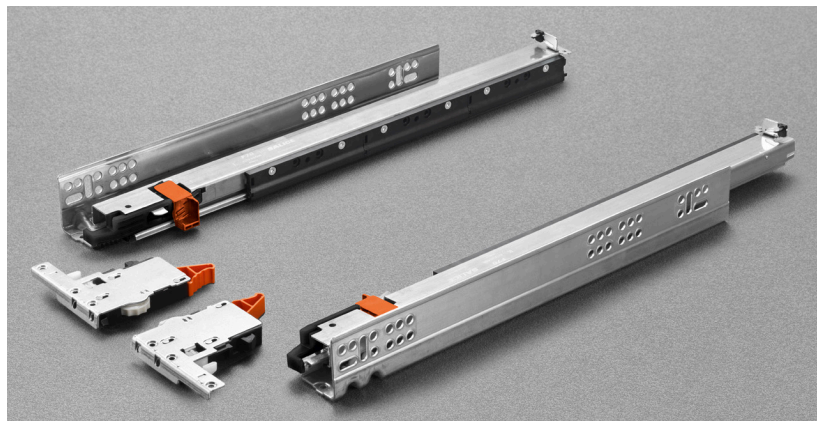

Spacers & Door Protectors

Designed for use in cabinets where pullouts are behind doors, and protrude into cabinet.

Item #	Colour	Description	Pack
08B-90000	White	Plastic Drawer Slide Spacer 25mm	100
08B-90060	White	Pullout Door Protector	100
08B-90061	Tan	Pullout Door Protector	100
08B-90062	Almond	Pullout Door Protector	100
08B-90063	Black	Pullout Door Protector	100

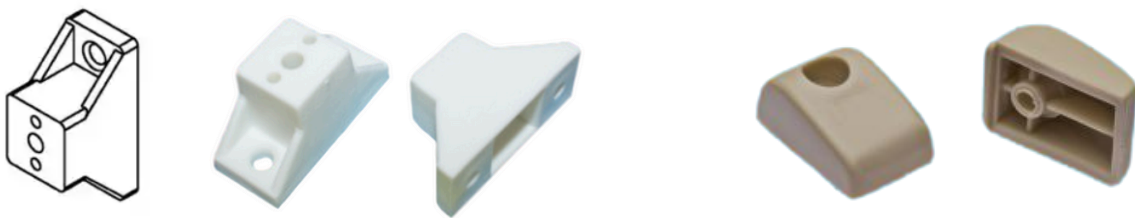

Screw-on Front Bracket for pull-out shelves with 3-way adjustment

Position of mounting holes

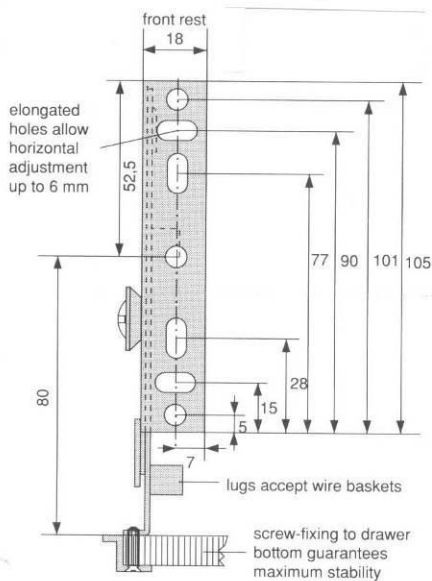

Total adjustment:

- 1. Vertical adjustment with eccentric screw with elongated holes total: 6 mm + 6 mm = 12 mm
- 2. Side adjustment with elongated hole: 6 mm
- 3. Tilt adjustment with eccentric screw: 3 mm

Tilt adjustment

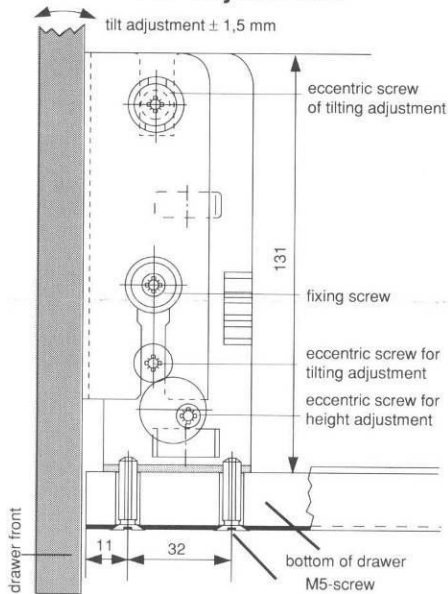

Mounting of drawer front :

- 1. Fixing of front through horizontal holes gives possibility of side adjustment.
 - 2. When front is adjusted put fixing screws into round holes.
- All adjustments can be done infinitely and may be locked anywhere.



08A-17920

Finish: powder coated
Colours: cream
Packing unit: 20 sets

Full Extension Drawer Slide – KV GS4205

Item #	Description	Finish	Pack.
08C-20010GS	KV GS4205 10"	Zinc	10 Sets
08C-20012GS	KV GS4205 12"	Zinc	10 Sets
08C-20014GS	KV GS4205 14"	Zinc	10 Sets
08C-20016GS	KV GS4205 16"	Zinc	10 Sets
08C-20018GS	KV GS4205 18"	Zinc	10 Sets
08C-20020GS	KV GS4205 20"	Zinc	10 Sets
08C-20022GS	KV GS4205 22"	Zinc	10 Sets
08C-20024GS	KV GS4205 24"	Zinc	10 Sets
08C-20026GS	KV GS4205 26"	Zinc	10 Sets
08C-20028GS	KV GS4205 28"	Zinc	10 Sets



- **90lb** class medium duty side mount unit with telescopic movement on ball bearings
- 32mm and traditional hole patterns
- lever disconnect and non-handed design
- also available in black finish
- maximum drawer width 24"
- 1" overtravel

Precision Slides - KV 8505

140 lb Load Rating (maximum 30" drawer width) – 150lb for KV8500

KV Heavy-duty Precision Slides for pedestal and lateral file drawers

Anochrome Finish

Full Extension with 1-1/2" Overtravel

Clearance per side 1/2" + 1/32" -0"

Item #	Description	Finish	Pack.
08C-30012	KV 8505 12"	Anochrome	1/5 Sets
08C-30014	KV 8505 14"	Anochrome	1/5 Sets
08C-30016	KV 8505 16"	Anochrome	1/5 Sets
08C-30018	KV 8505 18"	Anochrome	1/5 Sets
08C-30020	KV 8505 20"	Anochrome	1/5 Sets
08C-30022	KV 8505 22"	Anochrome	1/5 Sets
08C-30024	KV 8505 24"	Anochrome	1/5 Sets
08C-30026	KV 8505 26"	Anochrome	1/5 Sets
08C-30028	KV 8505 28"	Anochrome	1/5 Sets
08C-30030	KV 8505 30"	Anochrome	1/5 Sets

- package 1 set per poly bag with screws and instructions
- also available in black (special order)

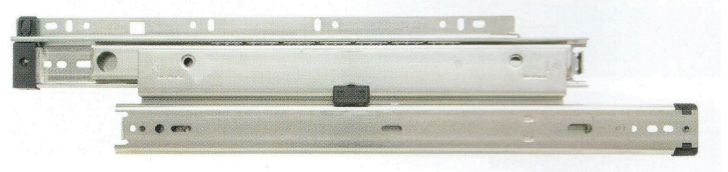

Precision Slides – KV8605 Heavy Duty Overtravel

140lb load rating

Maximum drawer width 36"

Clearance per side .51"

Item #	Finish	Description	Pack.
08C-31012	Zinc	Heavy Duty Overtravel 12"	5 Sets
08C-31014	Zinc	Heavy Duty Overtravel 14"	5 Sets
08C-31016	Zinc	Heavy Duty Overtravel 16"	5 Sets
08C-31018	Zinc	Heavy Duty Overtravel 18"	5 Sets
08C-31020	Zinc	Heavy Duty Overtravel 20"	5 Sets
08C-31022	Zinc	Heavy Duty Overtravel 22"	5 Sets
08C-31024	Zinc	Heavy Duty Overtravel 24"	5 Sets
08C-31026	Zinc	Heavy Duty Overtravel 26"	5 Sets
08C-31028	Zinc	Heavy Duty Overtravel 28"	5 Sets

Heavy-Duty Slides - KV 8810

Item #	Finish	Description	Pack.
08C-98812	Zinc	Heavy Duty Full Ext. 12"	4 Sets
08C-98814	Zinc	Heavy Duty Full Ext. 14"	4 Sets
08C-98816	Zinc	Heavy Duty Full Ext. 16"	4 Sets
08C-98818	Zinc	Heavy Duty Full Ext. 18"	4 Sets
08C-98820	Zinc	Heavy Duty Full Ext. 20"	4 Sets
08C-98822	Zinc	Heavy Duty Full Ext. 22"	4 Sets
08C-98824	Zinc	Heavy Duty Full Ext. 24"	4 Sets
08C-98826	Zinc	Heavy Duty Full Ext. 26"	4 Sets
08C-98828	Zinc	Heavy Duty Full Ext. 28"	4 Sets

- **200lb** load rating
- quick disconnect drawer members are non-handed
- side clearance is .75" per side (+.030, -.000)
- designed for use in drawers up to 42" wide
- Special order

Stainless Steel Full Extension Slides - KV6400

Item #	Finish	Description	Pack.
08C-64016	304 SS	Stainless Steel 16" Full Ext.	5 Sets
08C-64018	304 SS	Stainless Steel 18" Full Ext.	5 Sets
08C-64020	304 SS	Stainless Steel 20" Full Ext.	5 Sets
08C-64022	304 SS	Stainless Steel 22" Full Ext.	5 Sets

- **75lb** capacity
- non handed full extension
- clearance .51" per side
- supplied complete with stainless steel screws
- ideal for boats, laboratories and wash down environments
- Special order

Push to Open - GS 4260

- GS 4260 is ideal for Euro styled inset drawer fronts with no pulls, knobs or handles
- It can also be used for overlay drawer fronts provided at least 1/8" clearance is allowed for activation of the push-to-open mechanism
- **100lb**, full extension, available in 10" to 28"

Item #	Description	Finish	Pack.
08C-27016GS	GS 4260 - 16	Zinc	10 sets
08C-27018GS	GS 4260 - 18	Zinc	10 sets
08C-27020GS	GS 4260 - 20	Zinc	10 sets
08C-27022GS	GS 4260 - 22	Zinc	10 sets

Extra Heavy-Duty Slides - KV 8900

Item #	Finish	Description	Pack.
08C-98912	Zinc	Extra Heavy Duty Full Ext. 12"	4
08C-98914	Zinc	Extra Heavy Duty Full Ext. 14"	4
08C-98916	Zinc	Extra Heavy Duty Full Ext. 16"	4
08C-98918	Zinc	Extra Heavy Duty Full Ext. 18"	4
08C-98920	Zinc	Extra Heavy Duty Full Ext. 20"	4
08C-98922	Zinc	Extra Heavy Duty Full Ext. 22"	3
08C-98924	Zinc	Extra Heavy Duty Full Ext. 24"	3
08C-98926	Zinc	Extra Heavy Duty Full Ext. 26"	3
08C-98928	Zinc	Extra Heavy Duty Full Ext. 28"	3
08C-98930	Zinc	Extra Heavy Duty Full Ext. 30"	2
08C-98932	Zinc	Extra Heavy Duty Full Ext. 32"	2
08C-98934	Zinc	Extra Heavy Duty Full Ext. 34"	2
08C-98936	Zinc	Extra Heavy Duty Full Ext. 36"	2
08C-98940	Zinc	Extra Heavy Duty Full Ext. 40"	1
08C-98942	Zinc	Extra Heavy Duty Full Ext. 42"	1
08C-98948	Zinc	Extra Heavy Duty Full Ext. 48"	1
08C-98960	Zinc	Extra Heavy Duty Full Ext. 60"	1

- extra heavy-duty based on application
 - Modest use - 500 lb
 - Normal use - 400 lb
 - Vehicular use - 300 lb
 - Flat Mount use - 180 lb
- clearance is .750" (+.030, -0.000)
- non-metallic open and closed stops assure silent operation

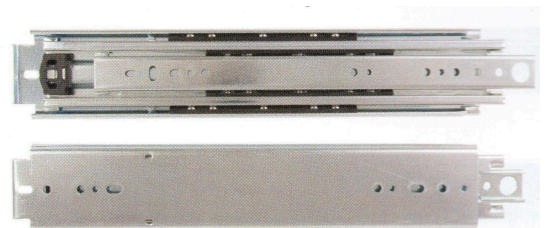

Extra Heavy-Duty Slides - Locking

Description	Finish
KV 8908 - Lock In/Lock Out	Zinc
KV 8909 - Lock Out only	Zinc
KV 8910 - Lock In only	Zinc

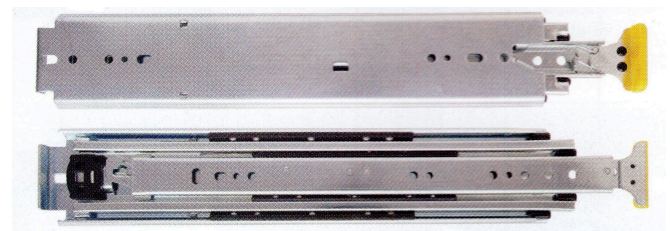

Soft-Close Full Extension Drawer Slides – GS4270

Item #	Description	Finish	Pack.
08C-21012GS	KV GS4270 12"	Zinc	10 Sets
08C-21014GS	KV GS4270 14"	Zinc	10 Sets
08C-21016GS	KV GS4270 16"	Zinc	10 Sets
08C-21018GS	KV GS4270 18"	Zinc	10 Sets
08C-21020GS	KV GS4270 20"	Zinc	10 Sets
08C-21022GS	KV GS4270 22"	Zinc	10 Sets
08C-21024GS	KV GS4270 24"	Zinc	10 Sets
08C-21026GS	KV GS4270 26"	Zinc	10 Sets
08C-21028GS	KV GS4270 28"	Zinc	10 Sets

- **100lb** full extension 16"-28" featuring soft close technology
- Less than full extension 12"=8.4" ext; 14"=11.9" ext
- Delivering an ultra smooth slide operation and soft close dampening effect
- lever disconnect and non-handed design
- clearance .50" + .03" - .0"



Full Extension Drawer Slides - CGS 120lb

Item #	Description	Finish		Pack.
08C-20110	CGS Full Ext. 10"	Zinc	"	10 Sets
08C-20112	CGS Full Ext. 12"	Zinc	"	10 Sets
08C-20114	CGS Full Ext. 14"	Zinc	"	10 Sets
08C-20116	CGS Full Ext. 16"	Zinc	"	10 Sets
08C-20118	CGS Full Ext. 18"	Zinc	"	10 Sets
08C-20120	CGS Full Ext. 20"	Zinc	"	10 Sets
08C-20122	CGS Full Ext. 22"	Zinc	"	10 Sets
08C-20124	CGS Full Ext. 24"	Zinc	"	10 Sets
08C-20126	CGS Full Ext. 26"	Zinc	"	10 Sets
08C-20128	CGS Full Ext. 28"	Zinc	"	10 Sets

- Height: 45.2mm
- Side clearance: 12.7mm +/- .2mm

Soft Close Full Extension Drawer Slides - CGS 100lb

Item #	Description	Finish		Pack.
08C-21212	CGS Full Ext. Soft Close 12"	Zinc	"	10 Sets
08C-21214	CGS Full Ext. Soft Close 14"	Zinc	"	10 Sets
08C-21216	CGS Full Ext. Soft Close 16"	Zinc	"	10 Sets
08C-21218	CGS Full Ext. Soft Close 18"	Zinc	"	10 Sets
08C-21220	CGS Full Ext. Soft Close 20"	Zinc	"	10 Sets
08C-21222	CGS Full Ext. Soft Close 22"	Zinc	"	10 Sets
08C-21224	CGS Full Ext. Soft Close 24"	Zinc	"	10 Sets

- Height: 45.2mm
- Side clearance: 12.7mm +/- .2mm

Pocket Door Slides - KV8092 4x4

Item #	Finish	Description	Pack.
08K-34018	Black	KV8091 4x4 Pocket Door 18"	Each
08K-34020	Black	KV8091 4x4 Pocket Door 20"	Each
08K-34022	Black	KV8091 4x4 Pocket Door 22"	Each
08K-34024	Black	KV8091 4x4 Pocket Door 24"	Each
08K-32136	Black	KV8092SB Shaft 36"	2
08K-32148	Black	KV8092SB Shaft 48"	2
08K-32172	Black	KV8092SB Shaft 72"	2
08K-34200	Black	KV8080 Hinge Pack -Standard	2
08K-34203	Black	KV8091 Full overlay kit	2
08K-33000	Cream	KV 8090 Raised Panel Door Roller	Each

Features:

Dual rack and pinion system virtually eliminates door sag

75 lb class rated for heavy duty applications

Maximum door dimensions: 72"h x 26"

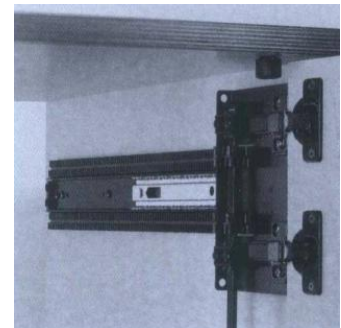

Wooden Drawer Guides

Item #	Finish	Description
08H-20016 G	Solid Wood	Drawer Guide 16" Groove
08H-20016 T	Solid Wood	Drawer Guide 16" Tongue
08H-20020 G	Solid Wood	Drawer Guide 20" Groove
08H-20020 T	Solid Wood	Drawer Guide 20" Tongue

- Tongue section 21mm wide x 13mm high
- Groove section 50mm wide x 14mm high

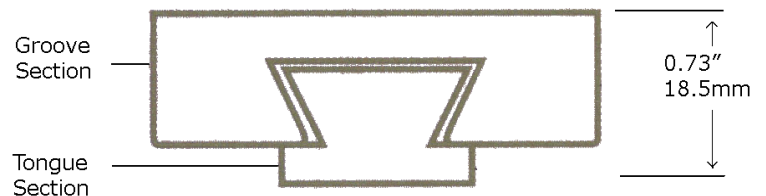

Section 10 • Furniture Locks

Table of Contents

Timberline Locks
Specialty Locks

Page 10.1
Page 10.5

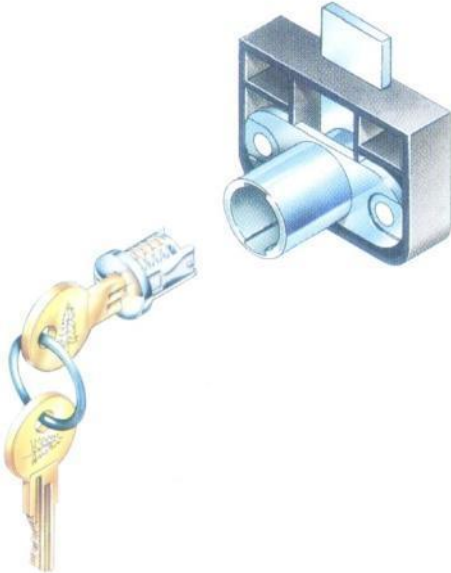

Timberline Locks, Removable Core System

Complete Keying Versatility

- In Plant ...furniture can be keyed easily to the customer's requirements at any time.
- In field...key numbers can be readily changed by your customer.

Ease of Finishing

- Furniture may be finished without lock plug installed, eliminating need for masking.

Simplified Inventory Management

- One stock of lock cores fulfills all locking requirements

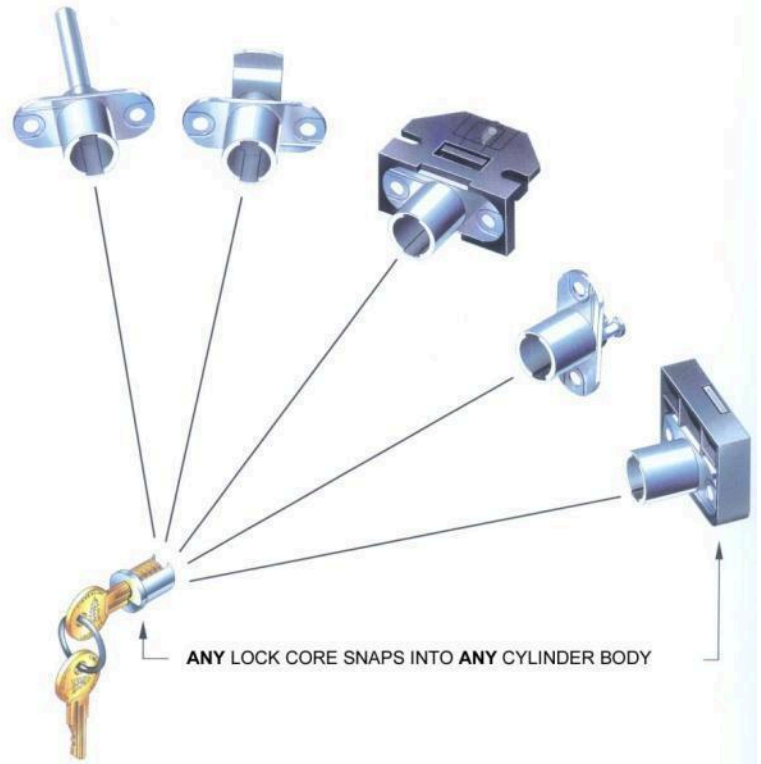

Item #	Description	Pack.
Lock Cores (100TA-109TA)		
10T-11000	Lock Core NP 100TA	Each/10
10T-15000	Lock Core NP Keyed Different	Each/10

- lock cores are available in other finishes (special order)



Timberline Locks, Removable Core System

Item #	Description	Pack.
10T-21000	Front Gang CB-100	Each/10
10T-21500	Side Gang CB-150	Each/10



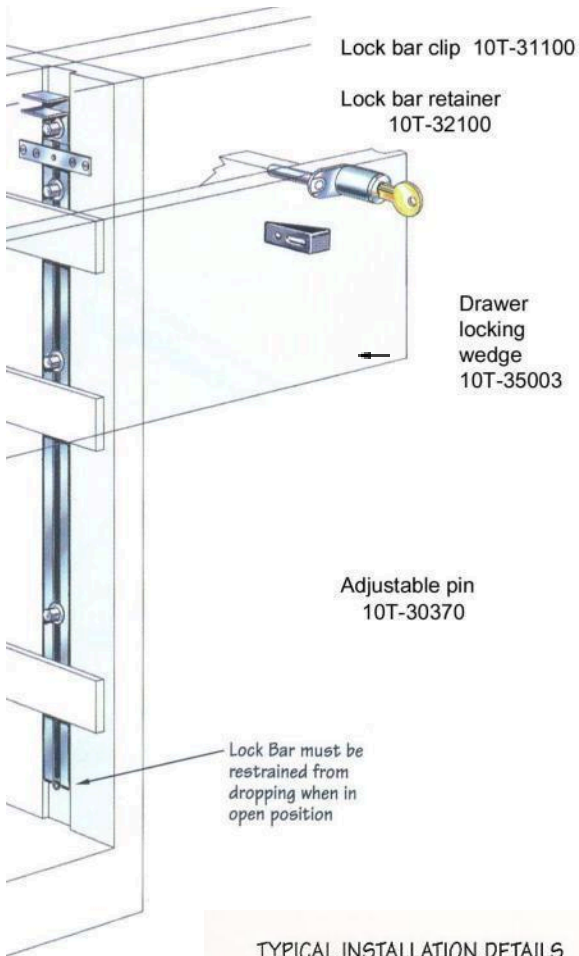

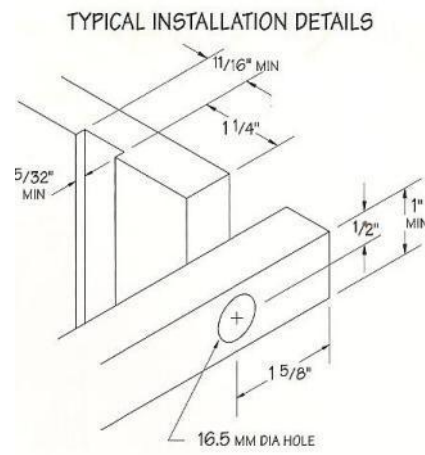
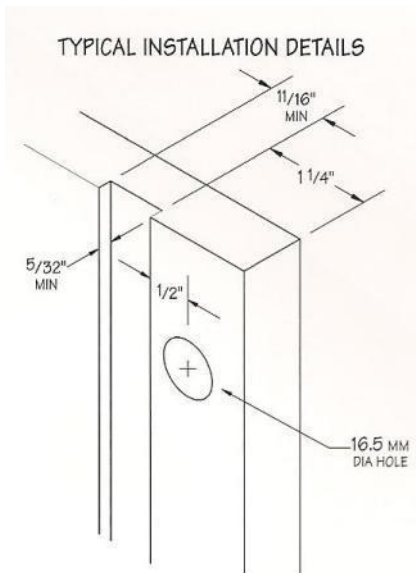

**Front Mounted Gang Lock
For Multiple Drawers**



**Side Mounted Gang Lock
For Multiple Drawers**



Timberline Locks, Removable Core System

Item #	Description		Pack.
Cylinder Bodies			Each/10
10T-20000	Cam Horizontal 180° rotation CB-184		Each/10
10T-20100	Cam Vertical 180° rotation CB-194		Each/10
10T-21700	Thick Panel Lock CB-170		Each/10
10T-21753	Push (Black) CB-175		Each/10
10T-22350	Drawer Offset CB-235		Each/10
10T-22500	Double Door Lock CB-250		Each/10
10T-22600	Double Door Lock CB-255 (Opposite Mount)		Each/10

Timberline Locks, Removable Core System

Item #	Description	Pack
Cylinder Bodies		
10T-22700	2 Drawer Central CB-270	Each/10
10T-22800	Drawer Deadbolt CB-280	Each/10
10T-22900	RH/LH Deadbolt CB-290	Each/10



Timberline Locks, Removable Core System

Item #	Description	Pack.
Accessories		
10T-30370	Adjustable Pin 9.5mm	Each/10
10T-31000	Rosette NP	Each/10
10T-31100	Lock Bar Clip Front Mount	Each/10
10T-31500	Lock Bar Clip Side Mount	Each/10
10T-32100	Lock Bar Retainer	Each/10
10T-32400	Lock Bar 609mm	Each/10
10T-32553	Strike Plate Black	Each/10
10T-32573	Strike Plate Black Double Door	Each/10
10T-33003	Rosette Black	Each/10
10T-33193	Strike Plate Angled Black	Each/10
10T-35003	Drawer Locking Wedge	Each/10
10T-36040	Strike Plate NP Screw On	Each/10
10M-90850	Lock stopper, plastic	1000
10M-90860	Angled striker plate	50
10T-95000	Removal Key for TA Series	Each
10T-95001	Master Key for TA	Each
10T-95010	Drill Bit 16.5 mm R/H	Each



Lock stopper



Angled Striker Plate

Specialty Locks

Half Mortise Lock Dead Bolt (985)

Item #	Description	Pack.
10D-20100	Half Mortise Lock, keyed different	
10D-20149	Half Mortise Lock, key # 549	

- finish - brass (others to special order)
- keying - N54G - brass milled keys
- key removes in locked and unlocked positions
- half mortise lock (984) with spring latch (instead of dead) also available to special order

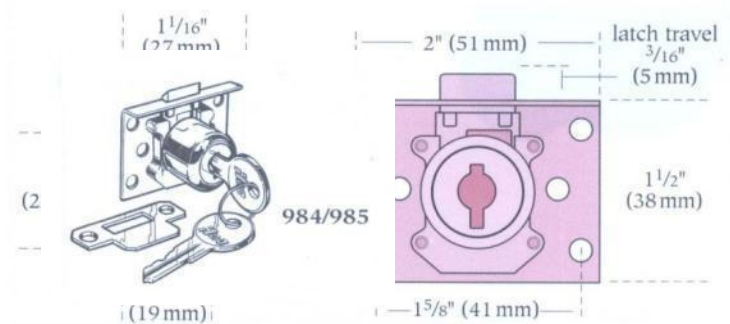

Show Case Lock

Item #	Description	Pack.
10D-96550	Show Case Lock, Key #50, KA	1/12

- adjustable 1" to 3-3/8"
- adjustable for 1/4" sliding glass doors
- finish - nickel
- disc tumbler

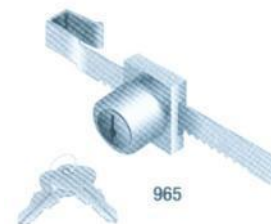

Miscellaneous Locks

Item #	Description	Pack.
10D-60000	Mortise cabinet lock	Each

- for general use on doors and drawers
- 3-way keyhole
- brass face and key, full mortise



Section 11 • Ergonomic Products

Table of Contents

Desktop Sit - Stand Workstation	Page 11.1
Ascent3 Table Frame Kits	Page 11.2
Concerto Monitor Supports	Page 11.3



Ergonomic Products are supplied through Knap and Vogt
and all their products are readily available to us.

Further details can be found at
www.knapandvogt.com Ergonomic Solutions Distribution Catalog

Volante Desktop Sit-Stand Workstation

The Volante Sit-Stand Desktop Workstation, quickly and economically converts an existing desk to a smooth and effortless sit-stand workstation.

Volante desktop sit-stand workstation

- Primary work surface can extend 20" above the desk
- Gas assisted infinite height adjustment range of 13.8"
- Large primary work surface, fits 2 x 24" monitors, KV monitor arms, Apple iMac or laptop with monitor
- Grommet hole for monitor arm or cable management
- 20° keyboard surface tilt, -10°/+10° for ergonomic typing
- Clip-on mouse fence and cable manager
- Supports 35 lbs. of technology
- Fits onto a 24" deep desk
- Ships fully assembled



Volante HD42 desktop sit-stand workstation

- Primary work surface can be extended 20" above the desk
- Gas assisted single paddle infinite height adjustment range of 13.8"
- 42" large primary work surface, fits 2 x 27" monitors, KV monitor arms, Apple iMac or laptop with monitor
- Three grommet holes for monitor arm or cable management
- 20° keyboard surface tilt, -10°/+10° for ergonomic typing
- Clip-on mouse fence and cable manager
- Supports 45 lbs. of technology
- Fits onto a 24" deep desk
- Ships fully assembled



Ascent3 Height Adjustable Table Frame Kits

A height adjustable table solution for customers who want office ergonomics at a competitive market price. A quiet alternative between sitting and standing positions reducing strain and tension while improving circulation for better health. This simple expandable base design fits a wide array of user tops in various widths and depths and is programmable to 4 memory settings.

Ascent3 - Rectangular 2 leg/3 stage table

Item #	Description	Pack.
11B-45000	Silver, 24" foot size	1

- 26" height adjustable range,
- digital readout programmable memory switch with 4 memory settings
- 58 dB noise level for quiet operation
- 1.2" per second height adjustment speed for quick adjustment
- Adjustable to fit table top widths from 42" to 78" wide and 23" to 30" deep (not included)
- Payload carry capacity: 200 lb (after top)
- Gross load capacity 330 lb (not including top and safety factor)
- 8' power cord
- Maximum current draw: 4 A at 120 V/60 Hz
- Standby power: 0.3 W
- Meets or exceeds BIFMA X5.5 standards
- UL recognized controls
- 5 year warranty



* table top not included

Ascent3 - "L" shaped 3 leg/3 stage table - available early 2024

Item #	Description	Pack.
11B-	Silver, 24" foot size	1



Concerto Monitor Supports

Item #	Description	Pack.
11C-447825S	Monitor Support	1

- dual screen
- beam mount (no extension arms)
- includes two quick connect adapter brackets and 12" pole
- two 10" beam segments
- max 20" screen width



Item #	Description	Pack.
11C-447820SD12	Monitor Support	1

- dual screen
- two dual extension arms each with one standard length fixed segment + one height adjustable segment, joined together with the dual hub
- included two quick connect adapter brackets and 12" pole
- max 39" screen width
- grommet only



Keyboard Tray with Mouse Tray - KV 5710

Item #	Colour	Description	Pack.
11C-40021	Black	KV 5710 SP complete with mouse tray	1 Set

- 3/4 Extension, 75 lb load rating
- 3 precision steel ball bearings per inch of ball race for smooth, quiet movement and durability
- Mounting brackets adjust to seven different heights and can be reversed for inbound or outbound mounting
- Tray lock-in and lock-out. Friction latch holds tray securely in an open position while permitting easy closure
- Tray member quickly disconnects using positive lever release
- Ergonomic, height adjustable cushioned wrist rest (five positions)
- Keyboard tray and mouse tray are cold rolled steel
- Wrist rest is a textured PVC compound
- Mouse tray opens to either left or right side

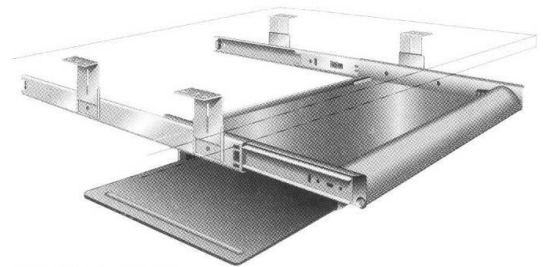

Adjustable Keyboard Arm/Comfort Keyboard Tray

Item #	Description	Pack.
11C-42025	Adjustable keyboard Arm	1

- 18" track with EZ-Glide system
- Swivel tilt mouse platform accommodates right or left hand mousing



Section 12 • Tools & Machines

Table of Contents

Driver Bits	Page 12.1
Drill Bits	Page 12.2
CMT Sawblades & Router Bits	Page 12.5
Edge trimmers	Page 12.6
Miscellaneous	Page 12.6



Full line catalogue available online
www.cmtusa.com

Pozi Drive Driver Bits

Item#	Overall length	Point size	Pack.
12A-11178	2"	2	10
12A-11179	2"	3	10



Robertson Driver Bits

Item#	Screw size	Overall length	Point size	Pack.
12A-21020	#3, 4	1"	0	25
12A-11362	#5, 6, 7	1-15/16"	1	10
12A-11363	#8, 10	1-15/16"	2	10
12A-11367	#8, 10	3"	2	10
12A-11347	#12, 14	3"	3	10
12A-11356	#12, 14	6"	3	10
12A-11357	#3, 4	1"	0	25
12A-11358	#5, 6, 7	1"	1	25
12A-11359	#8, 10	1"	2	25
12A-11351	#12, 14	4"	3	10
12A-12160	#5, 6, 7	6"	1	
12A-12240	#8, 10	4"	2	10
12A-12260	#8, 10	6"	2	



11362

Bit Holders

Item#	Overall length	Point size	Pack.
12A-11501	2-1/4"	2	1



MAGNETIC

Pozi Drive Screw Drivers

Item#	Overall length	Point size	Pack.
12A-98412	7-3/4"	2	1

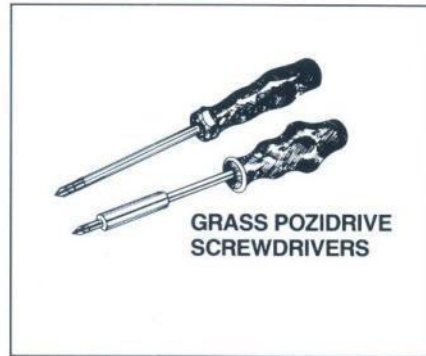

Carbide Drill Bits

Item#	Diameter	Hand	Used For	Pack.
12A-00051	5mm	Left	System Drilling	1
12A-00052	5mm	Right	System Drilling	1
12A-00071	7mm	Left	Confirmat Pilot Holes	1
12A-00072	7mm	Right	Confirmat Pilot Holes	1
12A-00081	8mm	Left	System Drilling	1
12A-00082	8mm	Right	System Drilling	1
12A-00101	10mm	Left	System Drilling	1
12A-00352	35mm	Right	Euro Hinge - Standard	1
12A-00402	40mm	Right	Euro Hinge - Thick Door	1

CMT
For top
quality bits



CMT Orange Tools

CMT manufacturers a wide range of industrial cutting and boring tools for the production workshop, cabinet maker and fine woodworker.

The combination of micrograin carbide, the Orange PTFE coating and the finest industrial strength steel makes CMT products a leader in cutting tools.

Visit CMT website at www.cmtusa.com

CMT Sawblades

Item #	Description
12E-20303010	CMT Glue Line Ripping Blade
12E-21008010	CMT Fine Cut off Blade
12E-21304010	CMT The General PTFE Coated
12E-21908010	CMT Miter/Radial Arm Blade
12E-22106010	CMT Cabinetshop Blade PTFE Coated



Blade and Bit Cleaner

Item #	Description
12E-99800101	CMT Formula 2050



Miscellaneous

Item #	Description	Pack.
12C-20000	FastCap AccuScribe Pro	Each
12C-20400	5 Meter Metric Measuring Tape	Each
12C-20416	FastCap 16' Measuring Tape	Each
12C-20500	FastCap Fat Boy Pencil	Each
12C-50000	FastCap Hole Punch Kit	Each
12C-60050	Edge Trimmer - Double	Each
12C-60060	Blade For Double Edge Trimmer	Each
12C-20010	Speed Roller	Each
12C-20100	Fastcap Drill Bit	Each
12C-20300	Little Hand	Each
12C-40000	Winbag	Each



12C-60050

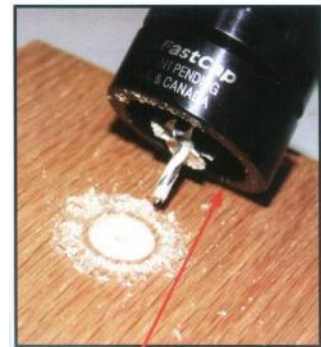

Ball bearing stop collar prevents surface marring!

12C-20100



12C-20300



12C-50000







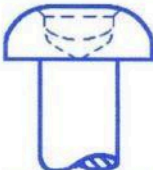

For all FastCap items available, visit www.fastcap.com

Section 13 • Fasteners



Table of Contents

The MAXX	Page 13.1
Washer Head Screws	Page 13.1
Screws #6	Page 13.2
Screws #8	Page 13.3
Installation Screws	Page 13.5
Euro Screws	Page 13.5
Confirmat Screws	Page 13.5
Screw Caps	Page 13.6
Cover Caps	Page 13.7
Hole Plugs	Page 13.7
Staples & Brads	Page 13.8
Fasteners	Page 13.10

		
PAN HEAD	ROUND HEAD	TRUSS HEAD
		
FLAT HEAD	OVAL HEAD	FLAT HEAD (UNDERCUT)
		
ROUND WASHER HEAD	SPECIAL INSTALLATION HEAD (CABINET)	INDENTED HEX HEAD

Comments

Screws are also available in #4, #5, #10, #12, #14 sizes to special order.

Screws may be waxed (lubricated) for easy insertion and increased rust resistance (special order).

Lo-Root screws sometimes referred to as Deep-Root.







Standard drive for the screws is square socket



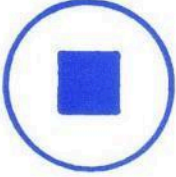





Socket Size

- 0
- 1
- 2

Screw Size

- #3, #4
- #5, #6
- #8, #10

	
SQUARE SOCKET	PHILLIPS (TYPE 1)
	
SQUARE SLOTTED	PHILLIPS SLOTTED
	
POZI	INDENTED HEX

		
SHEET METAL (TYPE A)	SHEET METAL (TYPE AB)	SHEET METAL (TYPE B)
		
LOW ROOT	DOUBLE LEAD (WOOD SCREW)	PILOT POINT
		
MACHINE	MACHINE (TYPE C: SELF-TAPPING)	DOG POINT

Screws

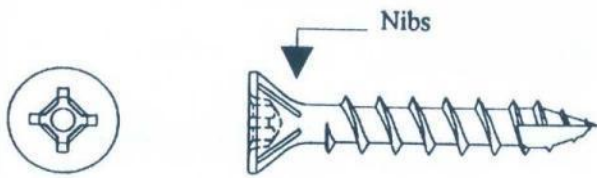

"THE MAXX"
FLAT RECEX (ROBERTSON/PHILLIPS)
LO-ROOT TYPE 17 WOOD SCREWS

Size	Lub.	Zinc	Bulk Pack.
#8 x 1"	13A-23306	13A-23406	10M
#8 x 1-1/4"	13A-23308	13A-23408	7.5M
#8 x 1-1/2"	13A-23310	13A-23410	5M
#8 x 1-3/4"	13A-23312	13A-23412	4M
#8 x 2"	13A-23313	13A-23413	3.5M
#8 x 2-1/4"	13A-23314	13A-23414	2.5M
#8 x 2-1/2"	13A-23315	13A-23415	2.5M
#8 x 2-3/4"	13A-23316	13A-23416	2M
#8 x 3"	13A-23317	13A-23417	1.5M

- recex drive system combines square recess for non-slip fastening in production use and Phillips for after market serviceability
- self-countersinking nibs under head eliminate pre-boring
- lubricized for quicker installation
- Lo-Root thread design for optimum holding power
- Type 17 point designed to reduce material splitting and provide easier penetration

Washer Head Screws

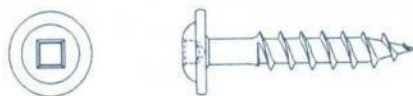

Size	Zinc.	Bulk Pack.
#8 x 1" LWH	13B-23506	7M
#8 x 1-1/8" LWH Type 17 Tip	13B-23507	6M

- Lo-Root zinc
- make economical door front adjusters
- round washer head screws also available In painted white, hard rock maple and choc.pear tree

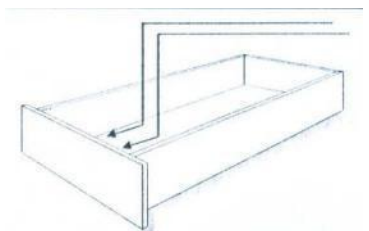

Size	Zinc.	Bulk Pack.
#8x1-1/4" Type 17 Tip	13B-23508	6M
#8x2-1/2" Type 17 Tip	13B-23515	2.5M

- Pocket hole screws (Kreg system)

6 - #7 Screws



<u>Flathead Zinc</u>		<u>Lo-Root</u>	<u>Bulk Pack</u>
Screw #6 x 1/2"	FH Soc. #2	13B-22002	15M
Screw #6 x 5/8"	FH Soc. #2	13B-22003	15M
Screw #6 x 5/8" #5 Head	FH Soc.	12B-22023	15M
Screw #6 x 3/4"	FH Soc. #2	13B-22004	10M
Screw #6 x 1"	FH Soc. #2	13B-22006	12M
Screw #6 x 1-1/4"	FH Soc. Type 17/Nibs #2	13B-22008	8M
Screw #6 x 1-1/2"	FH Soc. Type 17/Nibs #2	13B-22010	7M
Screw #6 x 1-3/4"	FH Soc. Type 17/Nibs #2	13B-22012	5M
Screw #7 x 5/8"	FH Soc. No Nibs #2	13B-27003	15M

<u>Panhead Zinc</u>		<u>Lo-Root</u>	<u>Bulk Pack</u>
Screw #6 x 1/2"	PH Soc.	13B-22202	15M
Screw #6 x 5/8"	PH Soc.	13B-22203	15M
Screw #6 x 3/4"	PH Soc.	13B-22204	12M
Screw #6 x 7/8"	PH Soc.	13B-22205	12M
Screw #6 x 1"	PH Soc.	13B-22206	12M
Screw #6 x 1-1/8"	PH Soc.	13B-22207	10M
Screw #6 x 1-1/4"	PH Soc.	13B-22208	8M
Screw #6 x 1-1/2"	PH Soc.	13B-22210	7M
Screw #6 x 1-3/4"	PH Soc.	13B-22212	6M
Screw #6 x 2"	PH Soc.	13B-22213	7M

- wood screws shorter than 1" are supplied as wood tapping screws.(full thread)
- wood screws that are greater than 1" are threaded 2/3 their length.(For full thread wood screws, please inquire)
- bare screws available to special order

<u>Trusshead Zinc</u>		<u>Wood Screw</u>	<u>Bulk Pack</u>
Screw #6 x 3/8"	TH Soc.	13B-12401	20M
Screw #6 x 1/2"	TH Soc.	13B-12402	15M

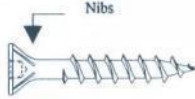

#8 Screws

				
<u>Flathead Zinc</u>		<u>Wood Screw</u>	<u>Lo-Root</u>	<u>Bulk Pack</u>
Woodscrew #8 x 1/2"	FH Soc.	13B-13002	13B-23002	15M
Woodscrew #8 x 5/8"	FH Soc.	13B-13003	13B-23003	15M
Woodscrew #8 x 3/4"	FH Soc.	13B-13004	13B-23004	12M

			<u>Zinc</u>	<u>Bulk Pack</u>
<u>Flathead with nibs</u>		<u>Bare</u>	<u>Zinc</u>	<u>Bulk Pack</u>
Lo-Root nibs #8 x 1" FH Soc.		13D-23806	13F-23806	10M
Lo-Root nibs #8 x 1-1/8" FH Soc.		13D-23807	13F-23807	8M
Lo-Root nibs #8 x 1-1/4" FH Soc.		13D-23808	13F-23808	7.5M
Lo-Root nibs #8 x 1-1/2" FH Soc.		13D-23810	13F-23810	5M
Lo-Root nibs #8 x 1-3/4" FH Soc.		13D-23812	13F-23812	4M
Lo-Root nibs #8 x 2" FH Soc.		13D-23813	13F-23813	3.5M
Lo-Root nibs #8 x 2-1/2" FH Soc.		13D-23815	13F-23815	3M
Lo-Root nibs #8 x 3" FH Soc.		13D-23817	13F-23817	2M

- screws shorter than 1" are supplied as tapping screws.
- screws that are greater than 1" are threaded 2/3 their length.

#8 Screws

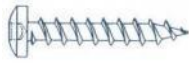
 <u>Panhead Zinc</u>		 <u>Wood Screw</u>	 <u>Lo-Root</u>	<u>Bulk Pack</u>
Woodscrew #8 x 1/4"	PH Soc.	13B-13200	13B-23200	15M
Woodscrew #8 x 3/8"	PH Soc.	13B-13201	13B-23201	15M
Woodscrew #8 x 1/2"	PH Soc.	13B-13202	13B-23202	12M
Woodscrew #8 x 5/8"	PH Soc.	13B-13203	13B-23203	10M
Woodscrew #8 x 3/4"	PH Soc.	13B-13204	13B-23204	10M
Woodscrew #8 x 7/8"	PH Soc.	13B-13205	13B-23205	8M
Woodscrew #8 x 1"	PH Soc.	13B-13206	13B-23208	8M
Woodscrew #8 x 1-1/8"	PH Soc.	13B-13207	13B-23207	7M
Woodscrew #8 x 1-1/4"	PH Soc.	13B-13208	13B-23208	7M
Woodscrew #8 x 1-1/2"	PH Soc.	13B-13210	13B-23210	5M
Woodscrew #8 x 1-3/4"	PH Soc.	13B-13212	13B-23212	4M
Woodscrew #8 x 2"	PH Soc.	13B-13213	13B-23213	4M
Woodscrew #8 x 2-1/4"	PH Soc.	13B-13214	13B-23214	4M
Woodscrew #8 x 2-1/2"	PH Soc.	13B-13215	13B-23215	3M
Woodscrew #8 x 3"	PH Soc.	13B-13217	13B-23217	2.5M

- screws shorter than 1" are supplied as tapping screws.
- screws that are greater than 1" are threaded 2/3 their length.
- bare screws available to special order

**Introducing the NEWEST member of the
Robertson® family of fasteners
CAB MAXX™ INSTALL CABINET SCREW**

Item #	Description	Bulk Pack.
13L-00008	Power Head Screw 1-1/4"	2M
13L-00010	Power Head Screw 1-1/2"	2M
13L-00013	Power Head Screw 2"	2M
13L-00015	Cab Maxx #8 x 2-1/2"	2.5M
13L-00017	Cab Maxx #8 x 3"	1.5M
13L-00019	Cab Maxx #8 x 3-1/2"	1M

- Lo Root, Zinc
- Type 17
- #2 Robertson Drive
- 8 countersinking nibs



Screws

Installation Screws



		<u>Lo-Root</u>	<u>Bulk Pack</u>
Installation #8 x 1 1/8"	FH Soc.	13A-23707	8M
Installation #8 x 1 1/4"	FH Soc.	13A-23708	7M
Installation #8 x 1 3/4"	FH Soc.	13A-23712	4M
Installation #8 x 2 1/2"	FH Soc.	13A-23715	2M
Installation #8 x 3"	FH Soc.	13A-23717	2.5M

Euro Screws / System Screws

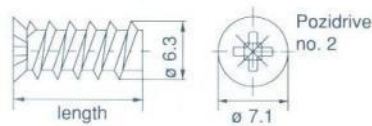

		<u>Code</u>	<u>Bulk Pack</u>
Euro Screws 5mmx9.5mm	FH Zinc #2 POZI Drive	13L-40000	1/10M
Euro Screws 5mmx13mm	FH Zinc #2 ROB Drive	13L-40005	1/10M

Confirmat Screws



		<u>Code</u>	<u>Bulk Pack</u>
Confirmat Screws 7mmx50mm – Pozi Drive		13L-30000	2M
Confirmat Screws 5mmx50mm –Pozi Drive Pointed Tip		13L-30002	

Screws Caps

Pin Caps for #2 Robertson Screws

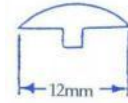

	<u>Colour</u>	<u>Code</u>	<u>Pack</u>
Screw Cap #2	Black	13H-10004	1000
Screw Cap #2	Grey	13H-10010	1000
Screw Cap #2	White	13H-10028	1000/5000
Screw Cap #2	Butterscotch	13H-10030	1000

Cover Caps for #8 Installation Screws

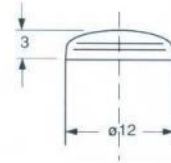

Installation caps	White	13H-10128	1000/5000
-------------------	-------	-----------	-----------

Pin Caps for Pozidrive Confirmat Screws

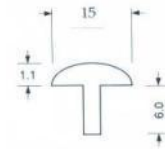

Confirmat Cap	Almond	13H-20000	1000
Confirmat Cap	Black	13H-20004	1000
Confirmat Cap	Brown	13H-20006	1000
Confirmat Cap	Grey	13H-20010	1000

Cover Caps

Item #	Description	Pack.
PVC Solid Colour		
13H-11001	Fastcap White	52/Sheet
13H-11002	Fastcap Antique White	52/Sheet
13H-11003	Fastcap Almond	52/Sheet
13H-11004	Fastcap Black	52/Sheet
13H-11005	Fastcap Fog Grey	52/Sheet
13H-11006	Fastcap Folkstone Grey	52/Sheet
PVC Woodgrains		
13H-11008	Fastcap Golden Oak	52/Sheet
13H-11013	Fastcap Light Oak	52/Sheet
13H-11014	Fastcap Hard rock Maple	52/Sheet
13H-11017	Fastcap Light Maple	52/Sheet
13H-11020	Fastcap Natural Cherry	52/Sheet
13H-11022	Fastcap Medium Cherry	52/Sheet
13H-11030	Fastcap Dark Red Mahogany	52/Sheet
Veneer		
13H-11101	Fastcap Red Oak	52/Sheet
13H-11102	Fastcap White Oak	52/Sheet
13H-11103	Fastcap Maple	52/Sheet
13H-11104	Fastcap Cherry	52/Sheet
13H-11105	Fastcap Mahogany	52/Sheet
13H-11106	Fastcap Pine	52/Sheet
13H-11107	Fastcap White Birch	52/Sheet
13H-11109	Fastcap Walnut	52/Sheet
13H-11110	Fastcap VG Fir	52/Sheet
13H-11116	Fastcap Teak	52/Sheet

- diameter is 9/16" (14mm)



Hole Plugs

Item#	Description	Pack.
13H-30900	Hole Plug 5mm White	1000
13H-30901	Hole Plug 5mm Brown	1000
13H-30902	Hole Plug 5mm Black	1000
13H-30903	Hole Plug 5mm Pine	1000
13H-30904	Hole Plug 5mm Grey	1000
13H-30908	Cover Cap 13mm/8mm White	1000
07B-18000	Hinge Cover Cap 35mm White	100
07B-18001	Hinge Cover Cap 35mm Round Almond	1000
07B-18003	Hinge Cover Cap 35mm Brown	100

Staples - Galvanized

Item #	Gauge	Crown	Description	Pack.
13K-17100	18	7/32"	Staple 1"	5/50M
13K-17108	18	7/32"	Staple 1-1/2"	5/40M
13K-18008	18	1/4"	Staple 1/2"	5/80M
13K-18010	18	1/4"	Staple 5/8"	5/80M
13K-18012	18	1/4"	Staple 3/4"	5/80M
13K-18014	18	1/4"	Staple 7/8"	5/60M
13K-18100	18	1/4"	Staple 1"	5/60M
13K-18102	18	1/4"	Staple 1-1/8"	5/50M
13K-18104	18	1/4"	Staple 1-1/4"	5/40M
13K-18108	18	1/4"	Staple 1-1/2"	5/40M
13K-26104	16	Med	Staple 1-1/4"	20/60M

Brads - Galvanized

Item #	Gauge	Length	Description	Pack.
13K-76013	16	25/32"	Brad	5/60M
13K-76100	16	1"	Brad	5/60M
13K-76104	16	1-1/4"	Brad	2.5/30M
13K-76108	16	1-1/2"	Brad	2.5/30M
13K-76112	16	1-3/4"	Brad	2.5/30M
13K-76204	16	2-1/4"	Brad	2.5/30M
13K-76208	16	2-1/2"	Brad	2.5/30M
13K-78008	18	1/2"	Brad	5/100M
13K-78010	18	5/8"	Brad	5/100M
13K-78012	18	3/4"	Brad	5/100M
13K-78100	18	1"	Brad	5/100M
13K-78103	18	1-3/16"	Brad	5/100M
13K-78104	18	1-1/4"	Brad	5/100M
13K-78108	18	1-1/2"	Brad	5/60M
13K-78112	18	1-3/4"	Brad	5/60M
13K-78200	18	2"	Brad	5/60M

Brads and Headless Pins - 23 gauge

Item #	Gauge	Length	Description	Pack.
13K-82312	23	12mm	Brad	Box (4M)
13K-82315	23	15mm	Brad	Box (4M)
13K-82318	23	18mm	Brad	Box (4M)
13K-82321	23	21mm	Brad	Box (4M)
13K-82325	23	25mm	Brad	Box (4M)
13K-82330	23	30mm	Brad	Box (4M)
13K-82335	23	35mm	Brad	Box (4M)
13K-82340	23	40mm	Brad	Box (4M)
13K-82345	23	45mm	Brad	Box (4M)
13K-82350	23	50mm	Brad	Box (4M)
13K-92312	23	12mm	Headless Pin	Box (4M)
13K-92315	23	15mm	Headless Pin	Box (4M)
13K-92318	23	18mm	Headless Pin	Box (4M)
13K-92321	23	21mm	Headless Pin	Box (4M)
13K-92325	23	25mm	Headless Pin	Box (4M)
13K-92330	23	30mm	Headless Pin	Box (4M)
13K-92335	23	35mm	Headless Pin	Box (4M)
13K-92340	23	40mm	Headless Pin	Box (4M)
13K-92345	23	45mm	Headless Pin	Box (4M)
13K-92350	23	50mm	Headless Pin	Box (4M)

Fasteners

Joint Connector Bolt (JCB-B)

Made of steel with a bronze finish

Installed with a 4mm driver bit or allen/hex key

Item #	Finish	Description
13M-10230	Bronze	Joint connector bolt 1/4-20x30mm
13M-10235	Bronze	Joint connector bolt 1/4-20x35mm
13M-10240	Bronze	Joint connector bolt 1/4-20x40mm
13M-10245	Bronze	Joint connector bolt 1/4-20x45mm
13M-10250	Bronze	Joint connector bolt 1/4-20x50mm
13M-10280	Bronze	Joint connector bolt 1/4-20x80mm
13M-20230	Chrome	Joint connector bolt 1/4-20x30mm
13M-20235	Chrome	Joint connector bolt 1/4-20x35mm
13M-20240	Chrome	Joint connector bolt 1/4-20x40mm
13M-20245	Chrome	Joint connector bolt 1/4-20x45mm
13M-20250	Chrome	Joint connector bolt 1/4-20x50mm
13M-20260	Chrome	Joint connector bolt 1/4-20x60mm
13M-20270	Chrome	Joint connector bolt 1/4-20x70mm

- available in other finishes to special order
- joint connector screws also available



Joint Connector Cap (JCN)

Made of steel with a bronze finish

Designed as a cap nut with JCB-B connector bolt

13P-10212	Bronze	Cap Nut JCN 1/4-20x12mm
13P-10217	Bronze	Cap Nut JCN 1/4-20x17mm
13P-10317	Chrome	Cap Nut JCN 1/4-20x17mm

- available in other sizes and finishes



Allen / Hex Keys

Case hardened steel

Item #	Finish	Description
13P-80400	Black	4mm Drive



Fasteners

Insert Nuts - Type D - Hex drive **with** flange.

A zinc alloy die cast fitting designed to be screwed in by hand tool or machine
 Provides superior holding power in all wooden materials
 External split thread prevents surface expansion during insertion
 Low profile circular flange limits penetration and produces a finished appearance



Item #	Finish	Description
13N-30113	Zinc	Insert Nit D 1/4:20x13mm
13N-30120	Zinc	Insert Nut D 1/4:20x20mm

Insert Nuts - Type E - Hex drive **without** flange.

A zinc alloy die cast fitting designed to be screwed in by hand tool or machine
 Provides superior holding power in all wooden materials
 External split thread prevents surface expansion during insertion
 Ideal for curved surface joints and other applications where a recessed fitting is required



Item #	Finish	Description
13N-40113	Zinc	Insert Nut E 1/4:20x13mm
13N-40120	Zinc	Insert Nut E 1/4:20x20mm
13N-41125	Zinc	Insert Nut E 5/16-18x25mm

Cross Dowel (JRN)

A zinc alloy die cast or steel fitting designed for use as a right angle connector
 This fitting with a tapered guide hole to simplify bolt connection
 It is extremely torque resistant and ideal in high stress applications such as bed rails.



Item #	Finish	Description
13P-00113	Zinc	Cross Dowel 1/4-20x13mm
13P-00120	Zinc	Cross Dowel 1/4-20x20mm

Section 14 • Shop Supplies

Table of Contents

Rags	Page 14.1
Foam Protection	Page 14.1
Dust Mask	Page 14.2
Ear Plugs	Page 14.2
Stretch Wrap	Page 14.3
Pallet Wrap	Page 14.3

Rags

Ganzie 100% White cotton knit wiper. Soft, absorbent, low-lint wipers made from cotton knits such as t-shirts and finer knit materials.

Item #	Description	Pack.
14A-30000	White Ganzie Rags,	20# bag

- excellent for general clean up, where colour running or transfer is a concern
- the choice of painters, auto body repair shops, furniture finishing, fiberglass shops, or for any general cleaning application.



Foam Protection

Item #	Description	Pack.
14A-60003	Foam Roll, 36" x 900'	Roll



Dust Masks

Recommended for use when sanding, sawing, grinding, sweeping, woodworking and working with fiberglass insulating particles

Item #	Description	Pack.
14A-40002	KN95	5/Pack



Ear Plugs

Laser Lite uncorded single-use earplugs are made of self-adjusting foam that expands to fit virtually every wearer. The contoured T-shape allows for easy insertion and fit. It's smooth, soil-resistant skin prevents dirt build-up. Vibrant colors make protection visible. Pairs are individually packaged in a polybag.

Item #	Description	Pack.
14A-40100	Laser Lite Foam Ear Plugs	Box/200pr.

- ensures worksafe compliance
- NRR 32 - Noise Reduction Rating, one of the highest of any disposable earplug on the market
- easy to wear



Stretch Wrap

Item #	Description	Pack.
14A-10000	3" x 1500'	Roll

- one dispenser included in each case
- dispenser provides instant tension control that saves on film
- high quality, quiet and clear cast stretch film 3" core
- .80mil thick



Pallet Wrap

Item #	Description	Pack.
14A-40001	12.8" x 1476'	Roll

- premium resin blend, and excellent clarity ideal for scanning
- superior strength enables maximum load holding force
- unparalleled strength in lighter gauges, allowing extreme down gauge
- exceptional puncture and tear resistance, superior cling and quiet to unwind
- significant savings per pallet wrapped, minimal film usage maximum yield



Section 15 • Kitchen & Bathroom Accessories

Table of Contents

Kitchen Accessories:

Waste & Recycling Bins	Page 15.1
Sink Front Trays and Clips	Page 15.4
Sink Front Hinges	Page 15.5
Tray Dividers	Page 15.6
Bottle Holders	Page 15.7
Stemware Holder	Page 15.7
Towel Bars	Page 15.8
Lazy Susans	Page 15.8

Visit the KV website (www.kv.com)
(also linked through www.butlermarketing.ca)

or visit the Salice website (www.salice.com)



15B-65000 Base Pull Out

**Soft-Close, Bottom Mount Waste & Recycling Bins
(door-mount optional)**

Item #	Code #	Width	Height	Depth
Single Bin				
15B-71111PT	SCB 9-1-20-PT	8-3/8"	17-5/16"	20-1/8"
15B-71111WH	SCB 9-1-20-WH	8-3/8"	17-5/16"	20-1/8"
15B-71214PT	SCB 10-1-35PT	9-5/8"	18-13/16"	20-1/8"
15B-71214WH	SCB 10-1-35WH	9-5/8"	18-13/16"	20-1/8"
15B-71415PT	SCB 12-1-50PT	11-3/8"	22-7/8"	20-1/8"
15B-71415WH	SCB 12-1-50WH	11-3/8"	22-7/8"	20-1/8"
15B-71611PT	SCB 15-1-20PT	14-3/8"	17-5/16"	16"
15B-71611WH	SCB 15-1-20WH	14-3/8"	17-5/16"	16"
Double Bin				
15B-71422PT	SCB12-2-27PT	11-3/8"	18-3/4"	22"
15B-71422WH	SCB 12-2-27WH	11-3/8"	18-3/4"	22"
15B-71621PT	SCB 15-2-20PT	14-3/8"	17-5/16"	20-1/8"
15B-71621WH	SCB 15-2-20WH	14-3/8"	17-5/16"	20-1/8"
15B-71624PT	SCB 15-2-35PT	14-3/8"	18-13/16"	22"
15B-71624WH	SCB 15-2-35WH	14-3/8"	18-13/16"	22"

PT units - hardware is frosted nickel, bins platinum
 WH units - hardware and bins are white

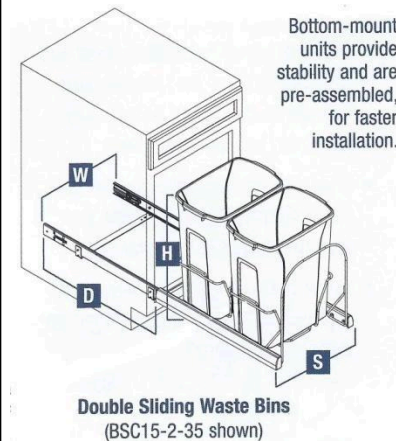

Door Mount Bracket Kits

Item #	Code #	Finish
08A-17920	AL530	Powder Coated Cream
15B-68000	PDMKTPT	Frosted Nickel



08A-17920

**Soft Close, Undermount Waste & Recycling Bins
(door-mounted)**

Item #	Code #	Width	Height	Depth
Single Bin				
15B-72414WH	USC12-1-35WH	11-13/16"	19-3/16"	22-7/16"
15B-72414PT	USC12-1-35PT	11-13/16"	19-3/16"	22-7/16"
15B-72415WH	USC12-1-50WH	11-13/16"	23-1/4"	22-7/16"
15B-72415PT	USC12-1-50PT	11-13/16"	23-1/4"	22-7/16"
Double Bin				
15B-72624WH	USC-15-2-35WH	14-5/8"	19-1/4"	22-3/8"
15B-72624PT	USC-15-2-35PT	14-5/8"	19-1/4"	22-3/8"

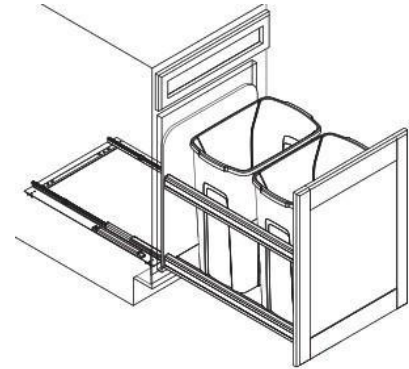

- 50 Qt. bin available by special order

**Visit KV's website to view a video on
Soft Close Undermount Slides: www.kv.com**

Replacement Bins & Lids

Item #	Code #
Bins	
15B-81020	QT20 PB-WH
15B-81120	QT20 PB-PT
15B-81027	QT27 PB-W
15B-81032	QT32 PB-W
15B-81035	QT35 PB-WH
15B-81135	QT35 PB-PT
15B-81050	QT50 PB-W
15B-81150	QT50 PB-P
15B-81060	QT60 PB-W
Lids	
15B-82020	QT20 LB-W
15B-82120	QT20 LB-PT
15B-82035	QT35 LB-W
15B-82135	QT35 LB-PT



- available by special order

Waste Recycle Pull-outs

Base Pull-out

Item #	Description	Width	Height	Depth
15B-65000	15" Base Pull-out	15"	19-1/2"	19-5/8"

- Bottom Mount
- Soft Close
- Wire Bottom
- Full Extension (500mm)
- Two 32 Qt. Plastic bins
- Handle and door brackets included
- bins are equipped with handles to keep the trash bag inside and to lift cans up
- Also available:
 - 12" wide with one 35 qt bin
 - 18" wide with two 32 qt bins
 - 21" wide with two 35 qt bins



Under Sink Pull-out

Item #	Description	Width	Height	Depth
15B-65001	12" Under Sink Pull-out	11-3/4"	15-1/16"	19-5/8"

- Bottom Mount
- Soft Close
- Wire Bottom
- Full Extension
- Two 16 Qt. plastic bins
- Lids included
- bins are equipped with handles to keep the trash bag inside and to lift cans up

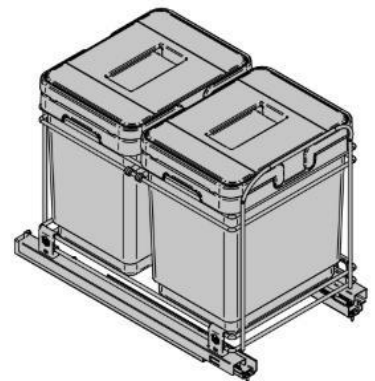

Pivot-Out Waste Bins

Item #	Colour	Description
15A-10000	White	Waste bin 15L (4GAL)
15A-10001	Chrome	Waste bin 15L (4GAL)

- patented design features an automatic lift-up lid when door opens.
- installation template allows for quick, error free mounting.
- designed for European style cabinetry



Sink Front Trays

Item #	Colour	Description	Code #	Sold By:
15B-40034	White	PVC Tray 34" long	XSF-34-10-W	Each / 10
15B-40072	White	PVC Tray 72" long	XSF-72-10-W	Each / 10
15B-43012	White	End Caps L & R and adhesive	HP-XSF-EC-20-W	Pair / 20

- trays are designed for use with hinges (see next page)
- trays do not need stops

Extruded Trays

- Stock one full length tray for all your false front needs!
- Simply cut the extruded PVC tray to length and glue the end caps into place
- Components are sold above

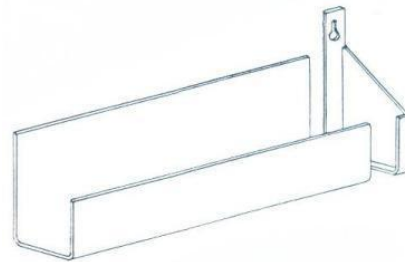

Sink Front Trays

Item #	Colour	Description	Code #	Sold By:
15B-40011	White	Tray 11" long w/ring holder	PSF11-RS-W	Each / 10
15B-40014	White	Tray 14" long w/ring holder	PSF14-RS-W	Each / 10
15B-42011	White	Tray 11" long	PSF11-W	Each / 10
15B-42014	White	Tray 14" long	PSF14-W	Each / 10

- stainless steel sink front trays available in 10 different lengths
- white sink front trays also available with no ring holder in 10 different lengths

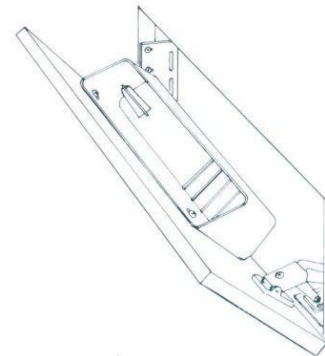

Sink Front Clips

Item #	Colour	Description	Sold By:
03D-40000	Steel	Sink Front Spring Clip	1000
03D-40050	Zinc	Sink Front Dowel 5mm	1000
03D-40055	Black	#6 Screw Mounted Sink Front Clip	1000
03D-40056	Black	Euro Screw Mount Sink Front Clip	1000

- for fastening panels to frames

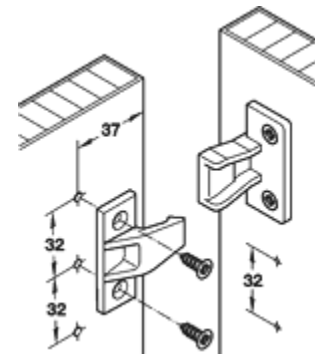
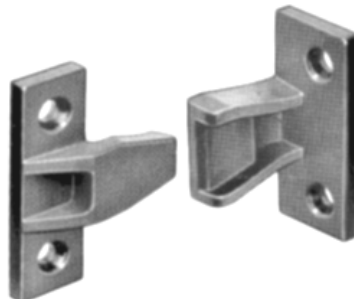
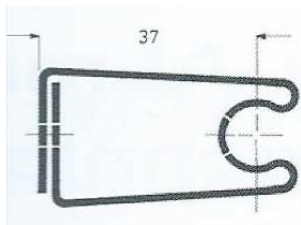

Euro Tray Hinges

Item #	Colour	Description	Code #	Sold By:
15B-41010	Nickel Plated	Sink Front Euro Tray Hinge	ET-H-N	Pair / 10

- allows for opening angle of 45° - 90°
- hinge opens flat (90°) for easy installation into existing cabinetry
- mounting plates & hinge mechanism are nickel plated
- hinges open smoothly even on long panel fronts
- fits both frame and frameless cabinets
- mounting holes provided for system 32
- slotted holes to provide adjustment

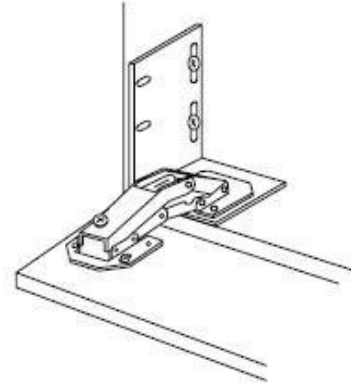

Scissors Hinges

Item #	Colour	Description	Code #	Sold By
15B-41000	Nickel Plated	Sink Front Scissors Hinge	SH-10	Pair/10

- spring loaded, self-closing, opening angle of 40°
- hinges open smoothly and evenly on any length panel
- fits both frame & frameless cabinets
- mounting holes provided for system 32
- slotted holes to provide adjustment

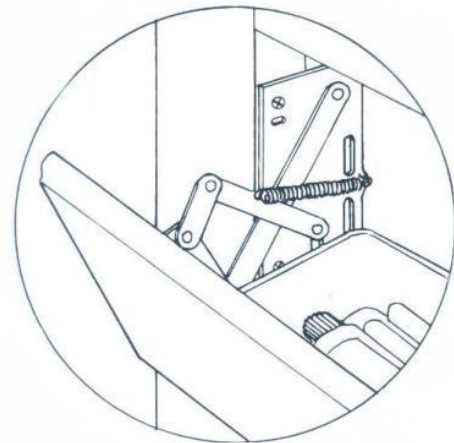

Tray Divider

Item #	Colour	Description	Code #	Sold By:
15B-20500	White	Tray Divider 12" high	TD12-W	Each / 10
15B-20502	White	Tray Divider 18" high	TD18-W	Each / 10
15C-20500	Frosted Nickel	Tray Divider 12" high	TD12-FN	Each / 10
15C-20502	Frosted Nickel	Tray Divider 18" high	TD18-FN	Each / 10

- easy to install dividers take the work out of creating a partitioned cabinet space
- 15/16" wide x 19-1/2" deep
- units are shipped complete with nylon fittings and screws
- TD-18 works well in base cabinets and TD-12 in upper pantry or oven cabinets where height is restricted



Wood & Wire Tray Divider Roll Out

Item #	Colour	Description	Code #	Sold By:
15B-20520	White	Tray Divider Roll Out 6"	TDRO6-W	Each

- fully assembled unit, easy to install
- Slides out on 1/2" thick white melamine mounted on epoxy coated roller slides
- 6" wide x 19-1/2" high x 22" deep

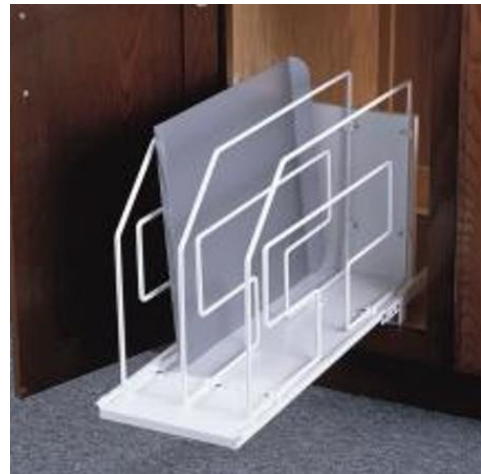

Bottle Holders

Item #	Description	Finish	Pack.
15C-71001	Single Bottle Peg	Black, Champagne Gold, Satin Chrome	Set
15C-71002	Double Bottle Peg	Black, Champagne Gold, Satin Chrome	Set
15C-71003	Triple Bottle Peg	Black, Champagne Gold, Satin Chrome	Set

- 3 lengths available for holding 1, 2, or 3 bottles
- available in black, champagne gold and satin chrome
- screw-in



Item #	Description	Finish	Pack.
15C-70360	3 Bottle Wine Rack (WR3-C)	Chrome	3 Sets

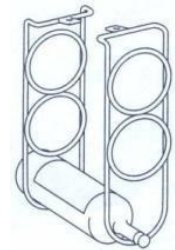

WR3

Item #	Description	Finish	Pack.
15C-72362	5 Ring Wine Rack	Frosted Nickel	5
15C-72962	6 Ring Wine Rack	Frosted Nickel	5

- easy to install. all mounting fittings are included
- two racks are required per installation, one in front & one parallel with it in the back

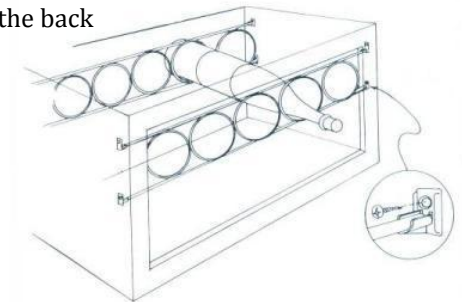

Stemware Holder

Item #	Finish	Description	Pack.
15B-70150	Brass	Single Row Stemware Holder	10

- open at both ends for access from either side
- may be placed end to end for island and certain bar applications
- 2" high

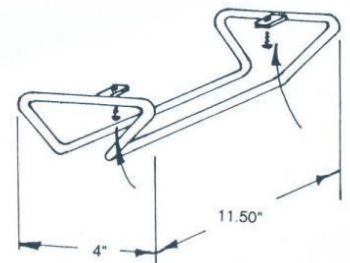

Towel Bars

Item #	Colour	Description	Code #
15B-20600	White	Towel bar	TB-W
15B-20622	Anochrome	3 prong towel bar pull out	P793-ANO

- TB-W: durable epoxy coated rack (also available in frosted nickel)
- P793-ANO includes friction free ball bearing carrier
- mounts to either left or right hand side cabinet
- 15B-20622 available by special order



P-793-ANO

of



Lazy Susans - Poly

Item #	Code #	Description	Pack.
15B-36024	PFN24ST-W	24" Full Round Polystyrene Susan	1 Set
15B-36028	PFN28ST-W	28" Full Round Polystyrene Susan	1 Set
15B-36032	PFN32ST-W	32" Full Round Polystyrene Susan	1 Set
15B-35024	PKN24ST-W	24" Kidney Polystyrene Susan	1 Set
15B-35028	PKN28ST-W	28" Kidney Polystyrene Susan	1 Set
15B-35032	PKN32ST-W	32" Kidney Polystyrene Susan	1 Set

- shelves are made of polymer (double wall rim and strengthening ribs)
- height range 25-1/2" - 31-1/2"
- mounting top and bottom
- bottom mount only available in 18" and 20" on special order

